

### Warranty Activation

To activate system warranty, Fuji Clean USA must receive Warranty Activation Card! Please see page 19.

## **INDIANA Contractor Installation Manual**

Residential Systems  
CE5, CE7, CE10, CEN5, CEN7, and CEN10  
Models

Revised: June 18, 2018



Certified to  
NSF/ANSI Standards 40 & 245



## Indiana Installation Manual Index

### TNI Approval Letter

### Sections

A. Overview and Indiana Rules .....	Page 4
B. Equipment Supplied by Contractor.....	Page 5
C. Equipment Supplied by Fuji Clean.....	Page 6
D. Installation Overview .....	Page 7
E. Treatment Process Overview.....	Page 9
F. Riser Installation.....	Page 10
G. Installation Procedure.....	Page 12
H. Control Panel Wiring Diagram.....	Page 21
I. Float Switch Information.....	Page 23
J. Start-Up Procedures.....	Page 24
K. Troubleshooting.....	Page 27
L. Fuji Clean USA Installation Procedure Checklist.....	Page 28
M. Indiana Authorized Providers .....	Page 30

### Figures

Fig. 1 Installation Layout .....	Page 7
Fig. 2 Insulation .....	Page 7
Fig. 3 Riser Height Detail .....	Page 7
Fig. 4 Optional Vent Layout .....	Page 8
Fig. 5 NSF Labels .....	Page 8
Fig. 6A and 6B Treatment Process Details.....	Page 9
Fig. 7A-7D Riser Installation Details.....	Page 10
Fig. 7E-7K Riser Installation Details.....	Page 11
Fig. 8 Uplift Restraint Detail .....	Page 13
Fig. 9 Uplift Restraint with Tie-Down Straps .....	Page 14
Fig. 10 Cable Tie-Down Detail .....	Page 14
Fig. 11 Uplift Restraint with Concrete Collar .....	Page 14

### Tables

Table 1 Iodel Specifications .....	Page 11
------------------------------------	---------

June 15, 2018

Scott Samuelson  
Managing Director  
Fuji Clean USA, LLC  
41-2 Greenwood Road  
Brunswick, ME 04011

Dear Mr. Samuelson:

Re: Approval of Fuji Clean USA, LLC CE- and CEN-Series Model units  
For use in residential and commercial onsite sewage systems

The Fuji Clean USA CE- and CEN-Series Model units listed below are hereby approved for use in Indiana as an additional system component in an onsite sewage system by the Indiana State Department of Health (department), under the provisions of *410 IAC 6-8.3-52(h)*, *410 IAC 6-10.1-49(h)*, and the *Indiana Standards for Aerobic Treatment Units* published by the department on September 8, 2015. This approval is for the use in commercial onsite sewage systems and individual residential onsite sewage systems. Approval is effective this 14<sup>th</sup> day of June, 2018.

The Fuji Clean USA Approved Models are limited to:

ATU Series	Model	Flow Rating (GPD)	Min. Flow (GPD)	BOD Rating (lbs./day)	BOD (mg/L)		TSS (mg/L)	
					Min.	Max.	Min.	Max.
CE	5	450	45	0.52	100	300	100	350
CE	7	630	63	0.73	100	300	100	350
CE	10	900	90	1.04	100	300	100	350
CEN	5	450	45	0.69	100	300	100	350
CEN	7	630	63	0.97	100	300	100	350
CEN	10	900	90	1.38	100	300	100	350

Each Model is approved for options 1.a; 1.b; 1.c; and 2.a; *Indiana Standards for Aerobic Treatment Units*, published by the department on September 8, 2015.

- I. Fuji Clean USA, LLC. is required to:
  - a) Provide tank connectors to ensure watertight pipe connections at the inlet and outlet of the treatment unit;
  - b) Certify distributors, designers, installers, service providers and those involved in permitting of these technologies;
  - c) Submit to the department a list of all certified installers, distributors, and service providers for the State of Indiana on a quarterly basis the first year and annually after that; and notify the department immediately of the removal of any certified installer, distributor, or service providers;

- d) Submit for review and approval of the department any proposed changes to any system component or the Indiana Product Manuals prior to implementation of the changes;
  - e) Notify the department in writing of any scheduled training event at least 10 working days prior to the event;
  - f) Provide on-going consultation to health department staffs, designers, installers, and service providers;
  - g) Report to the department within 30 days the failure of any owner to renew a service contract for the operation and maintenance of any onsite sewage system that includes a Fuji Clean USA CE- or CEN- Series unit.
- II. The Fuji Clean USA CE- and CEN-Series unit is subject to:
- a) The review by the department of each individual project when the unit will be subject to intermittent flows. Further, all start-up and shut down procedures must be carried out by a certified service provider after local health department notification and consultation.
  - b) The review by the department for each individual residential project where:
    - 1. A trash tank is proposed in lieu of a full sized septic tank in accordance with Section IV., *Indiana Standards for Aerobic Treatment Units* published by the department on September 8, 2015, or
    - 2. A soil absorption field of reduced size is proposed in accordance with Section VII. F., *Indiana Standards for Aerobic Treatment Units* published by the department on September 8, 2015.

Unless plan review and permit issuance has been delegated to the local health department in accordance with Section V. C., *Indiana Standards for Aerobic Treatment Units* published by the department on September 8, 2015.
  - c) The applicable provisions of ISDH Rule 410 IAC 6-8.3, and ISDH Rule 410 IAC 6-10.1, including the discharge to a soil absorption field which meets all of the provisions of the applicable rule, except for system sizing as allowed in Section VII. F., *Indiana Standards for Aerobic Treatment Units* published by the department on September 8, 2015;
  - d) Treating only domestic and/or residential strength wastewater;
  - e) The applicable provisions of *Indiana Standards for Aerobic Treatment Units* published by the department on September 8, 2015;
  - f) The Fuji Clean USA Indiana Design, Contractor Installation, Operation and Maintenance, and Owner's Manuals; and
  - g) The provisions and criteria identified in this approval letter.
- III. The Fuji Clean USA CE- and CEN-Series aerobic unit manufacturer, designer, distributor, installer, and service provider is subject to:
- a) Fuji Clean USA, LLC Certification;
  - b) Maintaining a status of good standing with Fuji Clean USA, LLC.

This approval may be revoked or modified by the department for non-compliance, or if it is documented that it would not be in the best interests of public health for approvals to continue.

If you wish to request administrative review of this *Approval* pursuant to Indiana Code 4-21.5-3-5, you must file a petition for review within fifteen (15) days after this *Approval* is received. The petition for review and petition for stay of effectiveness must be postmarked no later than July 10, 2018.

The petition for review must be in writing and must include facts demonstrating that:

- The petitioner is a person to whom the *Approval* is specifically directed;
- The petitioner is aggrieved or adversely affected by the *Approval*; or
- The petitioner is entitled to review under any law.

If the petition for review is not filed timely, this *Approval* becomes FINAL. Any petition for review and petition for stay of effectiveness must be submitted in writing to:

Court Administrator  
Office of Legal Affairs, #3H  
Indiana State Department of Health  
2 North Meridian Street  
Indianapolis, IN 46204

If you do not object to this product submittal approval, you do not need to take any further action.

Sincerely,

A handwritten signature in blue ink, appearing to read "m. mettler".

Michael Mettler, REHS, Director  
Environmental Public Health Division  
317/233-7183  
mmettler@isdh.in.gov

cc: Bennette D. Burks, P.E., AOSE, Fuji Clean USA, Technical Advisor for Indiana Approval  
Local Health Departments  
Onsite Staff



## A. Overview and Indiana Rules

Fuji Clean USA (Fuji Clean), residential wastewater treatment systems have been approved in Indiana as Aerobic Treatment Units (ATU) for new and replacement/repair installations. Indiana designs that incorporate Fuji Clean technology shall include the following:

1. All system designers, installers and service providers must be Indiana Fuji Clean USA certified. Training is available on a regular basis in Indiana through Fuji Clean USA's Authorized Representative.
2. Design must be in compliance with the manufacturer's manuals, Indiana State Department of Health (ISDH) Rule [Indiana Standards for Aerobic Treatment Units (ATU)], 410 IAC 6-8.3 and 410 IAC 6-10.1] and any applicable Local Health Department policies, and Local Ordinances.
3. Fuji Clean's TNI Approval Letter, with approved models, is included with this document. (Also on Department's website; "Approved TNI").
4. Fuji Clean's treatment system model selection shall be based on the Design Specification Summary in this Indiana Design Manual.
5. Fuji Clean ATU's will only accept sewage as defined in 410 IAC 6-8.3-41 and in 410 IAC 6-10.1-38.
6. Design will stipulate that water softener backwash shall not enter the Fuji Clean ATU and be managed by an option approved by the ISDH rules.
7. System O&M must be performed by an authorized service provider according to the requirements of the SI O&M program.
8. Soil Absorption system design shall meet or exceed the provisions of Rule 410 IAC 6-8.3, 6-10.1 and Indiana TNI Standards for the specific soil absorption field technology. A Fuji Clean unit utilizing a conventional soil absorption field technology may qualify for a 33 percent reduction in absorption field sizing.
9. Insulation shall be used per the Fuji Clean Installation Manual.
10. CAD and PDF drawings of systems are available at the website: [www.fujicleanusa.com](http://www.fujicleanusa.com)

**Please contact Fuji Clean USA or its Indiana Authorized Representative  
with questions or for additional technical information.**

# Contractor Installation Manual – Residential Systems

## B. Equipment Supplied by Contractor

### **Risers and Covers per Site & Regulatory Requirements**

*Note: Tuf-Tite Risers in 6" or 12" height increments and covers are available from your distributor or Fuji Clean USA. If not already installed, please refer to page 5 for installation instructions.*

**Model CE5:** Three (3) Tuf-Tite 20" Risers

**Models CE7, CE10 and CEN Series:** Two (2) Tuf-Tite 20" Risers plus One (1) 24-inch Riser and One (1) Tuf-Tite 24-RTT Adaptor and Two (2) Tuf-Tite RTR Adaptors (optional) for height parity.

### **Insulation Against Frost**

Fuji Clean units must be protected against frost penetration in accordance with Indiana Table VIII—Frost Penetrations in Indiana. See Page 12 for specific details.

### **Septic Tank and/or Pump Station.**

If local code or site conditions mandate. Fuji Clean system are designed to accept typical domestic sewage.

### **Fresh Water**

Systems must be filled with fresh water to Low Water Mark (LWM) before start-up. Approx. gallons required per model: (CE5: 435; CE7: 610; CE10: 925; CEN5: 610; CEN7: 925; CEN10: 1,230).

### **Piping/Conduit**

- 4" inlet and outlet lines per 410 IAC 6-8.3-67 Pipe Specifications.
- ¾" PVC conduit for air line.
- Electrical conduit for float switch line (or use direct burial line).

### **Electrical**

- Please adhere to applicable national/local electrical code(s).
- Two (2) standard 115V, 15A circuits for control/alarm panel connection.
- Float Switch Wire: #18 AWG (comes with standard if extension <50-ft. is required).
- Float Switch: Comes pre-installed in treatment system. For electrical hookup, please refer to SJE Rhombus installation instructions.
- Miscellaneous fittings and connectors to assure watertight connections.

### **Anti-Float Devices, if necessary**

- Please refer to high water, anti-float recommendations on page 8 of this manual.

### **Materials for Blower / Controller Installation**

- Concrete base (or equivalent) on which to set air blower.
- Protective cover for air blower (vented and able to achieve free airflow in all conditions).
- Materials or location on which to mount control panel and protect from elements.

### **Crushed Stone, Fill, Loam etc.**





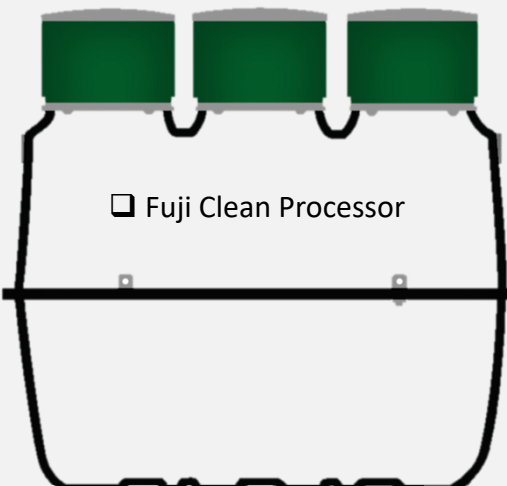

- Fuji Clean USA is not responsible for design, installation or materials associated with leachfield or treated wastewater disposal area. Please refer to Fuji Clean USA Indiana Design Manual.

**Please note: Proper installation permitting is the responsibility of the installing contractor.**

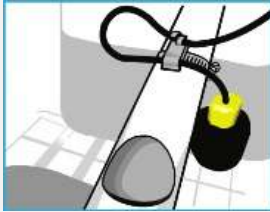
### C. Equipment Supplied by Fuji Clean USA

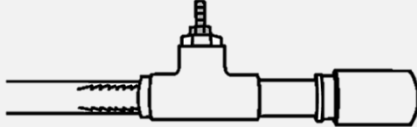
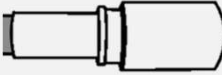
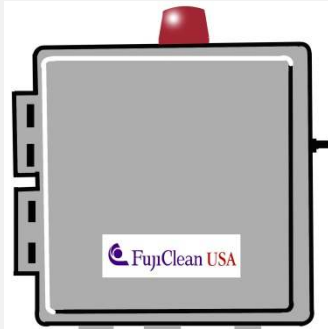
Thank you for choosing to install a Fuji Clean USA treatment system. We care that the system is installed properly and thoughtfully. Fuji Clean USA or your qualified distributor will train and certify you for proper installation. PLEASE contact your distributor or Fuji Clean USA for assistance or with ANY questions.

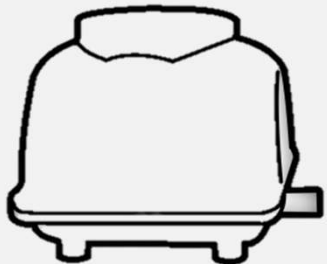

- Fuji Clean Processor
- SJE Rhombus Signalmaster Float Switch (Center chamber with 3-1/2" tether). 
- Air Vent Plug 
- Blower Adaptor Fitting with Barb 
- Tank Adaptor Fitting 
- NEMA 4X Rated Alarm/Controller 
- Installation Manual
- Owner's Manual
- NSF 40/245 Data plates as Required 
- Fuji Clean MAC "R Series" UL Approved Air Blower 
- 1/8" (ID) Vinyl Micro-Tubing for Air Pressure Sensing Alarm 



# D. Installation Overview

**Figure 1. Installation Layout**

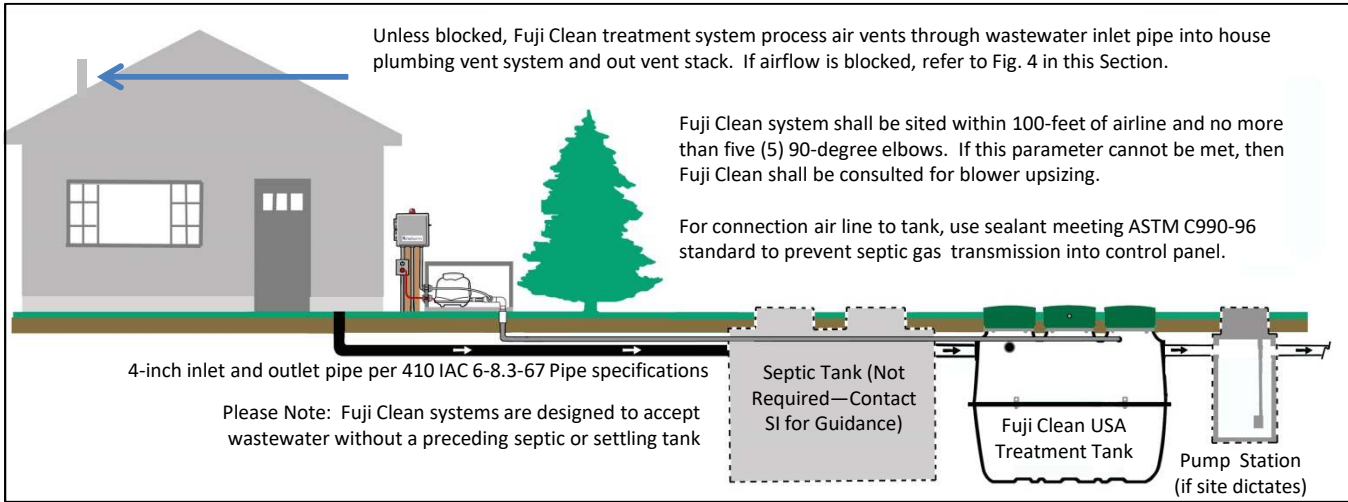

**Figure 2. System Insulation**



Insulate systems for Indiana sites as specified in the Fuji Clean USA, Indiana Installation Manual. Frost protection for the upper half of the tank is provided by insulation board (“blueboard”) with minimum R-8 insulation value. Please refer to the Fuji Clean Indiana Installation Manual for installation details.

Alternative insulation options must be approved in writing by the Indiana authorized Fuji Clean representative.

**Figure 3. Riser Height Detail**

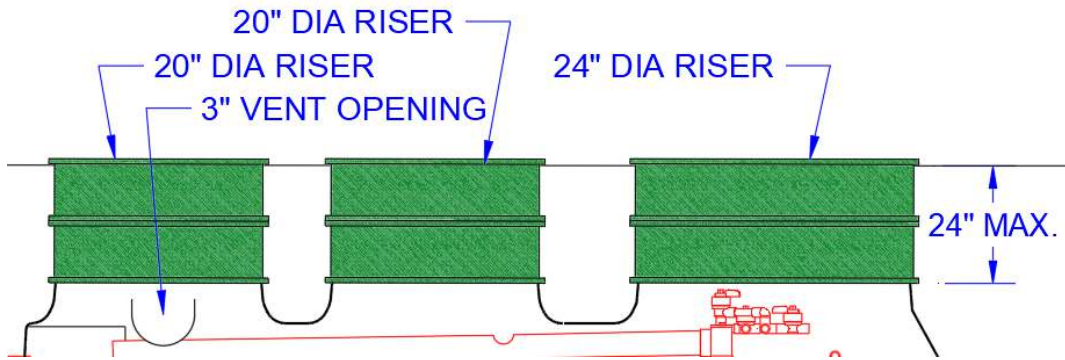

- System is delivered with risers.
- Riser additions may be installed by contractor but total riser height shall be no more than 24" to allow service access.
- Note: Model CE5 requires three 20" diameter risers. All other Fuji Clean systems require two 20" diameter riser and one 24" diameter riser as shown.

## D. Installation Overview, cont.

**Figure 4. Optional Vent Layout**

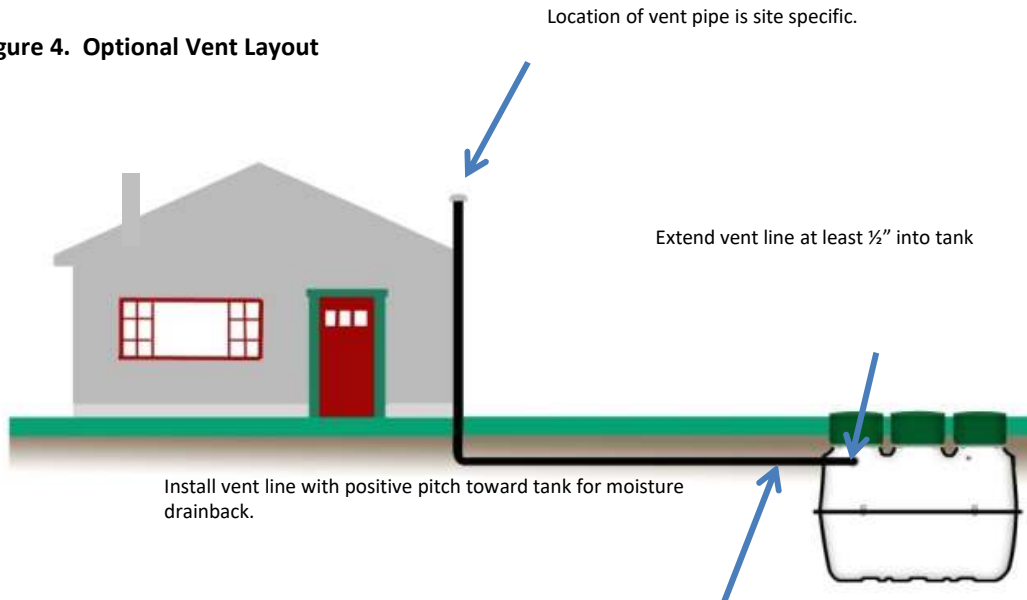

- Please refer to Fig. 1 for standard system venting through house plumbing.
- If access to house plumbing vent system is blocked (for example from effluent or grinder pump from house to system), a separate 3" PVC vent line must be installed. A pre-drilled 3" hole for this vent is included with all Fuji Clean systems. (A 3" plug is provided if this vent is not installed.)
- Vent line shall be installed with a watertight grommet or equivalent and extend no less than 1/2" into Fuji Clean tank. Vent shall be installed with continuous positive pitch toward tank so that any accumulated moisture will drain into tank.

**Figure 5. NSF Labels**

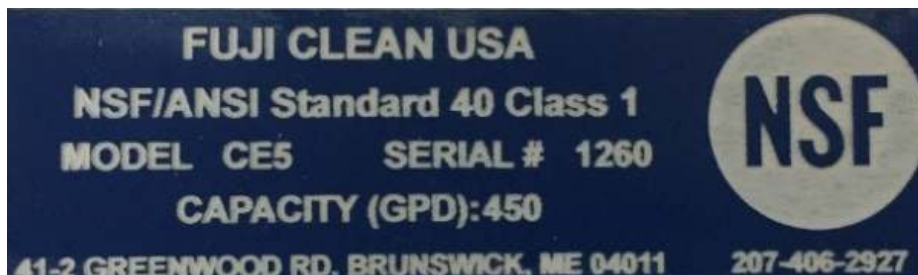

Using grommets or waterproof adhesive, NSF labels (supplied by Fuji Clean), shall be affixed in two locations, inside one riser and on inside of controller.

## E. Treatment Process Overview

Fuji Clean's "contact filtration" treatment is a simple, well engineered process that consists of a controlled, circuitous flow train through anoxic and aerobic chambers and in direct contact with assorted proprietary fixed film medias on which biological digestion of organic matter occurs. Media is also designed and positioned to provide mechanical filtration of process wastewater.

The system includes two air lift pumps (see diagram below) The Recirculating Airlift Pump returns process water and sludge from the aerobic zone to the sedimentation chamber, recirculating 2-4 times inflow per day for CE models and 4-6 times inflow for CEN (enhanced denitrification) models. The Effluent Airlift Pump is designed to help equalize flow and discharge treated effluent.

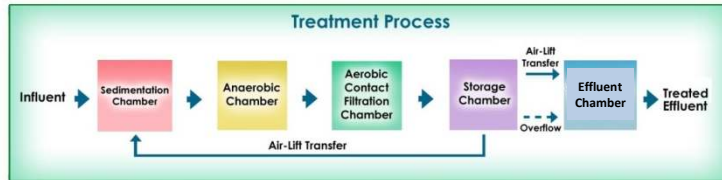

**Two Air Lift Pumps.** One Recirculating Air Lift pump sending process water and solids back to Chamber 1, and one Effluent Air Lift Pump for measured discharge of treated effluent. (See airlift pump info below).

**Chamber 3A. Storage Chamber**

**Sludge Transfer**  
(Recirculating air lift pumpback)  
See airlift pump info below.

Inlet

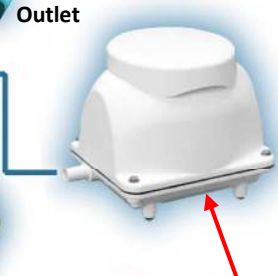

**Powered by the MACBlower "R" Series Blowers** State-of-the-art linear diaphragm air blowers manufactured by Fuji Clean Co sized to provide about 2.8 cubic feet per minute to most residential systems.

**Chamber 3. Aerobic Contact Filtration Chamber**  
(both board and cylindrical hollow mesh media) oxygen rich zone for aerobic microbe digestion activity, solids filtration and nitrification of ammoniac nitrogens to nitrates

**Chamber 1. Sedimentation Chamber** (separates solids and greases)

**Chamber 2. Anoxic Contact Filtration Chamber** (spherical-skeleton filter media) organic matter decomposition by micro-organisms, suspended solids captured and nitrates are denitrified

Figure 6. Treatment Overview

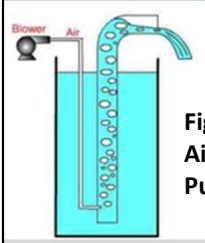
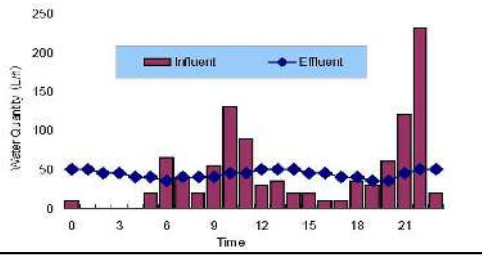
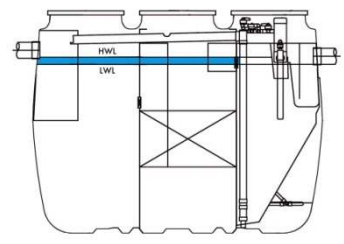

Figure 6A. Airlift Pumps

**Airlift Pumps.** This generic illustration shows the mechanics of the "airlift pumps" used in this system, which are simple pipe conduits through which pressurized air (from blower) is introduced at the bottom and by fluid pressure, water is carried up the pipe by ascending bubbles.

Figure 6B. Flow Variability Accommodation

Water level rises and falls between LWL and HWL in the first two chambers smoothing out inflow fluctuations.



## F. Riser Installation

Please note: Systems typically are delivered with risers pre-installed. These instructions are provided only in cases where risers are not in place. Fuji Clean systems accept Tuf-Tite brand risers.

**Figure 7A.**

Trim tab struts (on 6" Tuf-Tite risers) with vibrating cutting tool and apply mastic or caulk along inside as shown. (Note: Sealant must meet at least ASTM C990-96 Standard).



**Figure 7B.**

Apply sealant for watertight seal.

**Please Note! Shown with removed gray cover adaptor. Use end nipper pliers to cut plastic rivets. (Note: adaptors can be left in place for 20" openings – contractor's choice)**



**Figure 7C.**

Secure with stainless hardware.

**Figure 7D.**

Press down until tabs are flush with access port rim.



## F. Riser Installation, Con't.

After the Tuf-Tite 24-RTT adaptor is used, adjust for riser height differential on the remaining two 20-inch access ports using a Tuf-Tite 20-RTR Adaptor (provided by distributor) secured to the top of each riser. Please Note: Gray Fuji Clean adaptor and covers may be used or green Tuf-Tite covers as desired.



**Figure 7E.**  
Attaching Tuf-Tite 20-RTR Adaptor



**Figure 7F.**  
Tuf-Tite 20-RTR Adaptor Attached



**Figure 7G.**  
Adjusting Riser Height



**Figure 7H.**  
Final Riser Adjustment

Two alternative riser configuration options are shown. The first includes using the Tuf-Tite risers installed and secured to the tank in an upside down configuration and then using the gray Fuji Clean adaptor ring and Fuji Clean cover as shown. The second (good for 20" risers only), shows an intact adaptor ring.



**Figure 7I.**  
Tuf-Tite Riser with Fuji Clean cover



**Figure 7J.**  
Tuf-Tite Riser with Fuji Clean cover—alternate view

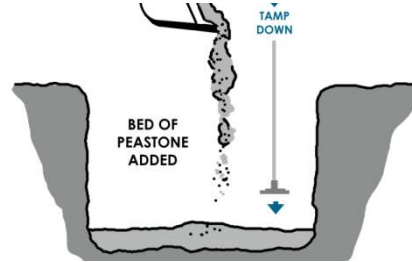
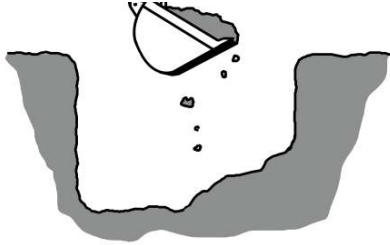

**Figure 7K**  
Use sealant that meets ASTM C990-96 Standard here.

## G. Installation Procedure

### Unloading Instructions:

- Upon delivery, inspect Fuji Clean tank, both outside and inside for possible damage incurred during transport. If you find damage, or have a question, please contact your distributor immediately.



- **Step 1:** Prepare excavation to be at least 1 to 2 feet larger than Fuji Clean system dimensions as listed below. **Important Note:** Riser height shall not exceed 24".
- **Step 2:** Prepare 4"- 6" bed of stone (¼" to ½"), or sand level to within 1/8".

FUJI CLEAN USA Indiana Specifications	TABLE 1—MODEL SPECIFICATIONS			CEN Series BOD, TSS, Enhanced TN Removal			
	Model	BOD, TSS, TN*			CEN5	CEN7	CEN10
Bedrooms		3	4	6	3	4	6
Design Daily Flow (GPD)**		450	630	900	450	630	900
<b>Tank Detail:</b>							
Height (inches)		61.8	65.7	73.6	65.7	73.6	77.4
Length (inches)		85	95.7	98.8	95.7	98.8	118.9
Width (inches)		43.7	49.2	56.7	49.2	56.7	68.9
Weight (lbs.)		397	463	705	463	705	926
Inlet Invert (inches, rounded to 1/8")		49	53	61	53	61	77.25
Outlet Invert (inches, rounded to 1/8")		47	51	59	51	59	75.25
Access Ports (number)		3	3	3	3	3	3
Access Port Diameter (inches)		3@20"	2@20" 1@24"	2@20" 1@24"	2@20" 1@24"	2@20" 1@24"	2@20" 1@24"
Volume Total (gallons)		540	749	1069	749	1069	1498
Uplift Restraint (lbs./In)****		77	100	127	100	127	170

- **Step 3:** Carefully lower and set tank. Level to within 1/8-inch.

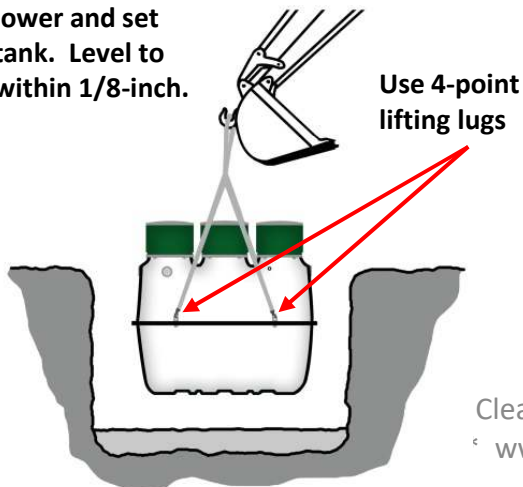

- **Step 4:** Uplift restraint is required for tanks installed below saturated soils. The weight of the uplift restraint will depend on how deep below the water table the unit is placed. Table 1 provides the uplift per inch for each model. The uplift required is calculated by multiplying the appropriate Uplift restraint by the height from the tank base to the top of the water table.

**Figure 8. Uplift Restraint Detail (Hardware provided by Indiana distributor)**

**Note: Deviations in uplift restraint selection must be approved in writing by Fuji Clean USA, LLC, prior to installation.**

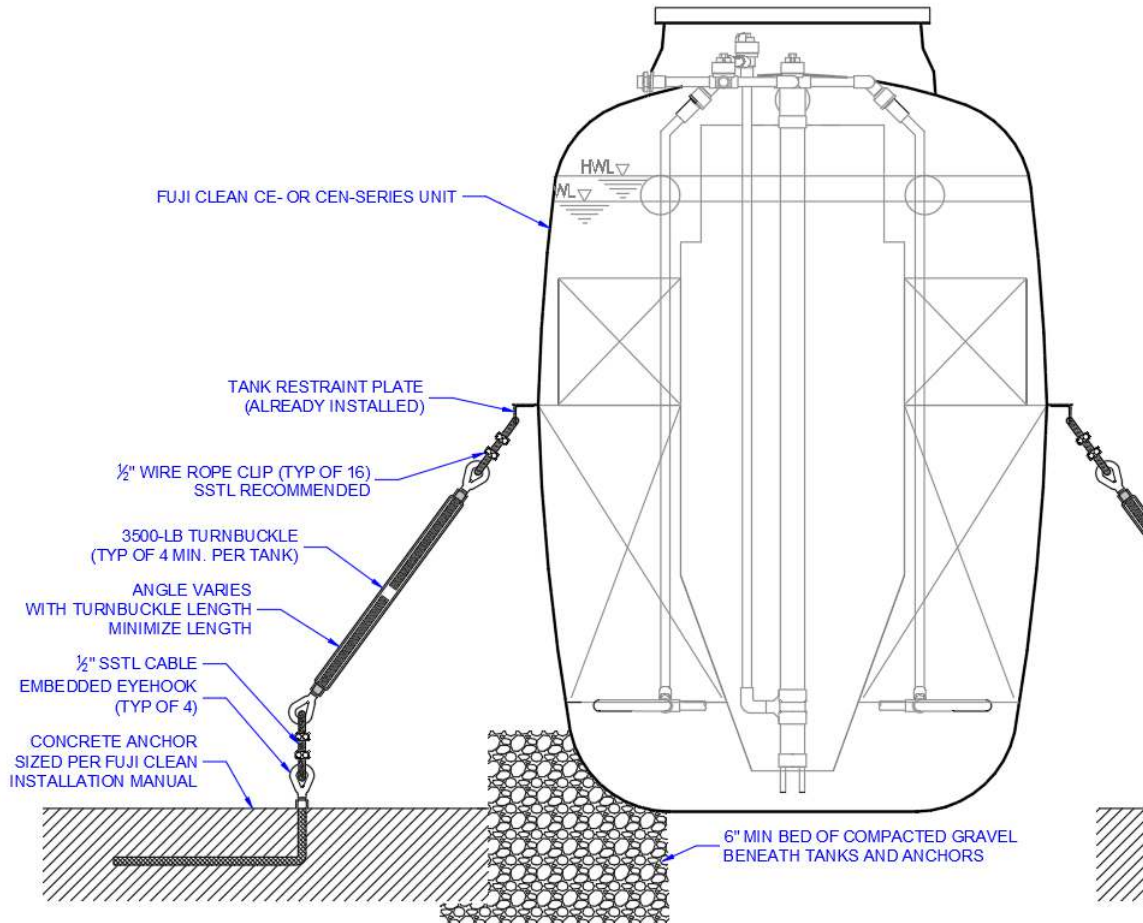

**Figure 9. Uplift Restraint with Tie-Down Straps**

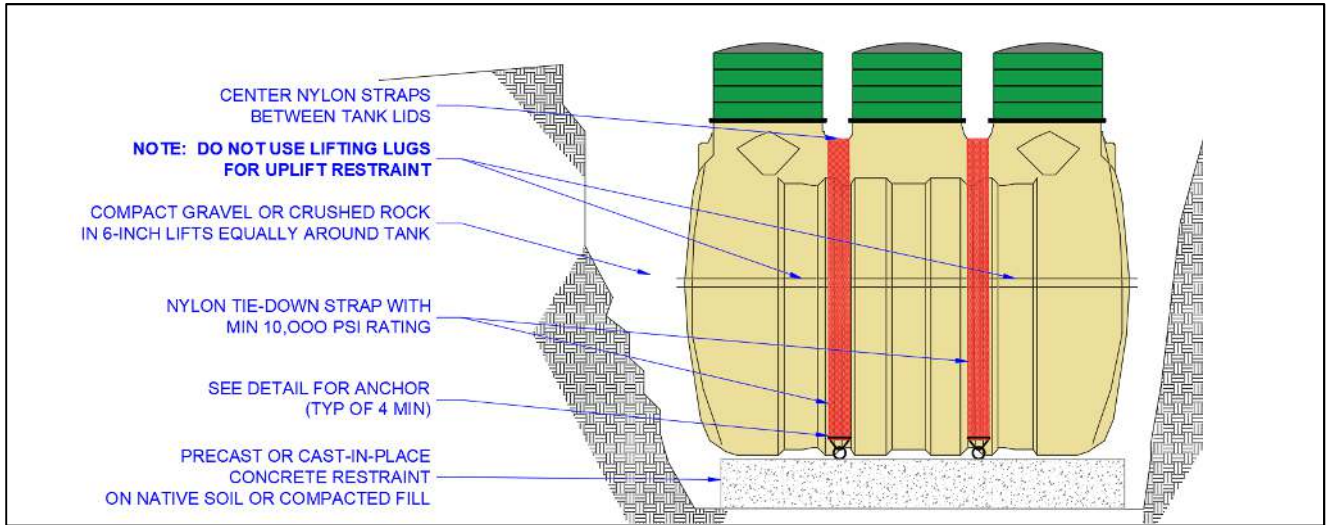

**Suggested uplift restraint configurations include tie-down straps using concrete restraints or concrete collar.**

**Note: tie down straps and 1/4" SSTL cable are commodity items and not brand specific.**

**Figure 10. Cable Tie-Down Detail**

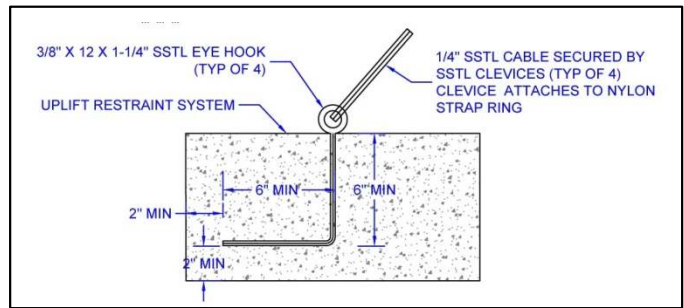

**Figure 11. Uplift Restraint with Concrete Collar**

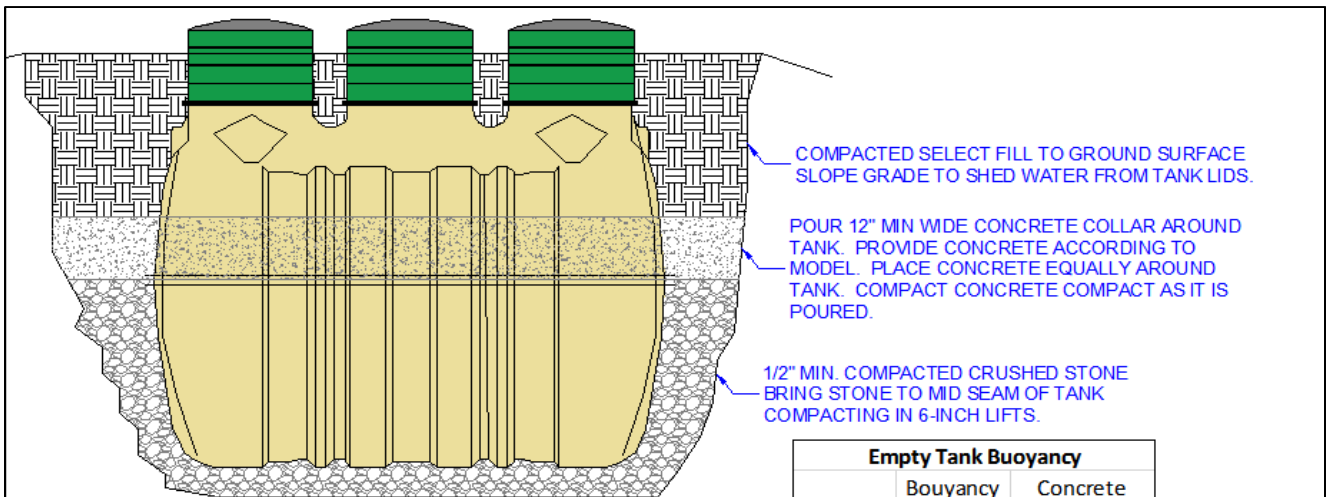

**Notes:**

1. "CY" means cubic yards.
2. Concrete shall be compacted by "rodding" or vibrator during pouring.
3. Excavation shall be free of water.

Empty Tank Buoyancy		
Model	Buoyancy (lbs)	Concrete Restraint (CY)
CE5	5,270	1.30
CE7	7,210	1.78
CE10	10,400	2.57
CEN5	7,210	1.78
CEN7	10,400	2.57
CEN10	14,500	3.58



- Step 5: After rechecking that tank is level to 1/8-inch, (fore and aft as well as side-to-side), fill tank with potable water to the low water line mark. Well and surface water is acceptable for this step. (Note: Alternate chambers while filling for evenly balanced fill. ) To assure tank water tightness, Fuji Clean requires that you check that water level after 24 hours. Please contact your distributor or Fuji Clean USA if water level has dropped.

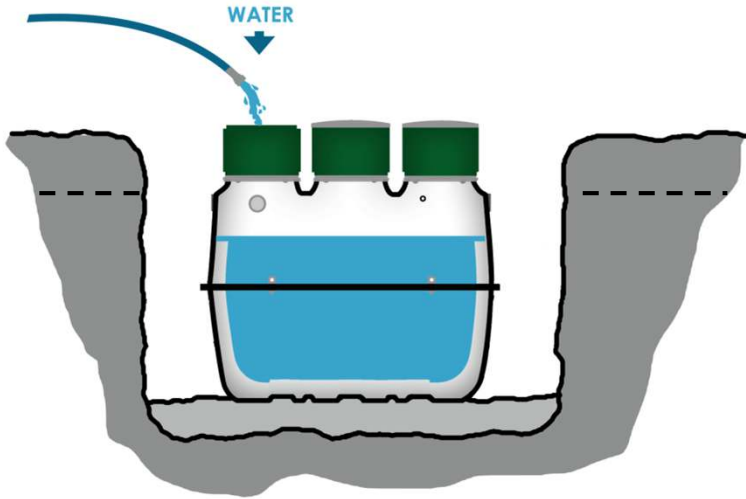

Low water line in sedimentation chamber

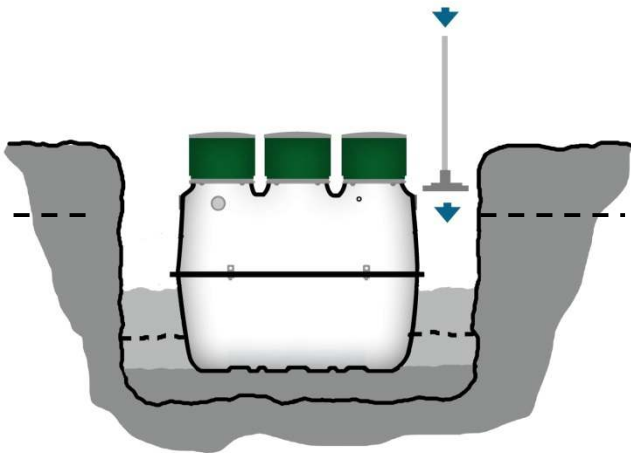

- Step 6: Backfill about ¾ way up tank in layered, compacted 6" lifts using pea stone or equivalent material that form-fits into tank corrugations. INDOT Spec 23 sand equivalent and native sand are both acceptable.

- ❑ **Step 7: Using supplied adaptors and fittings, attach air pipe fitting to tank and connect to 3/4" Sch 40 PVC ASTM D 2466 conduit and fittings in prepared trench (min. 6" deep) to location of air blower. Please note: 3/4" flexible tubing, 100 PSI Max, may also be used for the airline.**

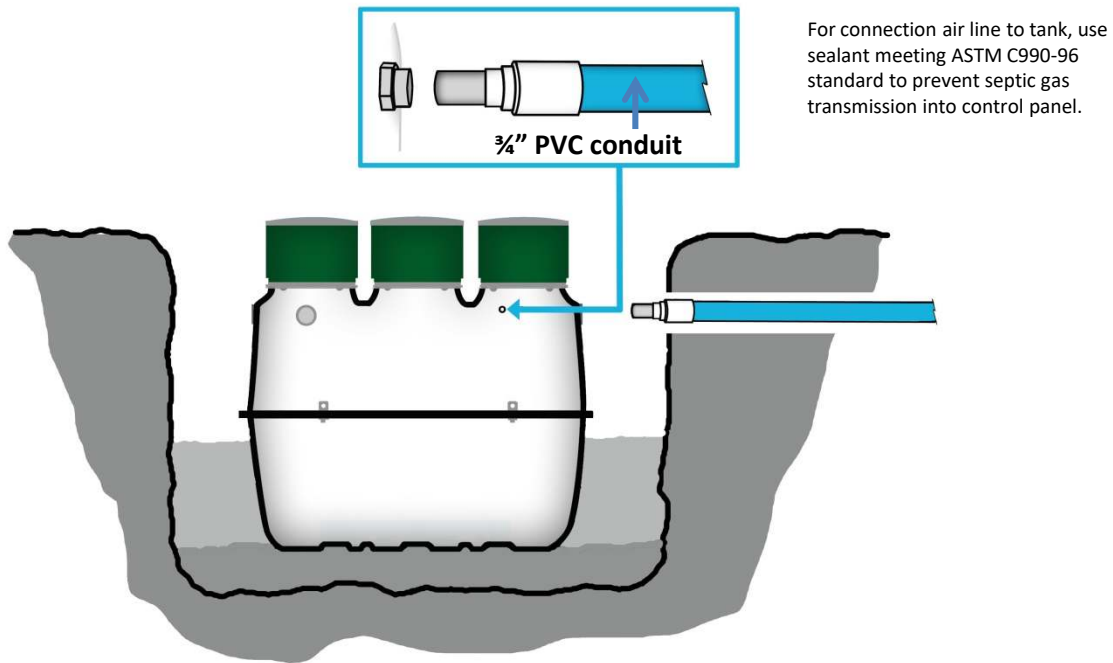

- ❑ **Step 8: Locating and Installing Blower/Control Panel.**

- ✓ **USING 3/4-INCH CONDUIT, LOCATE BLOWER WITHIN 100-FT. OF TREATMENT TANK AND WITH NO MORE THAN FIVE (5) ELBOWS. If site conditions prevent this, please contact your distributor or Fuji Clean USA for technical assistance.**

**Air Blower shall be:**

- ✓ as close to the control panel as possible
- ✓ on a solid (e.g. concrete) pad to minimize vibrations
- ✓ in a flood-proof location (blower cannot be submerged)
- ✓ away from grease exhaust fans.
- ✓ away from bedroom windows and other locations where operational sounds (although minimal) may be a nuisance
- ✓ In a location that allows unencumbered access for inspection and maintenance activity
- ✓ with proper electrical grounding
- ✓ with wiring and electrical connections made - all adhering to applicable electrical code
- ✓ with no objects on top of electrical cord.
- ✓ in a well-ventilated space out of direct sunlight and protected from elements such as direct rain or snowfall.

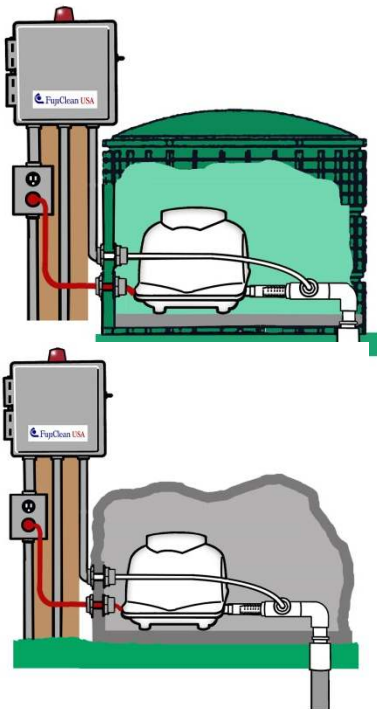

Two common methods to cover a blower covers include a pad, riser, and lid combinator and artificial stone. Be sure to vent the enclosure.

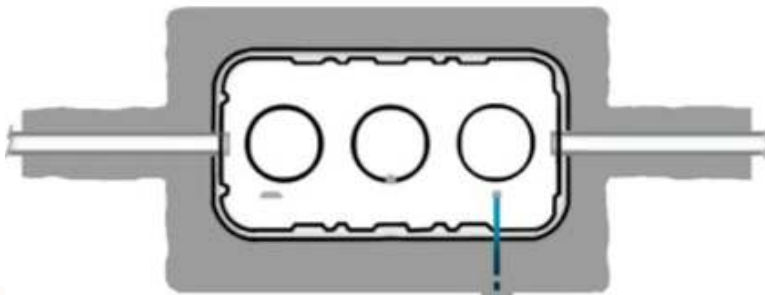

Plan view shows trench excavations for inlet and outlet lines

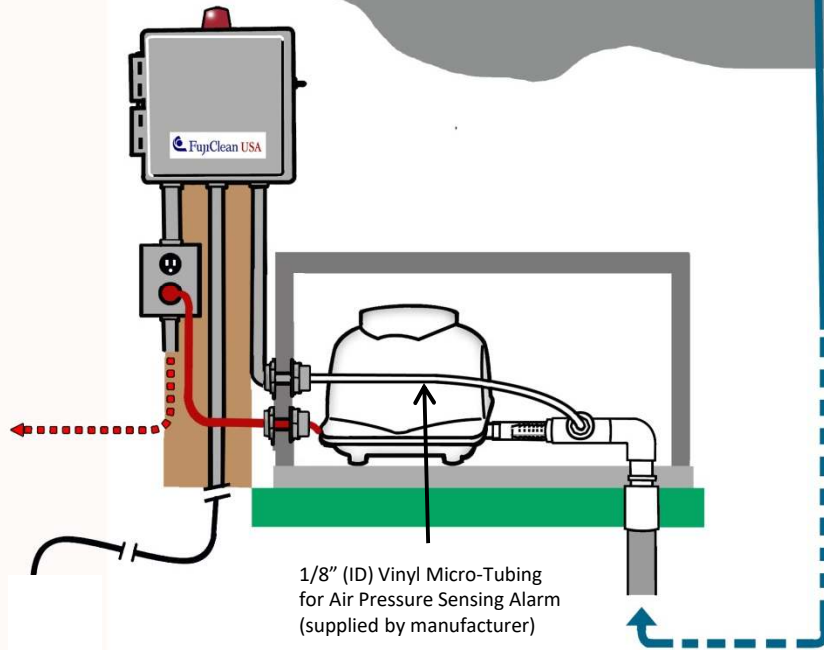
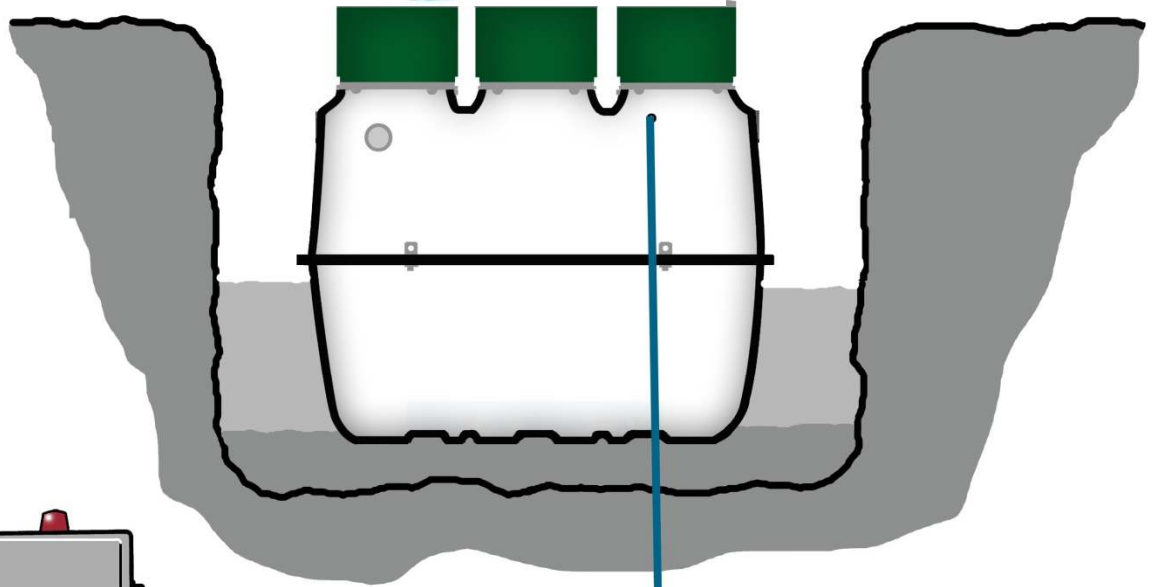

❑ Step 8 continued: Locating and Installing Blower/Control Panel cont.

Alarm Panel shall be:

- ✓ in a well-ventilated area as dry and protected from elements as possible
- ✓ as close to **MACBlower** as possible
- ✓ wired by licensed electrician, if required, or electrician qualified by Fuji Clean if no license is required
- ✓ in a location that allows unencumbered access for inspection and maintenance activity

❑ For additional important detail about installing and maintaining blower, please review and refer to provided **MACBlower Installation-Maintenance Manual**, which is provided inside the blower box.

- **Step 9: Install insulated risers and covers and cover upper half of treatment unit with min. R-8 value insulating material (i.e. 2" foam blueboard).**

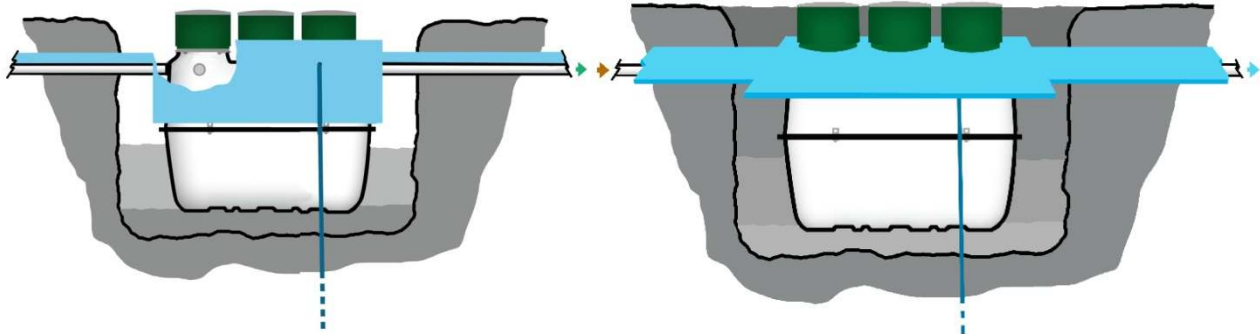

Blueboard insulation may be form fitted directly to tank or placed horizontally extending four 4ft. from tank edge. Both insulating techniques are acceptable.

- Step 10: Float switch electrical cord should exit riser wall through a male adaptor (caulked watertight to prevent septic gas leakage) or watertight fitting.**

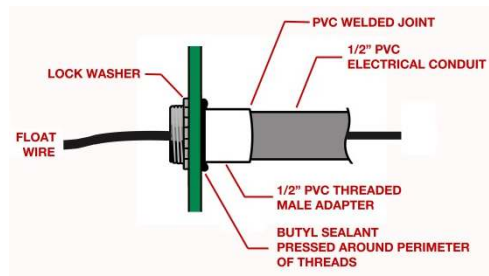

For connection of float switch cord to alarm panel, drill hole in riser and use male fitting and electrical conduit. Plug fitting with sealant standard that meets ASTM C990-96 to assure water-tight seal and to prevent septic gas transmission into control panel.

- **Step 11: Prepare Tank Inlet and Outlet for 4" inlet and outlet lines per 410 IAC 6-8.3-67 Pipe Specifications.**



**Seal around inlet and outlet tank fittings using a sealant that meets ASTM C990-96 standards**



**Apply primer and cement to 4" Sch 40 PVC (ASTM D2466) inlet and outlet pipe sections**

- ❑ **Step 12:** In nearly all cases, the Fuji Clean system will vent properly through the house septic influent line. In cases where there is a influent pump that blocks access to building vent system, or in severe downdraft locations, a separate vent should be installed. When installing a vent, be sure that the vent pipe slopes toward the tank so that any moisture accumulation drips back down toward the tank.

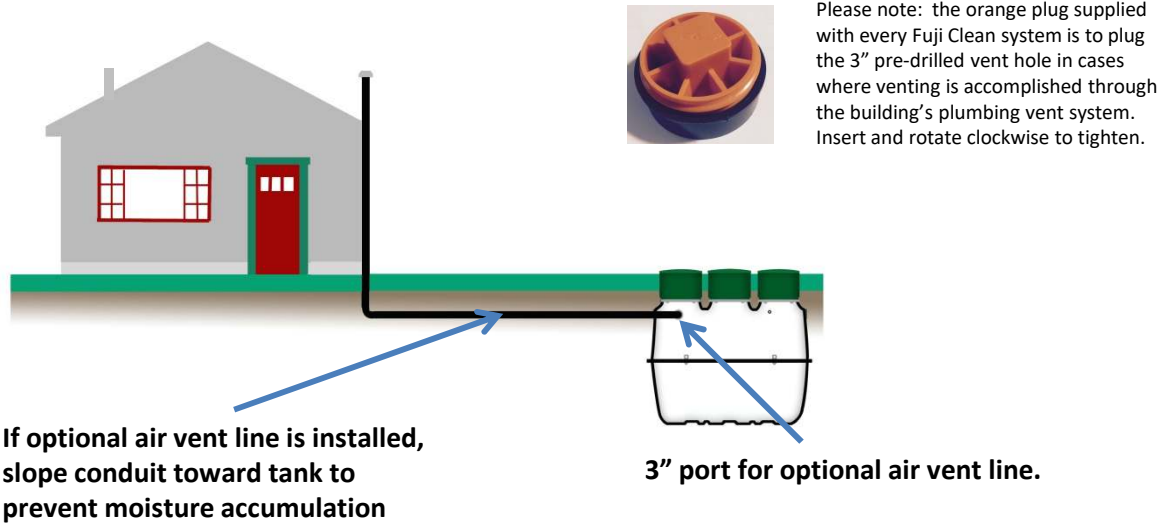

- ❑ **Step 13:** During final landscaping, seeding etc., be sure to pitch final grade away from covers to sweep surface water away from treatment tank.

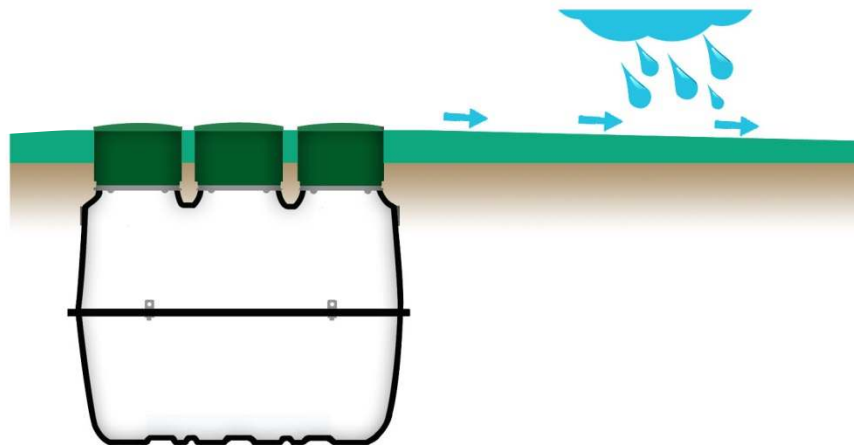

- ❑ **Step 14:** Fill out Warranty Activation Card (received with this Installation Manual) and return to Fuji Clean USA to activate system Warranty. If this card cannot be found, please contact Fuji Clean USA for voice or online Warranty activation. 207-406-2927.

- ❑ **Step 15: Finalize Controller Wiring.** Please refer to wiring diagram in this manual and enclosed separately in alarm/control panel. Upgraded Fuji Clean USA controllers are available with additional capabilities such a telecommunication capacity, flow monitoring etc.. Please contact Fuji Clean USA for details.

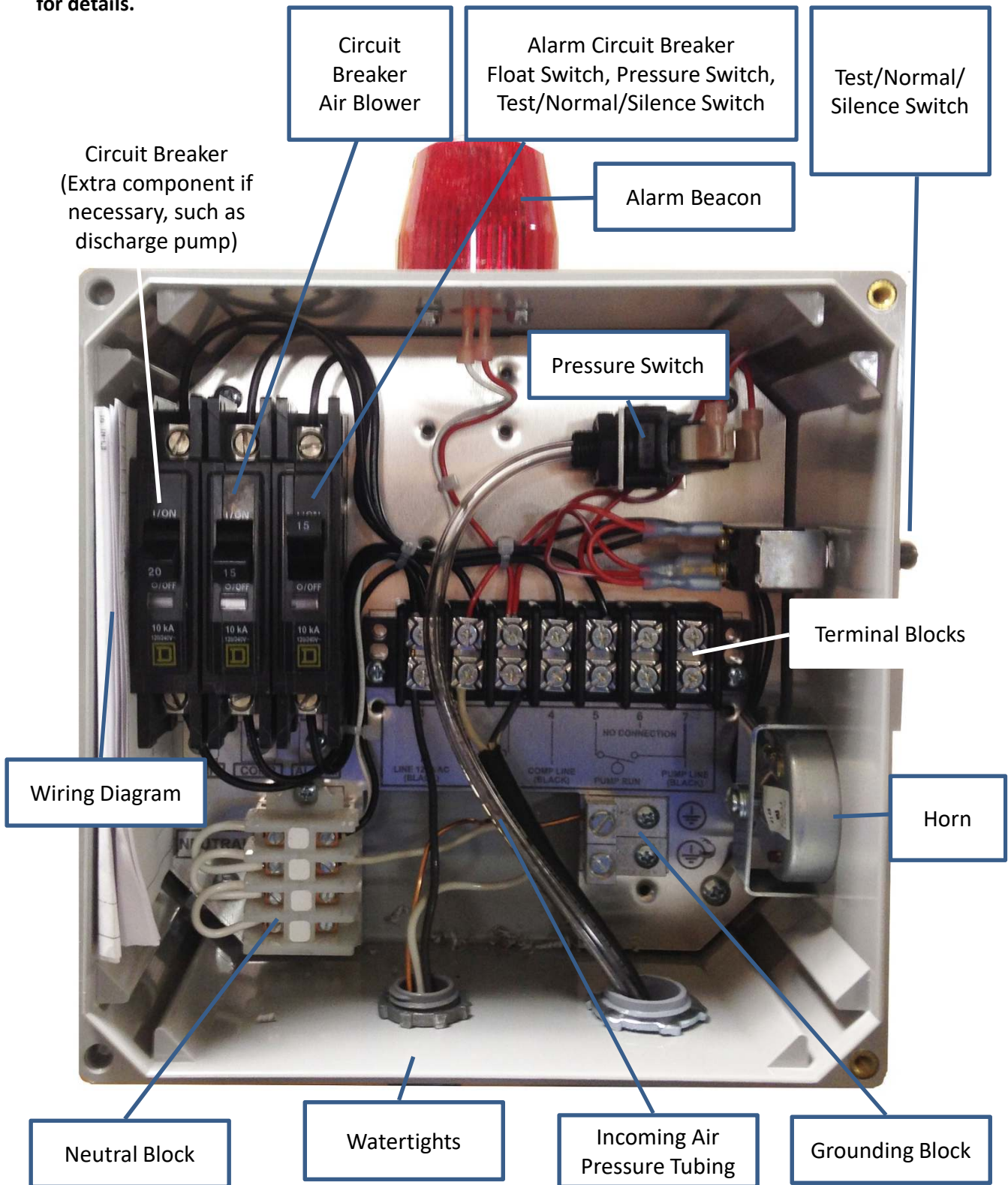

## H. Control Panel Wiring Diagram p.1

Please provide wiring diagram to the licensed electrician, if required, or electrician qualified by Fuji Clean if no license is required for making proper electrical connections. (A copy of this diagram is also provided inside NEMA 4X rated control panel enclosure).

Please Note: The basic Fuji Clean control panel does not come equipped with a timer or timing device. Please contact your distributor for this and other alarm/controller upgrade options.

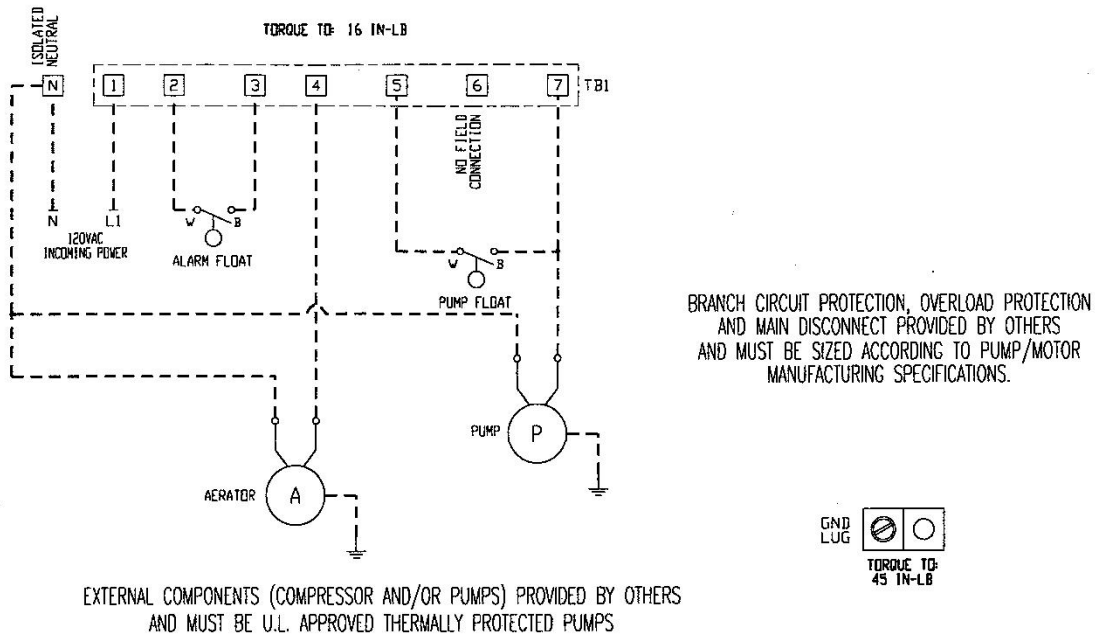

TEMPERATURE RATING OF FIELD INSTALLED CONDUCTORS MUST BE AT LEAST 140 DEG. F. (60 DEG. C.). TERMINAL STRIPS AND GROUND LUG USE COPPER CONDUCTORS ONLY.

CONNECT GROUND LUG IN PANEL TO A SECURE EARTH GROUND

DASHED LINES REPRESENT FIELD WIRING

FIELD WIRING SECTION

# Control Panel Wiring Diagram p.2

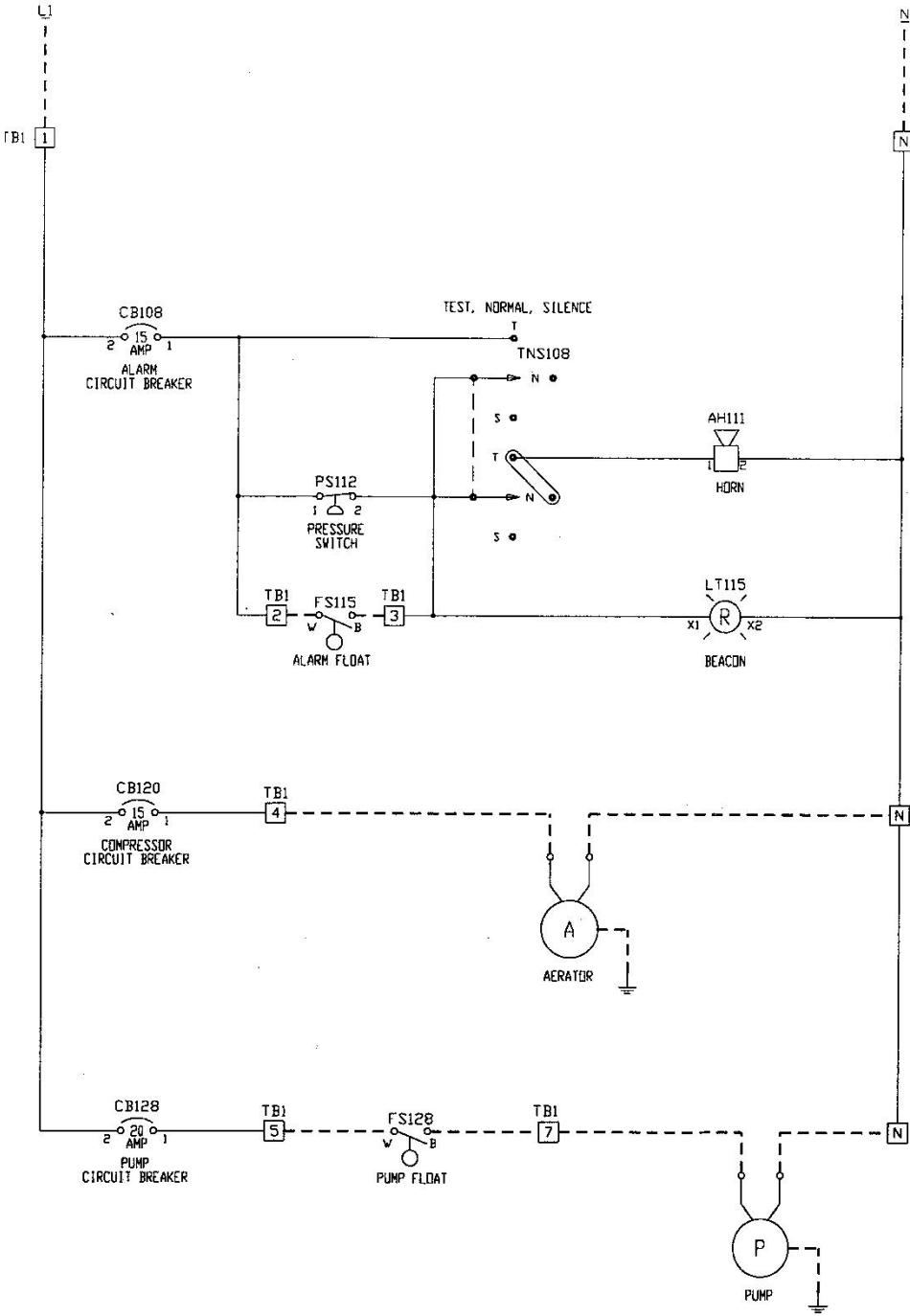



# I. Float Switch Information

The SJE Rhombus Signalmaster float switch is pre-mounted in Fuji Clean USA treatment systems. This information from SJE Rhombus is supplied for informed, proper handling during the installation process.

**SJE SIGNALMASTER®**



- Mechanically activated.
- Control differential of 1.5 inches above or below horizontal.
- Not sensitive to rotation.
- Mounting options: mounting clamp or cable weight.

**Note:** All hose clamp components are made of 18-8 stainless steel material. See your SJE-Rhombus® supplier for replacements.

**Figure A**

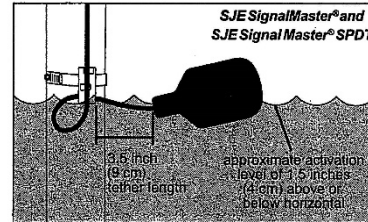

**⚠ WARNING**  
**ELECTRICAL SHOCK HAZARD**  
 Disconnect power before installing or servicing this product. A qualified service person must install and service this product according to applicable electrical and plumbing codes.



**⚠ WARNING**  
**EXPLOSION OR FIRE HAZARD**  
 Do not use this product with flammable liquids. Do not install in hazardous locations as defined by National Electric Code, ANSI/NFPA 70.

Failure to follow these precautions could result in serious injury or death. Replace product immediately if switch becomes damaged or severed. Keep these instructions with warranty after installation. This product must be installed in accordance with National Electric Code, ANSI/NFPA 70 so as to prevent moisture from entering or accumulating with in boxes, conduit bodies, fittings, float housing, or cable.

**PREVENTATIVE MAINTENANCE**

- Periodically check the product. Check that the cable has not become worn or that the housing has not been damaged so as to impair the protection of the product. Replace the product immediately if any damage is found or suspected.
- Periodically check to see that the float is free to move and operate the switch.
- Use only SJE Rhombus replacement parts.
- The Sensor Float and Sensor Float Mini control switches contain mercury and **MUST** be recycle or disposed of according to local, state and federal codes.

## **SJE-RHOMBUS® THREE-YEAR LIMITED WARRANTY**

**SJE-RHOMBUS®** warrants to the original consumer that this product shall be free of manufacturing defects for three years after the date of consumer purchase. During that time period and subject to the conditions set forth below, **SJE-RHOMBUS®** will repair or replace, for the original consumer, any component which proves to be defective due to defective materials or workmanship of **SJE-RHOMBUS®**.

**THIS EXPRESS WARRANTY DOES NOT APPLY TO THE MOTOR START KIT COMPONENT. SJE-RHOMBUS® MAKES NO WARRANTIES OF ANY TYPE WITH RESPECT TO THE MOTOR START KIT.**

**ELECTRICAL WIRING AND SERVICING OF THIS PRODUCT MUST BE PERFORMED BY A LICENSED ELECTRICIAN.**

**THIS WARRANTY DOES NOT APPLY:** (A) to damage due to lightning or conditions beyond the control of **SJE-RHOMBUS®**; (B) to defects or malfunctions resulting from failure to properly install, operate or maintain the unit in accordance with printed instructions provided; (C) to failures resulting from abuse, misuse, accident, or negligence; (D) to units which are not installed in accordance with applicable local codes, ordinances, or accepted trade practices, and (E) to units repaired and/ or modified without prior authorization from **SJE-RHOMBUS®**.

*Some states do not allow limitations on how long an implied warranty lasts, so the above limitation may not apply to you. Some states do not allow the exclusion or limitation of incidental or consequential damages, so the above limitation or exclusion may not apply to you. This warranty gives you specific legal rights, and you may also have other rights which vary from state to state.*

**TO OBTAIN WARRANTY SERVICE:** The consumer shall assume all responsibility and expense for removal, reinstallation, and freight. Any item to be repaired or replaced under this warranty must be returned to **SJE-RHOMBUS®**, or such place as designated by **SJE-RHOMBUS®**.

**ANY IMPLIED WARRANTIES OF MERCHANTABILITY OR FITNESS ARE LIMITED TO THE DURATION OF THIS WRITTEN WARRANTY. SJE-RHOMBUS® SHALL NOT, IN ANY MANNER, BE LIABLE FOR ANY INCIDENTAL OR CONSEQUENTIAL DAMAGES AS A RESULT OF A BREACH OF THIS WRITTEN WARRANTY OR ANY IMPLIED WARRANTY.**

## J. Start-Up Procedures

### 1. Outside Environment Check.

The system is accessible and nothing inhibits access to maintenance.

- Surface water is draining away from risers and covers.
- No signs of physical damage to the treatment system, piping, alarms or components
- No unusual smells around the system.
- No unusually loud blower noise, such as rattling.

### 2. Blower Box Check.

- Open the blower box, make sure that it is operating properly.
- Inspect all fittings and vents to ensure they are clean and dry and that blower is located so that it is protected from dust and particles, will remain dry and not be submerged.

### 3. Blower Operation and Blower Alarm Check.

- Make sure the blower operates properly.
- Turn off the blower (unplug or turn off at alarm/control panel breaker switch) for few moments to check that the alarm is triggered.

*Open all access covers and secure the area around the access openings.*

### 4. Water Level is at LWL.

- Check that tank has been filled to LWL mark in Chamber 1.



### 5. High Water Float Switch Check.

- Check that the high water float switch is operating freely. Lift up the high water float switch to check that the alarm is triggered.
- (Note: Float should have 3.5" tether. Activation horizon is 1.5" above or below level horizon).

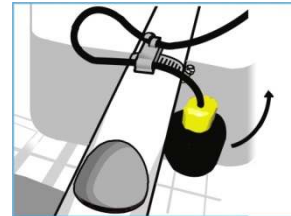

### 6. Set Recirculation Control Valve. (gray)

The recirculation valve (gray) should be set to its default setting range according to the table below for ALL flows. Make minor adjustment in valve setting based on recirculation flow level as described in the next step (Step 7).



Model	CE5	CE7	CE10
Default Valve Setting (%)	30% to 35%	25% to 30%	25% to 30%

**7. Check Recirculation Flow Rate.**

- Recirculation flow should be level with the top edge of the airlift pumpback line cut-out spilling into Chamber 1, the Sedimentation Chamber. Using the recirculation valve, make minor adjustments if necessary to attain this flow level.



**8. Check/Set Aeration Balance Control Valve (blue).**

- The default, normal setting for the Aeration Control Valve is 50%.
- Visually observe the airflow rates on each side of the plant by checking to see if bubbles are evenly distributed on both sides of Chamber 3, The Aeration Chamber. If there is an obvious discrepancy in airflow between the two sides, adjust the Aeration Balance Control Valve so that the airflow is equal. Important!



- 9. Check/Set Effluent Airlift Valve (white).** The Effluent Control Valve is initially set to 40% and there is typically no need for it to be adjusted under standard conditions.

**10. Check Effluent Airlift Pipe.**

Check the observation port in the airlift line to see if there is smooth water flow from the effluent airlift pump. If not, then check to be sure that there isn't a clog in the airlift pipe with a cleaning brush.



**11. Remove Chlorinator**

- Indiana does not allow chlorination so the chlorinator vessel may be removed and discarded.

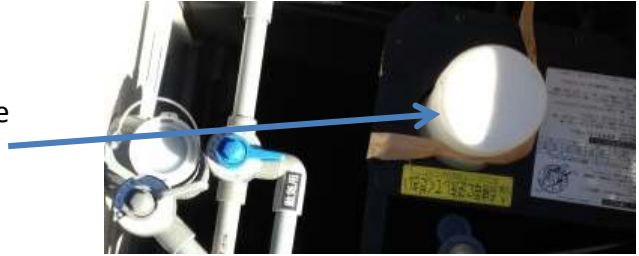

**12. Check Alarm/Control Panel**

- Check to be sure that Alarm/Control Panel is located in a secure, accessible location.
- Check fittings and wire connections are tight and secure. This includes connection between air hose and pressure switch.
- Important: Check to be sure that all panel penetrations are air and watertight. Be sure no gas from treatment system can leak into Alarm/Controller.
- Be sure electrical cord between blower and outlet is free and clear and no object is on cord.
- Check to be sure that panel is closed, secure and toggle switch is set to "Normal" setting.

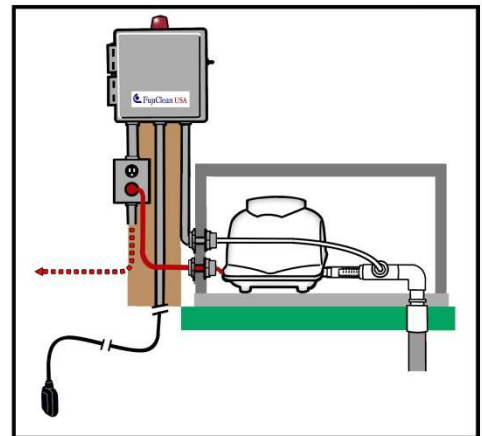

**13. Final Site Preparation**

- Close and secure all access covers.
- Close and secure blower cover.

**14. Owner Communication**

- Be sure that home/business owner has a copy of the Fuji Clean USA Owner's Manual (with Warranty information included).
- Be sure that service provider contact information is affixed to Alarm/Control Panel as well as on Homeowner's Manual.



Intelligently Engineered Treatment Systems for Domestic Wastewater

Service Provider:	Name:	Model:
Name:	Company:	CE5    CE7    CE18
Address:	Telephone:	CE6    CE7    CE19
Email:	Blower Serial #:	

# TROUBLESHOOTING

## Air Blower

**What to observe**

**Status**

**How to solve the problem**

### Blower is not working

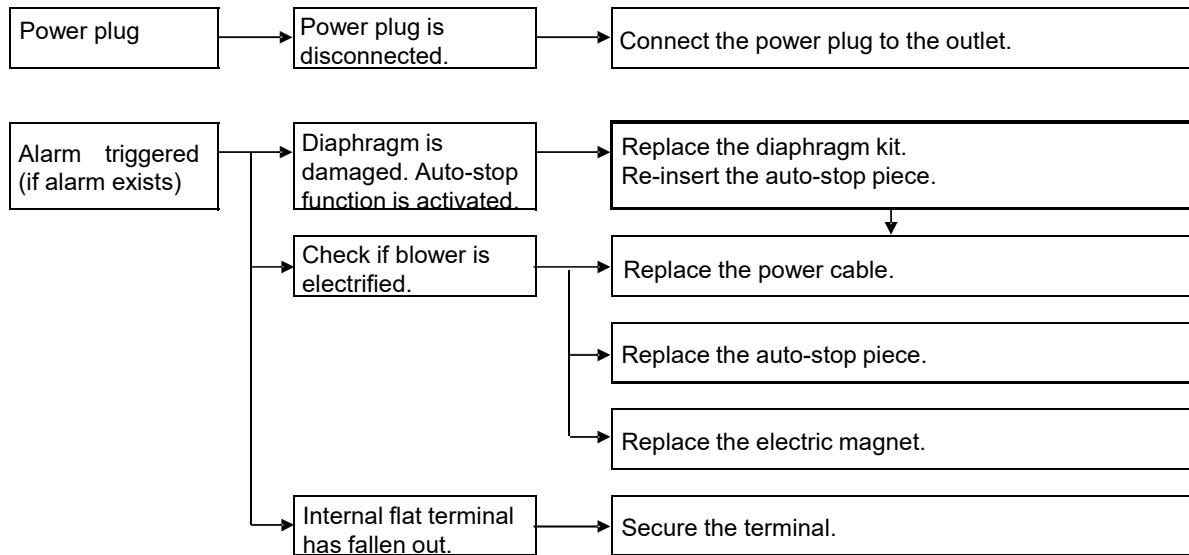

### Blower is making an abnormal or excessive operating noise.

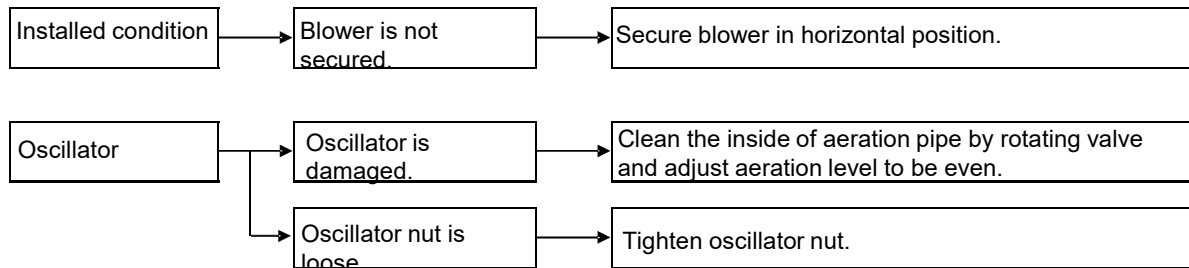

### Low air volume or misplaced air from aeration pipes (treatment plant)

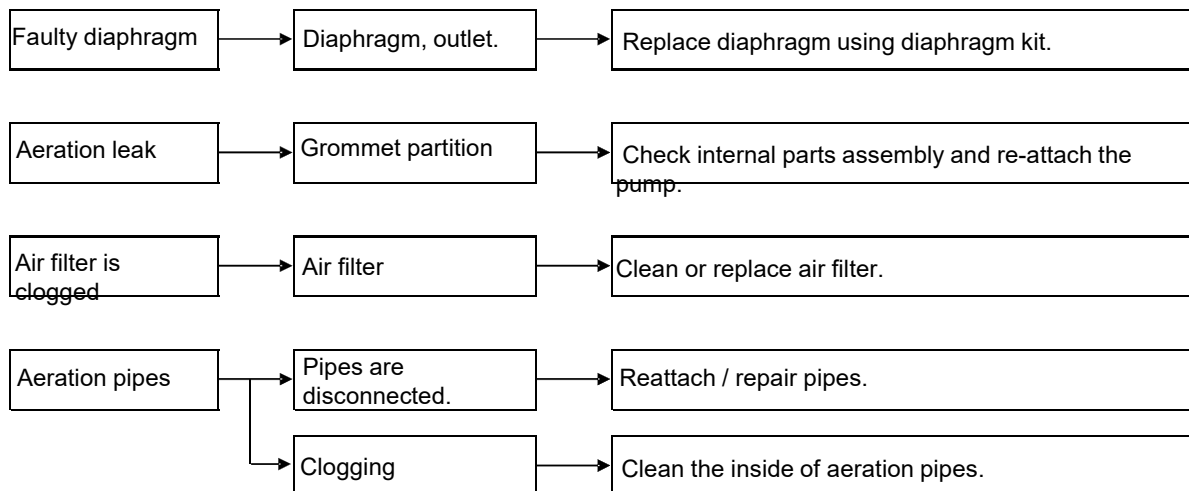



## **Fuji Clean USA Installation Procedure Checklist**

**Note:** Please consult Installation Manual for detailed instructions.

### **Unloading Instructions:**

- Upon delivery, inspect Fuji Clean tank, both outside and inside for possible damage incurred during transport. If you find damage, or have a question, please contact your distributor immediately.
- Step 1: Prepare excavation to be at least 1 to 2 feet larger than the Fuji Clean tank dimensions. Note: Riser height shall not exceed 24".**
- Step 2: Prepare 4"- 6" bed of stone (¼" to ½"), level to within 1/8".**
- Step 3: Use 4-point lifting lugs. Carefully lower and set tank. Level to within 1/8-inch.**
- Step 4: If any part of the tank is below the estimated seasonal high water table, adequate tank uplift restraint measures should be taken. Please refer to Installation Manual for recommended options.**
- Step 5: Re-check that tank is level to 1/8-inch, (fore and aft as well as side to side) and then fill tank with fresh water to the low water line (marked inside tank). Start 24-hour water tightness test. (Please contact your distributor or Fuji Clean USA if water level has dropped after 24 hours).**
- Step 6: Backfill about ¾ way up tank in layered, compacted 6" lifts using peastone or equivalent material that form-fits into tank corrugations.**
- Step 7: Using supplied adaptors and fittings, attach air pipe fitting to tank and connect to ¾" conduit in prepared trench (min. 6" deep) to location of air blower. Please note: flexible tubing, 100 PSI Max, may also be used for the airline.**
- Step 8: Locate blower within 100-ft. of treatment tank with no more than 5 elbows. If site conditions prevent this configuration, please contact your distributor or Fuji Clean USA for technical assistance.**

#### **Air Blower shall be:**

- ✓ as close to the control panel as possible
- ✓ on a solid (e.g. concrete) pad to minimize vibrations
- ✓ in a flood-proof location (blower cannot be submerged)
- ✓ away from grease exhaust fans.
- ✓ away from bedroom windows and other locations where operational sounds (although minimal) may be a nuisance
- ✓ In a location that allows unencumbered access for inspection and maintenance activity
- ✓ with proper electrical grounding
- ✓ with wiring and electrical connections made - all adhering to applicable electrical code
- ✓ with no objects on top of electrical cord.
- ✓ in a well-ventilated space out of direct sunlight and protected from elements such as direct rain or snowfall.

## Fuji Clean USA Installation Procedure Checklist cont.

### Alarm Panel shall be:

- ✓ in a well ventilated area as dry and protected from elements as possible
- ✓ in as close of proximity to **MACBlower** as possible
- ✓ wired by licensed electrician, if required, or electrician qualified by Fuji Clean if no license is required
- ✓ in a location that allows unencumbered access for inspection and maintenance activity

- Step 9:** Install insulated risers and covers and cover upper half of treatment unit with min. R-8 value insulating material (i.e. foam board)
- Step 10:** Float switch electrical cord should exit riser wall through a male adaptor (caulked watertight to prevent septic gas leakage) or watertight fitting.
- Step 11:** Prepare Tank Inlet and Outlet for 4" Sch 40 PVC (ASTM D2466) Inlet and Outlet Lines (secure with PVC cement).
- Step 12:** In nearly all cases, the Fuji Clean system will vent through the house septic influent line. In cases where there is an influent pump, or in severe downdraft locations, a separate vent should be considered. If a separate vent is installed, be sure that the vent slopes toward the tank so that any moisture accumulation drips back down toward the tank.
- Step 13:** During final landscaping, seeding etc., be sure to pitch final grade away from covers to sweep surface water away from treatment tank.
- Step 15:** Finalize Controller Wiring. Please refer to wiring diagram (in Installer Manual and enclosed separately in alarm/control panel). Upgraded Fuji Clean USA controllers are available if telecommunications, elapsed time meter or other functions are required. Please contact Fuji Clean USA for details.
- Step 16:** Follow start-up procedure detailed in Installation Manual:
  - 1. Outside Environment Check.
  - 2. Blower Box Check.
  - 3. Blower Operation and Blower Alarm Check
  - 4. Water Level is at LWL.
  - 5. High Water Float Switch Check.
  - 6. Set Recirculation Control Valve. (gray)
  - 7. Check Recirculation Flow Rate.
  - 8. Check/Set Aeration Balance Control Valve (blue).
  - 9. Check/Set Effluent Airlift Valve (white).
  - 10. Check Effluent Airlift Pipe.
  - 11. Remove Chlorinator
  - 12. Check Alarm/Control Panel
  - 13. Final Site Preparation
  - 14. Owner Communication - Service Provider and Manual Delivery



## H. Indiana Authorized Providers

### 1. Authorized Indiana Service Providers (to date):

- a. Tim Shopp,  
TJ Misc., Inc.  
2989 County Road 43, Waterloo, IN 46793  
Tel: 260-868-1043 (office); 260-417-1786 (mobile)

### 2. Authorized Indiana Installers (to date)

- a. Tim Shopp,  
TJ Misc., Inc.  
2989 County Road 43, Waterloo, IN 46793  
Tel: 260-868-1043 (office); 260-417-1786 (mobile)

### 3. Design and Installation Training

Installation training and certification will be provided by TJ Misc.. Inc. to designers, installers and those involved in permitting onsite systems. Training and certification is required prior to installation. TJ Misc. will provide certification and evidence of training and a copy of that certification and evidence will be maintained by TJ Misc. and will be provided to ISDH. TJ Misc. will directly supervise the first system installation for each installer to ensure that designs / installation instructions are being followed.

### 4. Operation and Maintenance Training:

Operation and Maintenance training and certification will be provided by TJ Misc. Inc. TJ Misc. will provide evidence of training and a copy of that evidence will be maintained by TJ Misc. Inc. and will be provided to ISDH. All authorized service providers shall follow provisions outlined in the Fuji Clean USA Indiana TNI Approval and Local Health Department requirements.

### 5. Notification:

ISDH shall be notified at least 10 working days in advance of any scheduled training events.

### 6. Additional Providers:

Fuji Clean USA, LLC, is committed to providing additional service providers as market demands increase.