

Indiana Department of Transportation







CERTIFIED TECHNICIAN PROGRAM TRAINING MANUAL FOR **Bridge Construction and Deck Repair**

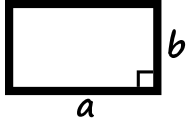
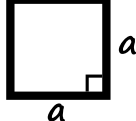

2024 Revision

MATH REFERENCES

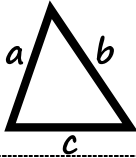
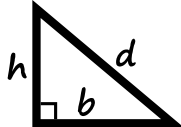
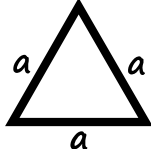
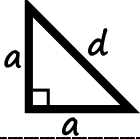
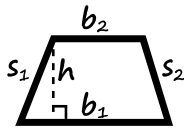
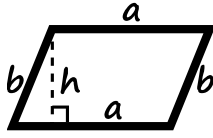
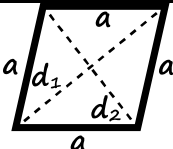
1 foot = 12 inches 1 square foot = 144 square inches 1 cubic foot = 1728 cubic inches
 3 feet = 1 yard 9 square feet = 1 square yard 27 cubic feet = 1 cubic yard
 5280 feet = Mile 1760 yards = 1 mile 1 acre = 4840 square yards

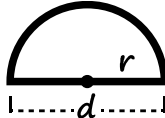
Rectangle		Square	
Perimeter	$2(a + b)$	Perimeter	$4a$
Area	$a \times b$	Area	a^2
Triangle		Triangle (any)	
Perimeter	$a + b + c$	Area by sides (no height)	$s = \frac{1}{2}(a + b + c)$
Area	$\frac{1}{2}(b \times h)$		$A = \sqrt{s(s - a)(s - b)(s - c)}$
Right Triangle		Equilateral Triangle	
Perimeter	$b + h + d$	Perimeter	$3a$
Area	$\frac{1}{2}(b \times h)$	Area	$\frac{\sqrt{3}}{4}a^2$
Isosceles Right Triangle		Trapezoid	
Perimeter	$2a + d$	Perimeter	$b_1 + b_2 + s_1 + s_2$
Area	$\frac{1}{2}a^2$	Area	$h \times \frac{b_1 + b_2}{2}$
Parallelogram		Rhombus	
Perimeter	$2(a + b)$	Perimeter	$4a$
Area	$a \times h$	Area	$\frac{d_1 \times d_2}{2}$
Circle		Semicircle	
Perimeter	$2\pi r$	Perimeter	$\pi r + 2r$
Area	πr^2	Area	$\frac{\pi r^2}{2}$

AREA OF A CIRCULAR SEGMENT

$$\text{Area} = C \times b \times \text{coefficient}$$

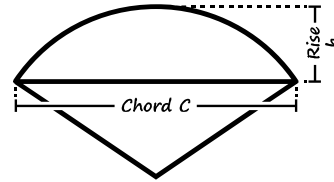

Coefficient	$\frac{b}{C}$
0.66667	0.00218
0.66668	0.00436
0.66669	0.00655
0.66671	0.00873
0.66673	0.01091
0.66676	0.01309
0.66679	0.01528
0.66683	0.01746
0.66687	0.01965
0.66692	0.02183
0.66697	0.02402
0.66703	0.02620
0.66710	0.02839
0.66717	0.03058
0.66724	0.03277
0.66732	0.03496
0.66740	0.03716
0.66749	0.03935
0.66759	0.04155
0.66769	0.04374
0.66779	0.04594
0.66790	0.04814
0.66802	0.05035
0.66814	0.05255
0.66826	0.05476
0.66839	0.05697
0.66853	0.05918
0.66867	0.06139
0.66882	0.06361
0.66897	0.06583
0.66913	0.06805
0.66929	0.07027
0.66946	0.07250
0.66964	0.07473
0.66981	0.07696
0.67000	0.07919
0.67019	0.08143
0.67039	0.08367
0.67059	0.08592
0.67079	0.08816
0.67101	0.09041
0.67122	0.09267
0.67145	0.09493
0.67168	0.09719
0.67191	0.09946

Coefficient	$\frac{b}{C}$
0.67215	0.10173
0.67240	0.10400
0.67265	0.10628
0.67291	0.10856
0.67317	0.11085
0.67344	0.11314
0.67372	0.11543
0.67400	0.11773
0.67429	0.12004
0.67458	0.12235
0.67488	0.12466
0.67519	0.12698
0.67550	0.12931
0.67582	0.13164
0.67614	0.13397
0.67647	0.13632
0.67681	0.13866
0.67715	0.14101
0.67750	0.14337
0.67786	0.14574
0.67822	0.14811
0.67859	0.15048
0.67897	0.15287
0.67935	0.15525
0.67974	0.15765
0.68014	0.16005
0.68054	0.16246
0.68095	0.16488
0.68136	0.16730
0.68179	0.16973
0.68222	0.17216
0.68265	0.17461
0.68310	0.17706
0.68355	0.17952
0.68401	0.18199
0.68448	0.18446
0.68495	0.18694
0.68543	0.18943
0.68592	0.19193
0.68642	0.19444
0.68692	0.19696
0.68743	0.19948
0.68795	0.20201
0.68848	0.20456
0.68901	0.20711

Coefficient	$\frac{b}{C}$
0.68956	0.20967
0.69011	0.21224
0.69067	0.21482
0.69123	0.21741
0.69181	0.22001
0.69239	0.22261
0.69299	0.22523
0.69359	0.22786
0.69420	0.23050
0.69482	0.23315
0.69545	0.23582
0.69608	0.23849
0.69673	0.24117
0.69738	0.24387
0.69805	0.24657
0.69872	0.24929
0.69941	0.25202
0.70010	0.25476
0.70080	0.25752
0.70151	0.26028
0.70223	0.26306
0.70297	0.26585
0.70371	0.26866
0.70446	0.27148
0.70522	0.27431
0.70600	0.27715
0.70678	0.28001
0.70758	0.28289
0.70838	0.28577
0.70920	0.28868
0.71003	0.29159
0.71087	0.29452
0.71172	0.29747
0.71258	0.30043
0.71345	0.30341
0.71434	0.30640
0.71524	0.30941
0.71615	0.31243
0.71707	0.31548
0.71800	0.31854
0.71895	0.32161
0.71991	0.32470
0.72088	0.32781
0.72187	0.33094
0.72287	0.33409

Coefficient	$\frac{b}{C}$
0.72388	0.33725
0.72491	0.34044
0.72595	0.34364
0.72701	0.34686
0.72808	0.35010
0.72916	0.35337
0.73026	0.35665
0.73137	0.35995
0.73250	0.36327
0.73364	0.36662
0.73480	0.36998
0.73598	0.37337
0.73717	0.37678
0.73838	0.38021
0.73960	0.38366
0.74084	0.38714
0.74210	0.39064
0.74337	0.39417
0.74466	0.39772
0.74597	0.40129
0.74730	0.40489
0.74865	0.40852
0.75001	0.41217
0.75140	0.41585
0.75280	0.41955
0.75422	0.42328
0.75566	0.42704
0.75713	0.43083
0.75861	0.43464
0.76011	0.43849
0.76164	0.44236
0.76318	0.44627
0.76475	0.45020
0.76634	0.45417
0.76795	0.45817
0.76959	0.46220
0.77125	0.46626
0.77293	0.47035
0.77463	0.47448
0.77636	0.47865
0.77812	0.48284
0.77990	0.48708
0.78171	0.49135
0.78354	0.49566
0.78540	0.50000

MANUAL DISCLAIMER

The references in this manual are reflective of the 2022 INDOT Standard Specifications. The material covered herein is for training purposes only. The Standard Specifications, Contract Information Book, General Instruction to Field Employees, and Construction Memos should be consulted for determining the current inspection procedures for a given contract. On-site procedures, field tests, and other operating procedures may vary from those described within this manual.

TABLE OF CONTENTS

CHAPTER ONE: BRIDGE CONSTRUCTION OVERVIEW	1-1
TECHNICIAN DUTIES	1-1
BASIC BRIDGE TERMS	1-1
Substructure.....	1-1
Superstructure	1-2
Spans And Span Length.....	1-3
Simple And Continuous Spans.....	1-4
BRIDGE PLANS.....	1-4
Title And Index Sheet	1-4
Boring Data Sheets	1-4
Layout Sheet	1-4
General Plan Sheet.....	1-5
Detail Plan Sheets	1-5
Standard Drawings.....	1-5
Bridge Summary And Estimate Of Quantities Sheets	1-5
Contractor Plans Or Drawings	1-6
CONSTRUCTION CONTROLS AND LAYOUT	1-6
Horizontal Controls	1-6
Vertical Controls.....	1-6
Bridge Construction Layout.....	1-7
CHAPTER TWO: FOUNDATIONS.....	2-1
STRUCTURE EXCAVATION	2-1
Soil Borings.....	2-1
Cross Sections.....	2-2
Classes Of Structure Excavation.....	2-2
Limits of Excavation	2-3
Disposal of Excavated Material	2-3
Preparation of Foundation Surfaces	2-4
Subsoil Investigations.....	2-5
Dewatering Excavations	2-5
Cofferdam Construction.....	2-5

FOUNDATION PILING	2-6
<i>Types Of Piling</i>	2-7
<i>Delivery And Acceptance</i>	2-7
<i>Pile Driving Hammers</i>	2-7
<i>Energy Output</i>	2-9
<i>Bearing and Refusal</i>	2-9
<i>Test Piling</i>	2-10
<i>Driving Foundation Piles</i>	2-11
<i>Measurement and Payment</i>	2-14
CHAPTER THREE: FORMS, FALSEWORK, AND REINFORCEMENT	3-1
FORMS.....	3-1
<i>Basic Form Requirements</i>	3-1
<i>Form Plans</i>	3-1
<i>Form Materials</i>	3-2
<i>Form Construction</i>	3-3
<i>Installation of Form Ties and Spreaders</i>	3-3
<i>Chamfer Strips</i>	3-4
<i>Keyways</i>	3-4
<i>Preparation For Concrete Placement</i>	3-4
<i>Removal Of Forms</i>	3-4
FALSEWORK	3-5
<i>Reinforcement</i>	3-6
<i>Reinforcement Details</i>	3-8
<i>Delivery And Storage</i>	3-8
<i>Installation of Reinforcement</i>	3-9
<i>Method of Measurement</i>	3-11
<i>Basis of Payment</i>	3-11
CHAPTER FOUR: CONCRETE PLACEMENT	4-1
CLASSES OF STRUCTURAL CONCRETE	4-1
CONCRETE PLANT INSPECTION	4-1
<i>Types of Plants</i>	4-1
<i>Preparations for Concrete Placement</i>	4-1
<i>Plan Review</i>	4-2
<i>Site Preparations</i>	4-2
<i>Weather Restrictions</i>	4-2
CONCRETE DELIVERY	4-3
<i>Delivery Equipment</i>	4-3
<i>Delivery Tickets</i>	4-3
FIELD TESTS	4-4
<i>Recording Test Results</i>	4-5
CONCRETE PLACEMENT	4-5
<i>Segregation</i>	4-5
<i>Consolidation Of Concrete</i>	4-6

<i>Construction Joints</i>	4-7
<i>Special Cases</i>	4-7
FINISHING CONCRETE SURFACES.....	4-8
<i>Finishing Bearing Areas</i>	4-8
<i>Other Surface Treatments</i>	4-8
<i>Curing Substructure Concrete</i>	4-8
<i>Cold Weather Curing</i>	4-9
METHOD OF MEASUREMENT AND BASIS OF PAYMENT.....	4-9
CHAPTER FIVE: BEARINGS AND STRUCTURAL MEMBERS.....	5-1
BEARINGS.....	5-1
<i>Expansion, Semi-Fixed, and Fixed</i>	5-1
<i>Bearing Design</i>	5-1
<i>Elastomeric Bearings</i>	5-3
<i>Steel Bearings</i>	5-3
<i>Bearing Installation And Adjustments</i>	5-4
STRUCTURAL STEEL.....	5-5
<i>Beams and Girders</i>	5-5
<i>Approval of Structural Steel</i>	5-7
<i>Structural Steel Plans</i>	5-7
<i>Delivery and Storage</i>	5-8
<i>Erection of Steel Members</i>	5-9
<i>Field Welding</i>	5-12
<i>Measurement and Payment</i>	5-13
CONCRETE MEMBERS.....	5-13
<i>Delivery, Storage, and Handling</i>	5-13
<i>Erecting Concrete Beams</i>	5-14
<i>Final Approval of Concrete Members</i>	5-15
<i>Measurement and Payment</i>	5-15
CHAPTER SIX: BRIDGE DECKS.....	6-1
REFERENCES.....	6-1
GRADE CONTROL.....	6-1
<i>Screed Elevations</i>	6-1
DECK FORMS.....	6-2
<i>Approval of Falsework Plans</i>	6-2
<i>Types of Deck Forms</i>	6-2
<i>Installing Deck Forms</i>	6-3
INSTALLATION OF SHEAR CONNECTORS.....	6-4
DECK REINFORCEMENT.....	6-4
ADJUSTING THE SCREED RAILS.....	6-5
CONCRETE PLACEMENT.....	6-6
<i>Pre-Pour Conference</i>	6-6
<i>Preparation of the Forms</i>	6-7

Concrete Placement and Consolidation	6-7
Finishing Operations	6-8
Curing Requirements	6-8
QC/QA SUPERSTRUCTURE CONCRETE	6-9
CHAPTER SEVEN: BRIDGE DECK REPAIR.....	7-1
PREPARATIONS FOR DECK REPAIR.....	7-1
HMA Widening	7-1
Traffic Control	7-2
SURFACE MILLING (OR SCARIFICATION)	7-3
Purpose	7-3
Equipment.....	7-4
Procedures.....	7-4
Measurement and Payment.....	7-5
LOCATING DETERIORATED AREAS OF DECK.....	7-5
Visual Inspection	7-5
Sounding.....	7-5
Procedures For Marking.....	7-6
REMOVING DETERIORATED AREAS OF DECK	7-6
Hand-chipping.....	7-6
Hydrodemolition	7-7
REINFORCING BARS.....	7-7
PARTIAL-DEPTH AND FULL-DEPTH PATCHES.....	7-8
Resounding, Re-Inspecting, and Additional Removal	7-8
Cleaning	7-9
Measuring.....	7-9
Patching Procedure Using Bridge Floor Slab Patching Concrete.....	7-10
EXPANSION JOINTS AND ROADWAY DRAINS	7-10
SS Joints (Expansion Joint SS).....	7-10
Modular Joints (Expansion Joint M).....	7-10
MATERIALS.....	7-11
Aggregates.....	7-11
Portland Cement.....	7-11
Latex Modifiers	7-11
Fly Ash.....	7-12
CALIBRATION	7-12
Equipment.....	7-12
Pre-Calibration Inspection.....	7-12
Initial Calibration.....	7-12
PREPARATIONS AND FINAL INSPECTIONS PRIOR TO PLACING OVERLAY.....	7-14
Blasting and Cleaning	7-14
Finishing Machine Set-Up	7-14
Final Inspections of the Deck.....	7-14
OVERLAY PLACEMENT	7-15

Limitations7-15
Bond Coat7-15
Finishing7-15
Curing..... 7-16
Texturing..... 7-16
POST-CURE INSPECTIONS, MEASUREMENT, AND PAYMENT 7-17
Inspecting for Cracks.....7-17
Sounding for Bond7-17
Method of Measurement.....7-17
Basis of Payment.....7-17
PATCHING EXISTING OVERLAY..... 7-17

CHAPTER ONE: *BRIDGE CONSTRUCTION*

OVERVIEW

TECHNICIAN DUTIES

The general duties of a Bridge Technician are essentially the same as for all other Technicians. These duties are defined in Section 105.09 and are summarized here for easy reference.

Bridge Technicians employed by INDOT are assigned to a contract to:

1. Keep the Project Engineer or Project Supervisor (PEMS) informed of the progress of the work and the way the work is being done.
2. Report whenever the materials furnished, or the work conducted, fails to fulfill the requirements of the Specifications and the contract.
3. Call to the attention of the Contractor any known deviation from, or infringement upon, the plans and Specifications with respect to materials and workmanship as they occur.

Technicians are required to keep informed concerning the Contractor's planned work for each day, including the location of the work, the work to be done, how much is done, and what equipment is used. The Technician is expected to complete the required daily reports and submit them promptly to the PEMS.

Technicians are authorized to inspect all work conducted and materials furnished by the Contractor. The Technician has the authority to reject defective materials and to suspend any work that is being done improperly subject to the final decision of the PEMS. Technicians may not change any requirement of the plans or Specifications, nor are they allowed to conduct other duties for the Contractor.

BASIC BRIDGE TERMS

An important first step in understanding the principles and processes of bridge construction is learning basic bridge terminology. Although bridges vary widely in material and design, there are many components that are common to all bridges. In general, these components may be classified either as parts of a bridge substructure or as parts of a bridge superstructure.

SUBSTRUCTURE

The substructure consists of all the parts that support the superstructure. The main components are abutments or end-bents, piers or interior bents, footings, and piling.

Abutments support the ends of the bridge and confine the approach embankment, allowing the embankment to be built up to grade with the planned bridge deck. Integral end bents (abutments) are becoming more common. Typical abutment designs are illustrated in Figure 1-1.

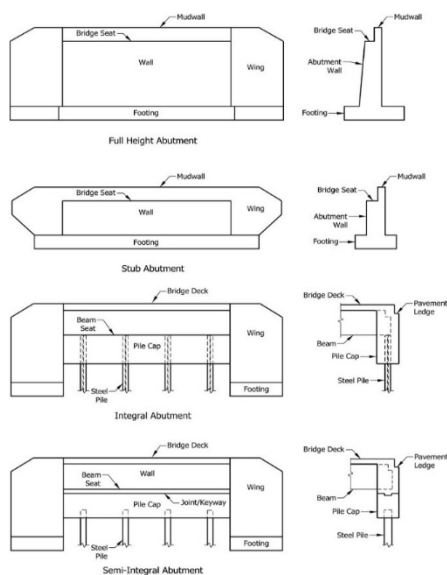

Figure 1-1 Abutments

When a bridge is too long to be supported by abutments alone, piers or interior bents are built to provide intermediate support. Although the terms may be used interchangeably, a pier generally is built as a solid wall, while a bent is usually built with columns. Figure 1-2 illustrates several types of bents and piers.

The top part of abutments, piers, and bents is called the cap. The structural members rest on raised, pedestal-like areas on top of the cap called bridge seats. The part of abutments and bents between the ends of the structural members and the approach embankment is called the mudwall. The devices that are used to connect the structural members to the bridge seats are called shoes or bearings.

Abutments, bents, and piers are sometimes built on spread footings. Spread footings are large blocks of reinforced concrete that provide a solid base for the substructure and anchor the substructure against lateral movements. Footings also serve to transmit loads borne by the substructure to the underlying foundation material.

When the soils beneath a footing are not capable of supporting the weight of the structure above the soil, bearing failure occurs. The foundation shifts or sinks under the load, causing structure movement and damage (Figure 1-3).

In areas where bearing failure or other soil failure is likely, footings are built on foundation piling (Figure 1-4). Piles are load-bearing members that are driven deep into the ground at footing locations to stabilize the footing foundation. Piling transmits loads from the substructure units down to underlying layers of soil or rock.

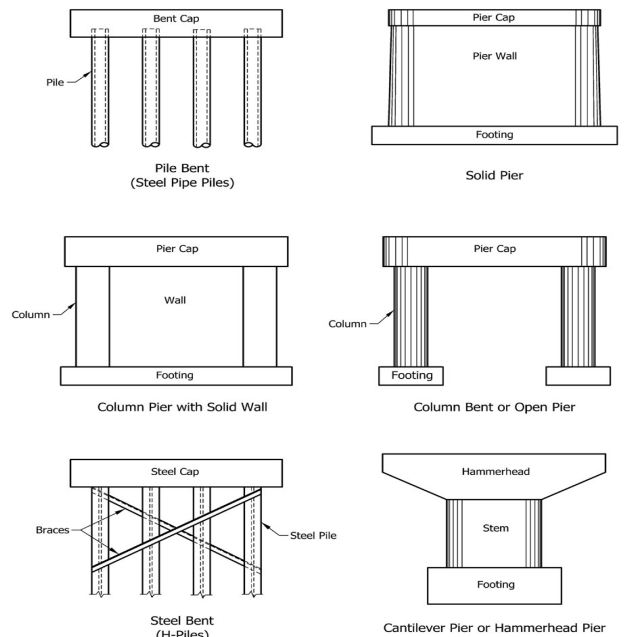

Figure 1-2 Piers

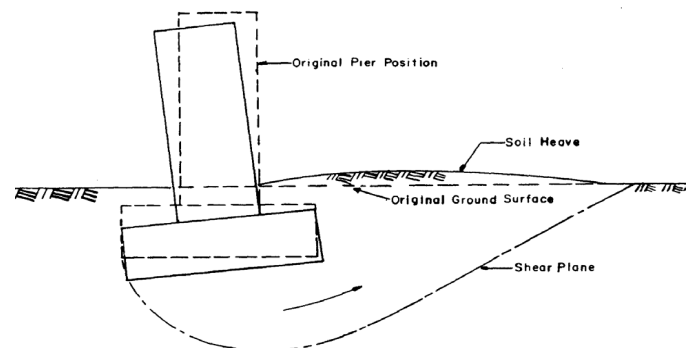

Figure 1-3 Bearing Failure

SUPERSTRUCTURE

The bridge superstructure consists of the components that span the obstacle the bridge crosses and includes the following:

1. Bridge floor slab
2. Structural members
3. Bridge railings (known as *parapets*), handrails, sidewalk, lighting, and some drainage features

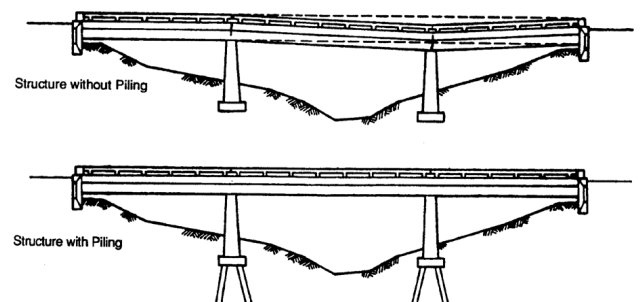

Figure 1-4 Structure Piling

A bridge floor is the entire length of the bridge from the roadway side of the mudwall or pile cap to the other roadway side of the mudwall or pile cap and the entire width from one coping

edge across to the other coping edge. The bridge deck is the roadway portion of a bridge, including shoulders. Most bridge floor slabs are constructed as reinforced concrete slabs, but timber decks are occasionally used in rural areas and open-grid steel decks are used in some movable bridge designs such as a bascule bridge. As polymers and fiber technologies improve, Fiber Reinforced Polymer, or *FRP* decks, may be used. Although technically not the same thing, the terms bridge floor slab and bridge deck are often used interchangeably.

Bridge decks must match the grade of the approach roadway so that there is no bump or dip as a vehicle travels onto or off the bridge.

The most common causes of premature bridge deck failure are:

1. Improper amounts of air entraining admixtures, improper curing, a high water/cementitious ratio, segregation of the concrete, or insufficient concrete strength from an improper concrete mix design
2. Improper concrete placement, such as failure to consolidate the mix as the concrete is placed, pouring the concrete too slowly such that the concrete begins its initial set prior to completing the pour, or not maintaining a placement rate in accordance with the approved pour rate as per Section **704.04**
3. Insufficient concrete cover due to improper screed settings or incorrect installation of the deck forms and/or reinforcement

Consequently, it is the intent of INDOT and therefore the Technician, to pay attention to the items listed above to allow bridge structures to attain the longevity they are designed for.

A bridge deck is generally supported by structural members. The most common types are:

1. Steel I-beams and girders
2. Precast, prestressed, reinforced concrete bulb T-beams
3. Precast, prestressed, reinforced concrete I-beams
4. Precast, prestressed, concrete box beams
5. Reinforced concrete slabs

Secondary members, called diaphragms, are used as cross-braces between the main structural members and are also part of the superstructure.

Bridge railings, or *parapets*, handrails, sidewalks, lighting, and drainage features have little to do with the structural strength of a bridge but are important for aesthetics and safety. The materials and workmanship that go into the construction of these features require the same level of inspection effort as any other phase of the work.

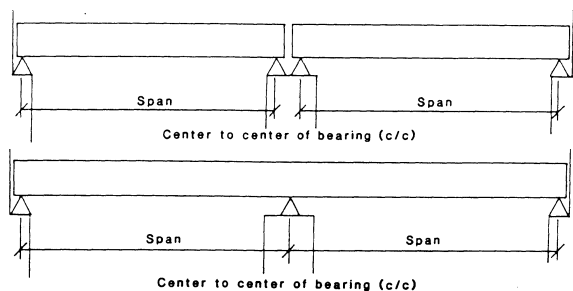

Figure 1-5 Bridge Spans

SPANS AND SPAN LENGTH

The terms *bridge* and *span* are often used interchangeably. To avoid confusion and misunderstanding, construction personnel distinguish the two as follows: a bridge is made up of one or more spans, and a span is a segment of a bridge that crosses from one substructure unit to the next (i.e., from abutment to abutment, abutment to pier, pier to pier, etc.).

Span length refers to either the length of an individual span within the structure or the total bridge length. In most cases, span length is considered as the distance between the centerlines of bearing from one substructure unit to the next (Figure 1-5).

SIMPLE AND CONTINUOUS SPANS

In addition to the basic bridge design (which includes girder, arch, truss, suspension, etc.), a bridge may be further classified as *simple* or *continuous span* (Figure 1-6). Both simple and continuous spans may exist in the same bridge. Which classification is used depends on the arrangement of structural members.

A span with structural members that cross from one substructure unit to the next substructure unit is a simple span. The simple span has fixed bearings on one end and expansion bearings on the other end. Any bridge that is supported by abutments alone is a simple span. An individual span within a bridge that extends from an abutment to a pier or a pier to another pier is also a simple span. Occasionally bridges are constructed as a series of simple spans, although these are not common in Indiana.

A continuous span is a bridge or bridge segment with structural members that cross over one or more substructure units without a break. The structural members may have to be spliced to obtain the necessary length. Spliced structural members are still considered one-piece members. Continuous spans are typically anchored to the substructure by expansion bearings and a single fixed bearing.

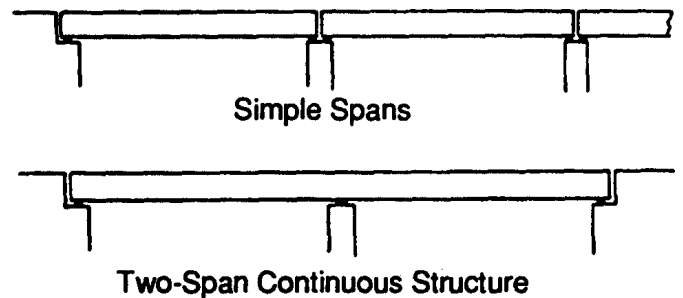

Figure 1-6 Simple and Continuous Spans

BRIDGE PLANS

Bridge plans are generally attached as supplements to the roadway construction plans. Although from time to time there will be stand-alone bridge projects. The basic types of sheets in a set of bridge plans include the following.

TITLE AND INDEX SHEET

The title and index sheet identifies the bridge by contract number, unique structure number, and location, and contains an index of all other sheets in the plans.

BORING DATA SHEETS

The boring data sheets indicate the results of soil borings made at the bridge site prior to construction. The Technician uses these sheets to identify the types of soils that are encountered during structure excavation, and to determine the approximate depths at which the types of soils are found.

LAYOUT SHEET

The layout sheet consists primarily of a topographical *situation plan* of the bridge site and a profile view of the proposed bridge grade. The situation plan identifies the landowners and natural and manmade features in the contract area. The plan also delineates right of way limits, limits of construction, and the locations of benchmarks for grade control. The layout sheet also includes a list of utilities in the contract area that may be affected by the contract.

GENERAL PLAN SHEET

The General Plan sheet includes a plan view, which is the bridge seen from above, and an elevation view, which is the bridge seen from the side.

The plan view identifies:

1. The exact location of the bridge in terms of the contract station numbers and the obstacle the bridge is intended to cross
2. The degree of skew of the bridge
3. Any and all critical centerlines for the structure, roadway, and bearings
4. The overall length of the bridge and the lengths of all individual spans
5. All significant widths for the *out-to-outs*, roadways, shoulders, sidewalks, and bridge railings/parapets

The elevation view identifies:

1. Original and projected ground lines
2. Elevations of railroads, low water, high water, highways, etc., to be crossed and any minimum vertical clearance requirements
3. Minimum tip elevation for piling and the planned bottom-of-footing elevations
4. The locations of fixed and expansion bearings

The General Notes section of the plans may be included on the General Plan sheet or may be found on a separate sheet. Much of the information found in the General Notes is common information that is essentially the same on all similar bridge contracts. There may also be additional information that is contract specific in this section.

DETAIL PLAN SHEETS

Detail plan sheets provide details not included in the general plan and elevation views. Typically, detail plan sheets are provided for each unit of the substructure, the framing plan (superstructure details), and the floor details that describe how the bridge deck is to be built.

In many cases, identical or very similar bridge features are described on the same detail sheet. For example, plans for a bridge with two nearly identical piers may include one detail sheet for both piers. Any significant difference between the two piers would be noted in the plans. Detail sheets also include a bill of materials section. The bill of materials lists the types and quantities of the materials that are required to construct that part of the bridge according to the plans. The materials listed are primarily concrete and reinforcing bars, though other items such as bearing pads, surface seal, expansion joints, and roadway drains are typically noted as well.

STANDARD DRAWINGS

Almost every bridge construction contract has features in common with bridges of similar design, size, or location. Such items include railing details, pile splicing methods, details on bearing assemblies, and many other items. Producing new drawings for these features each time they are to be included on a contract would be time-consuming and repetitive. Instead, plans for such items are included in the INDOT Standard Drawings.

BRIDGE SUMMARY AND ESTIMATE OF QUANTITIES SHEETS

The bridge summary sheet tabulates the quantities of materials used in each part of a bridge.

CONTRACTOR PLANS OR DRAWINGS

In addition to the plans and drawings furnished by INDOT, working drawings may be supplied by the Contractor. Working drawings indicate the Contractor's proposed methods to meet the requirements of the contract plans, Special Provisions, and Standard Specs. In all cases, Contractor working drawings must be submitted and approved by INDOT or an assigned designee. Working drawings for forming or falsework must be signed and stamped by a Professional Engineer licensed in Indiana. INDOT then reviews all drawings.

The following items require approval by INDOT:

1. Falsework and cofferdam working drawings
2. Working drawings for the fabrication and erection of structural members
3. Deck pour plans and sequence
4. Traffic control plan alternatives
5. Erosion control plan

Any work done prior to the receipt of approved working drawings is done at the Contractor's own risk. Contractor drawings are approved for design features only, and do not relieve the Contractor from responsibility regarding errors or adequacy and safety of work. (SS **105.02**)

CONSTRUCTION CONTROLS AND LAYOUT

HORIZONTAL CONTROLS

To ensure the bridge lines up correctly with the approach roadways, the initial survey and layout establishes one or more centerlines to guide the construction of the bridge. The important lines for the Construction Engineering subcontractor to check include:

1. The centerline of construction, referred to as *baseline of construction* or *survey line*
2. The centerline of structure
3. The centerline of roadway
4. The centerline of bearing, sometimes called *centerline of pier* despite distinctions

Depending on the contract, the centerlines of construction, structure, and roadway may be the same line or three different lines. For example, a two-lane bridge with no shoulders or with shoulders of equal widths would probably have one line for all three references. In most cases, however, one or more centerlines are distinguished and differentiated.

Centerlines of bearing are transverse lines for the bridge seats or bearing areas on abutments and piers, or *bents*, and intersect the longitudinal centerlines. Generally, if the centerlines of bearing intersect the longitudinal centerlines at an oblique angle (any angle that isn't 90°), the bridge is said to be skewed or built on a skew. If the centerlines of bearing intersect the longitudinal centerlines at right angles, there is no skew. Degrees of skew, if any, are noted on the General Plan sheet and elsewhere on the plans.

VERTICAL CONTROLS

To maintain the proper grade of a bridge and the elevation of various bridge components, all construction is required to be referenced to benchmarks. Benchmarks are part of a system of control points maintained by the US Geological Survey to guide elevation measurements, and

are used on bridge construction projects to guide measurements for structure excavation, pile driving, pouring the deck, etc.

Benchmarks for bridges are established during the bridge layout and their locations are usually noted on the layout sheet. At least one benchmark on each side of the bridge is required to be checked for accuracy before construction begins. If a benchmark is on a structure that is to be removed, a temporary benchmark is established and protected at a site convenient to the new bridge. As soon as a footing, wingwall, or other permanent part of the new structure is poured, the temporary benchmark is transferred to the new structure.

BRIDGE CONSTRUCTION LAYOUT

Bridge layout and staking is normally done by the Contractor, or subcontractor, as Construction Engineering. Layout involves establishing construction control points that are used to maintain the horizontal and vertical alignment of the work that follows. After performing the layout, the Surveyor furnishes the Contractor with the information required to complete the layout and to conduct the work. Technicians who have little, or no survey work experience are encouraged to participate in the layout operation to acquaint themselves with the locations of important construction control points and the methods used to establish those points.

The first step in bridge layout is to locate previously established control points on each end of the bridge site. The control points were established during the preliminary survey to represent the baseline of construction or the survey line. This line is typically designated as Line "A" on the plans, though other designations may be used.

Control points for the centerline of the structure and/or roadway must also be located if they are different from the survey centerline. All points are checked for alignment and referenced with offset stakes. The station of one of the control points is determined for use in locating the abutments and piers.

The next step is to locate each unit of the substructure at points along the survey line. Reference stakes for these points are set to the left and right of the centerline by turning the skew angle. To ensure accuracy, the survey crew should double, and triple check the skew angle. The accuracy of the skew angle may be checked by measuring the distance between reference points on the left and right sides. If the distances between the points are equal on both sides, the skew angle is correct.

Enough reference points are set to ensure easy replacement of the centerline control. The reference points are protected and identified by guard stakes and flagging (plastic ribbons).

Once the reference points are set, the crew double-checks the elevations of the benchmarks. Again, temporary benchmarks are required to be established when a benchmark on an existing structure is to be replaced. If the bridge deck is to match an existing roadway, the edges and centerline of the roadway are required to be profiled and checked against the elevation of the new structure. This assures a smooth driving transition from the new structure to the existing roadway.

The last step in the bridge layout is staking the footings and taking cross-sections of the footing areas. The cross-sections are used to determine how much material the Contractor is required to remove during structure excavation.

CHAPTER TWO: FOUNDATIONS

This chapter includes information on the inspection of bridge foundations. The two activities most associated with the construction of bridge foundations are structure excavation and, when necessary, pile driving. Both activities are conducted to construct a foundation of adequate bearing that does not shift or sink under the loads that it supports. The soils at natural ground level rarely have sufficient bearing capabilities to provide this support. Through structure excavation, the unsuitable material at ground level is removed to expose denser, more compact material below.

In some cases, the foundation material exposed through excavation has adequate bearing. The footings for the bridge substructure units may be constructed and poured directly on the floor of the excavation. In many locations, however, there is not material of sufficient bearing for the footings. In those cases, foundation piling is driven to provide the necessary support.

Section 206 outlines the requirements for structure excavation and Section 701 describes the requirements for piling.

STRUCTURE EXCAVATION

Unless otherwise specified, structure excavation pay items includes all associated activities necessary to complete the work, including providing drainage, bracing, sheeting, and other incidental items. Backfilling the footings and disposing of unsuitable material are also commonly conducted and paid for under the pay items for structure excavation.

SOIL BORINGS

Before excavation for the footings begins, INDOT personnel investigate the underlying soils at the footing locations through soil borings. The soil borings indicate the types of materials below the surface and the elevations at which they occur.

The type of material at the footing locations determines, to a large degree, the bottom-of-footing elevation and whether piling is required.

The contract plans include a boring data sheet that illustrates where the borings were taken in relation to the structure. In addition, a boring profile of each site indicates the types of materials encountered and the elevations at which they occurred (Figure 2-1). Technicians are required to note the type of material found at the planned bottom-of-footing elevation. If the actual excavation contains material that differs greatly from what is shown in the profiles, the excavation limits and the footing design may have to be revised. The bottom-of-footing elevation on the profiles is required to be marked, if not already noted.

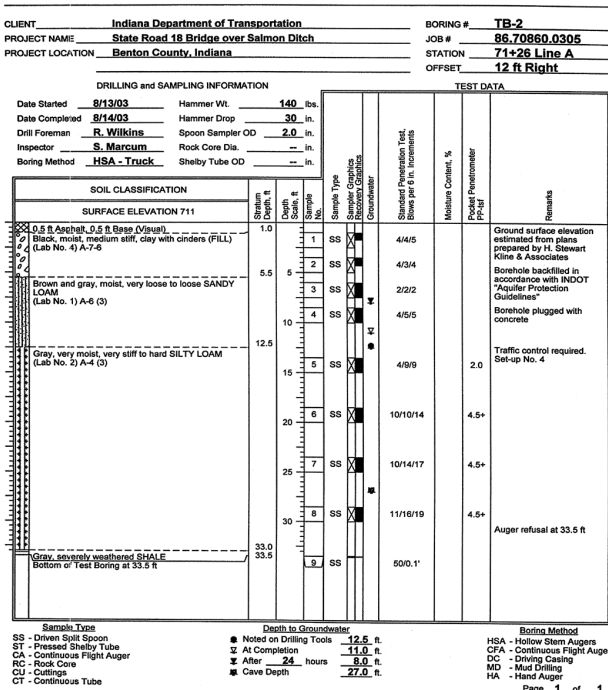

Figure 2-1 Test Boring Log

CROSS SECTIONS

Following the initial staking of the site, contract personnel (typically the Construction Engineering subcontractor) are required to take cross-sections of the footing locations to determine the volume of material that is required to be removed during the excavation operation. Once the excavation is complete, additional cross-sections are taken to measure the volume of material removed. Technicians are required to assure that enough cross-sections are taken to ensure accuracy. The Contractor is paid according to the volume of material removed and the class of excavation required.

CLASSES OF STRUCTURE EXCAVATION

The class of excavation required is determined by the nature of the material to be removed and the elevation at which the material is found. Sections **206.02** through **206.05** describe four classes of excavation.

CLASS X EXCAVATION

Class X excavation requires one or more of the following conditions:

1. The presence of solid rock, hard ledge rock, slate, hard shale, or conglomerate. Because the material cannot be reasonably removed by any other method, blasting or pneumatic or equivalent tools are required for removal.
2. The presence of loose stones or boulders that are more than $\frac{1}{2}$ yd³ in volume.
3. The presence of concrete, masonry, or similar materials that are part of an old structure that was not indicated on the plans.
4. The presence of timber grillages, old piling, buried logs, stumps, or other similar materials that extend beyond the limits of excavation and are required to be cut off. These materials are removed back to the cofferdam limits and paid as class X excavation.

Hard pan is not considered as class X excavation. The limits of class X excavation are the neat lines of the footer unless the excavation lies above another type of excavation (wet excavation, for example) whose limits are different. In this case, class X excavation is paid to the limits of the underlying material.

WET EXCAVATION

The plans usually indicate the upper limit of wet excavation with a horizontal line that represents the water line. Wet excavation requires the removal of material from that line down to the planned bottom-of-footing elevation. If the upper limit of wet excavation is not shown on the plans, an elevation of one foot above the low water level indicated on the plans is used instead.

Wet excavation is measured and paid for in terms of the theoretical amount of material bounded by the planned bottom-of-footing elevation, the upper limit of wet excavation, and the vertical planes 18" outside of the neat lines of the footing dimensions indicated on the plans.

DRY EXCAVATION

Dry excavation involves removal of material above the upper limit of wet excavation.

FOUNDATION EXCAVATION (UNCLASSIFIED)

Foundation excavation unclassified includes all required excavation that is not classified in the proposal as either wet excavation or dry excavation. Foundation excavation does not include class X excavation.

Structure excavation often includes a combination of these different classes. When there are overlapping classes of excavation, each class is required to be measured and paid for separately in conformance with the Specifications.

Except for wet excavation, all classes of structure excavation are measured and paid for according to the number of cubic yards of material that is removed from the original position and that is below the limits of roadway excavation.

LIMITS OF EXCAVATION

Structure excavation for footings is required to conform closely to the dimensions indicated on the plans and allow enough room for the construction of any necessary forms, bracing, or shoring. In most cases, the amount the Contractor may be paid for is 18" outside the neat lines of the planned dimensions. The Contractor may remove more than that for their convenience; however, in most cases this additional material is not paid for.

If the excavation material is material that is markedly different from what is shown on the soil borings data sheet, the Technician is required to immediately notify the PEMS of the discrepancy. The footing may require redesign. This is especially important as the excavation gets closer to the planned bottom-of-footing elevation.

To guard against unexpected problems with a foundation, Section **206.11** contains provisions to pay the Contractor if lowering the footings is required. This section describes the procedures to pay for the additional excavation for up to 4 ft below the planned bottom-of-footing elevation. Excavation exceeding 4 ft below the planned bottom-of-footing elevation is paid for as additional work. (Sections **104.03** and **109.05**). Where a footing or a portion of a footing is required deeper than the elevation indicated on the plans, such additional excavation (except for class X) that is carried down to a plane which is 4 ft or less below the bottom of footing or as indicated on the plans, is paid for as extended dry excavation, extended wet excavation, or extended foundation excavation unclassified.

The price is determined by multiplying the contract unit price for dry excavation, wet excavation, or foundation excavation unclassified, respectively, by the following factors:

1. For footings or portions lowered not more than 1', the factor is 2.0
2. For footings or portions lowered more than 1' and not more than 2', the factor is 2.5
3. For footings or portions lowered more than 2' and not more than 3', the factor is 3.5
4. For footings or portions lowered more than 3' and not more than 4', the factor is 5.0

DISPOSAL OF EXCAVATED MATERIAL

Excavated material is required to be kept away from the edge of the excavated area to guard against cave-ins. A good rule of thumb is to store the spoil pile no closer than a distance equal to the depth of the excavation. For example, the spoil pile should be kept at least 5 feet away from the edge of an excavation that is 5 feet deep.

The Contractor is required to also guard against runoff and erosion, especially in areas near rivers or streams. Erosion and pollution controls indicated on the plans are required to be implemented and maintained. Requirements for Temporary Erosion and Sediment Controls are discussed in Section **205**. The plans, special provisions, and Standards are good resources for any erosion control measures that are required. The Technician is required to be familiar with the requirements of the Erosion and Sediment Control Plan. DNR permits also have additional erosion control requirements that must be followed. These requirements must be reviewed prior to any foundation excavation. The Erosion and Sediment Control Plan is usually contained within the plans. A special provision may also be included in the contract. The DNR Permit is available from INDOT's website. The Erosion and Sediment Control Plan and any accompanying provisions are intended to be a guideline. The Contractor must make any adjustments necessary to the Erosion and Sediment Control Plan if the current plan shows deficiencies.

If suitable, excavated material is used to construct required embankments or as backfill once the footings have been built. Suitable material must meet the gradation requirements in Section **211.02**, and is classified as B borrow. Unless otherwise specified, B borrow is required in backfilling excavations for abutments, wingwalls, and piers up to the original ground line. Sometimes one of the other types of structure backfill will be required for backfilling. The Technician should check the plans to be sure the proper material is being used for backfilling. Compaction requirements and methods of measurement for B borrow and structure backfill are included in Sections **211.04** to **211.09**.

Excavated material that is unsuitable for backfill or embankment purposes is required to be kept separate from suitable material and disposed of carefully to avoid polluting nearby streams. If unsuitable material is removed from the right-of-way, this material is required to be placed in a location out of view of the traveled way. Written permission of property owners is required before placing or storing material on private property.

PREPARATION OF FOUNDATION SURFACES

If the bottom of the excavation consists of rock or other hard material, the bottom of the excavation is prepared by first removing all loose material, then cleaning and cutting the floor of the excavation down to a firm surface. Any seams or voids in the bottom of the excavation are required to be cleaned and filled with concrete, cement mortar, or grout. Ideally, the surface is level. In some cases, the bottom of excavation surface is stepped or notched so that the concrete footing keys into the rock foundation. This procedure guards against horizontal movement of the footing.

When the bottom of the excavation does not consist of rock or other hard material, and when foundation piling is not used, the bottom of the excavation preparation is done somewhat differently. The excavation is required to stop just short of the planned bottom-of-footing elevation. Final excavation is not completed until the Contractor is ready to pour the footing. At that time, the Contractor is required to complete the excavation, leaving the floor smooth and level and taking care not to disturb the foundation surface. The Technician is required to assure that the prepared foundation is exposed to the weather no longer than necessary.

For footings that are supported on piling, excavation is required to be completed to the planned bottom-of-footing elevation before pile driving begins.

SUBSOIL INVESTIGATIONS

Once the foundation excavation is complete, the PEMS is contacted to approve the depth of the excavation and the character of the foundation material. Test borings are required for foundations that do not require piling. For state-administered contracts, the Department's Geotechnical Engineering Division shall be contacted prior to proof-testing. For local public agency contracts, the Engineer shall be contacted prior to proof-testing. The borings are required to be at least 5 feet below the footing. If the foundation is a spread footing placed on rock, then the rock is required to be proof tested. Three 2" diameter holes per footing are drilled at a depth of 5 ft into the rock, and the following observations are recorded:

1. Speed of drilling
2. Drill pressure
3. Dropping or clogging of drill bit
4. Loss of drill water, if used
5. Probing of the sides of the holes with a right-angled chisel point
 - The chisel is required to be formed from a rod of $\frac{3}{8}$ " or $\frac{1}{2}$ " diameter.
6. Continuity of bearing material
7. Rock quality designation in accordance with ASTM D6032
8. Photos shall be taken of the rock core and the sidewall of the borehole from which core has been extracted.

A Professional Engineer is required to supervise the proof testing work. A report for each hole is prepared and submitted to the Engineer for review and approval.

If the findings of the foundation investigation are significantly different from what was described in the original boring data for the site, the results are required to be given to the District Area Engineer or to the Office of Geotechnical Engineering for evaluation.

DEWATERING EXCAVATIONS

Concrete for footings is ideally placed in a dry foundation. Water in the foundation alters and weakens the concrete. The Contractor may de-water an excavation by pumping or by constructing a sump to collect water outside the footing location. When a sump is constructed outside the pay limits of an excavation, the limits are extended to include the actual lines of the sump. The additional pay limits, however, do not exceed 4 % of the area of the footing involved. If they do, the Contractor is not paid for the excess excavation.

When groundwater continually enters the excavation from below, a layer of concrete known as a foundation seal may be required to seal the bottom of the cofferdam from the intrusion of water.

COFFERDAM CONSTRUCTION

Cofferdams (Figure 2-2), or temporary dikes, are often required when excavation work is done in stream channels, in unstable soils that may cave in without proper

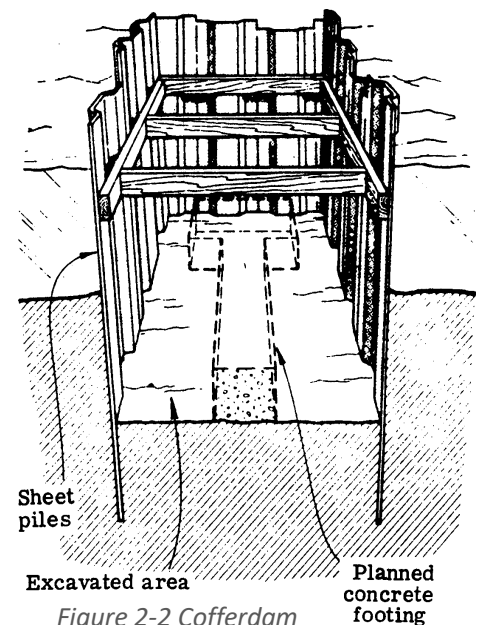

support, or near existing structures that may be disturbed by the excavation operation. Section **206.09** outlines construction requirements for the use and design of cofferdams temporary dikes. Cofferdams and temporary dikes are paid for either as a separate pay item (if one is specified as a pay item) or included as part of the structure excavation pay item.

Plans for the construction of cofferdams and temporary dikes are required to be submitted by the Contractor to the PEMS. The PEMS reviews the drawings only for compliance with the Specifications and specific contract conditions. If the Contractor begins construction before the plans are approved, the Contractor takes the risk of not being paid for that work in the event the plans are rejected or revised.

A typical cofferdam consists of sheet piling that has been driven deep enough to prevent scour and sufficiently braced to keep water and soil out of the excavation. Cofferdams are required to also be large enough to permit pile driving and the construction of forms when required.

Cofferdams must be as watertight as possible, so water pumped out stays out. The Contractor is required to be careful not to pump out any concrete once concrete placement begins. No pumping is permitted for 24 hours after the concrete placement unless approved by the PEMS.

When water continually infiltrates the cofferdam from the bottom and pumping is not a feasible method of de-watering, a foundation seal may be required, as described in Section **702.20(f)**. A foundation seal is a layer of class A concrete that is placed underwater inside a cofferdam through a tremie, which is a flexible tube made up of interlocking sections. Once the concrete is sufficiently hardened the water in the cofferdam may be pumped out, allowing the footing to be constructed in a dry condition. Foundation seals may be constructed by the Contractor only when they are required by the plans or requested and approved by the PEMS, and never simply to provide a convenient working platform on which to construct the footing.

Once the footing and pier stem or bent columns have been constructed, the cofferdams may be removed. The Contractor usually has the option of either pulling out the sheet piling entirely or cutting the sheet piling off two feet below the finished ground level. In any case, the Contractor is required to be careful not to disturb or damage the newly poured footing and pier stem or bent columns during the removal operation.

FOUNDATION PILING

Foundation piles are load-bearing members made of steel, concrete, timber, or a combination of these materials. They are typically used where the foundation soils are too unstable or compressible to provide adequate support for the structure. Once in place, the foundation piling transfers the loads from the substructure to the firmer underlying layers of soil or rock.

To support the structure above them, piles are required to be driven to the specified nominal driving resistance (formerly known as bearing), the point at which they do not sink or shift under the load. The nominal driving resistance and the minimum tip elevation to which piling is required to be driven is indicated in a Pile Driving Data Table on the General Plan sheet.

TYPES OF PILING

INDOT commonly uses three types of foundation piling:

1. Timber piles, both treated and untreated
2. Steel H-piles
3. Steel pipe piles filled with concrete, sometimes called *shell piles* or *steel shell encased concrete piles* as shown in Figure 2-3



Figure 2-3 Foundation Piles

DELIVERY AND ACCEPTANCE

When piling is delivered to the jobsite, the piling is checked to verify that the type of piling supplied is as indicated on the plans. Any major damage is required to be reported to the PEMS. All piling is required to be stored off the ground and supported in such a way as to minimize bending stresses. The General Notes section of the General Plan sheet usually specifies the type of piling to be used.

The second item to do is to inspect the delivered piling, making sure it is not damaged and that it is acceptable for use. Steel H-piles and pipe piles are required to be inspected for bends, kinks, rust, etc. Steel H-piles and steel pipe piles are accepted based on a mill test report that accompanies the piles. The mill test report contains heat numbers that identify individual piles. The Technician is required to compare the heat numbers in the reports to the heat numbers stenciled on the individual piles to assure that piles that match the mill test report have been delivered. The Technician should also check the mill test report to verify that the steel and the steel piles are manufactured in the United States of America.

Timber piles have a stamp in the shape of the State of Indiana hammered on the ends to indicate that they have been inspected. Untreated timber piles are stamped on one end and treated piles have stamps on both ends.

While checking for proof of inspection, the Technician must check the piling for significant damage or flaws. For example, treated timber piles are coated with a preservative to prevent or slow decay and to protect the piling from insects, and as the preservative treatment may not penetrate deep inside the wood, the outside surface must be completely covered. Also, timber piles that have been bent, twisted, or split prior to installation should be rejected.

PILE DRIVING HAMMERS

Contractors use large cranes equipped with pile driving hammers to drive piling to the required depth and bearing. Some common types of pile hammers are:

1. Gravity or drop hammers (only to be used when approved)
2. Single or double acting steam and air hammers
3. Diesel hammers
4. Hydraulic hammers
5. Vibratory hammers

All pile hammers to be used on a contract must be inspected and approved. The Contractor shall furnish the PEMS with copies of the manufacturer's tables, charts, and data necessary for determining the nominal driving resistance values, or *bearing*, of pile driven with the hammer to be used. The Contractor is required to submit for approval a completed Pile and Driving Equipment Data Form, available on INDOT's website, at least 15 days before starting to drive piling. The pile driving equipment may not be used until the Office of Geotechnical Engineering has approved the pile driving system in writing. The pile driving equipment is required to also perform satisfactorily during the installation of the piling.

GRAVITY HAMMERS

Gravity hammers (Figure 2-4) are the simplest type of pile hammer. Their major parts include the hammer – a large, heavy weight of approximately 3,000 to 3,500 lb – which is raised no more than 15 ft by a crane and dropped repeatedly onto the head of a pile. The hammer and pile are kept aligned by leads and guides. The top of the pile is protected by a pad and by a cap that is shaped to fit the pile.

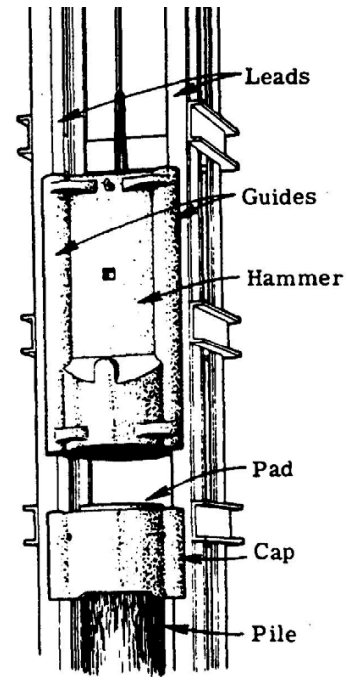

Figure 2-4 Gravity Hammer

Gravity hammers may only be used if the contract documents allow or if approved in writing. Gravity hammers are not commonly used on INDOT contracts.

STEAM AND AIR HAMMERS

Steam and air hammers operate like diesel hammers except that they are powered by steam or air. Such hammers with one explosion chamber are called single-acting hammers while those with two are called double-acting hammers. The plant and equipment furnished for steam and air hammers is required to have sufficient capacity to maintain, under working conditions, the volume and pressure specified by the manufacturer of the hammer. The plant and equipment is equipped with accurate chamber pressure gauges which are accessible to the PEMS. The Technician must monitor the pressure gauges to note the energy being supplied. Like gravity hammers, these are not commonly used on INDOT contracts.

DIESEL HAMMERS

Diesel Hammers (Figure 2-5) are the most common type of pile hammers used in Indiana and come in *open-top* and *closed-top* varieties. These hammers deliver blows through free fall, just like gravity hammers, with the difference being the hammer's return trip. While a gravity hammer raises the hammer with a cable, a diesel hammer raises the hammer or piston by the force of a small explosion in a chamber located at the bottom of the cylinder.

Open-top diesel hammers allow the Technician to witness each *stroke* – the height the piston rises above the top of the cylinder. Closed-top diesel hammers have a second chamber at the top of the cylinder. This chamber may be a second explosion chamber or a simple bounce chamber. Either type increases the energy output of closed-top hammers beyond that of open-top hammers.

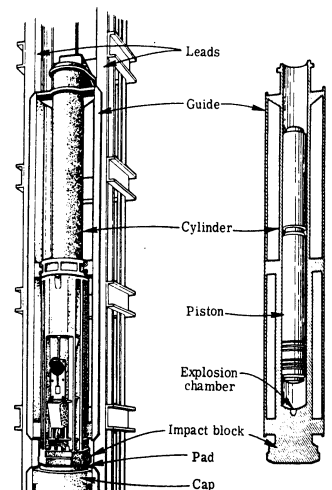

Figure 2-5 Diesel Hammer

HYDRAULIC HAMMERS

Hydraulic hammers are sometimes used in place of diesel and air hammers for driving steel pipe or timber piles. Hydraulic hammers tend to generate less noise and pollutants than diesel hammers and may be used when there is limited vertical clearance above a foundation. These hammers are not commonly used on INDOT contracts.

VIBRATORY HAMMERS

Vibratory hammers are commonly used when installing sheet piling or in situations where the vertical clearance above the foundation is limited. They are also used to remove piling. These hammers contain a system of counter-rotating eccentric weights designed to cancel out horizontal vibration while transmitting vertical vibrations into the pile.

ENERGY OUTPUT

Pile hammers are rated according to their energy output, which is the force of the blows they deliver to the top of the pile, measured in foot-pounds. The PEMS is required to obtain from the Contractor the energy ratings list for all hammers that are to be used on the contract.

For gravity hammers, the energy output is measured by multiplying the weight of the hammer by the height of the fall. A hammer that weighs 4000 lb and drops 10 ft through the leads and onto a pile develops 40,000 ft-lb of energy per blow.

For single or double acting steam and air hammers, the weight of the striking parts of air and steam hammers is required to be at least one third of the weight of the drive head and the pile being driven. The striking parts are required to weigh a minimum of 2,750 lb. If a wave equation is used for the approval of a single or double acting steam and air hammer, the weight of the striking parts must be as provided in the approval.

For open-top diesel hammers, the energy output is calculated as 80% of the weight of the hammer times the height of the fall or .80 WH. The energy output for closed top hammers is calculated as 80% of the manufacturer's rating.

BEARING AND REFUSAL

Piles obtain driving resistance (or bearing) from friction, end bearing, or a combination of friction and end bearing.

A pile obtains driving resistance from friction as it is driven into the ground and displaces the surrounding soil. The soil tightens around the pile, causing surface or skin friction on the pile. As a result, progressively more force is required to drive the pile deeper. The point where the amount of force needed to drive the pile deeper equals the estimated load the pile is required to support is the point at which the pile obtains its nominal driving resistance or bearing.

Another way a pile obtains its driving resistance is from tip or end bearing. The piles are driven until their tips come to rest on rock or some other material firm enough to support the structure. Steel H-piles are commonly used as end bearing piles.

One more way a pile obtains driving resistance is from a combination of friction and end bearing. Again, steel H-piles and steel pipe piles are typical examples of piling that may obtain bearing this way.

NOMINAL DRIVING RESISTANCE

The nominal driving resistance is determined by the Office of Geotechnical Engineering from either the dynamic formula or the wave equation analysis.

The formula used to determine the nominal driving resistance for piling is listed in Section **701.05**. It should also be listed on the pile hammer manufacturer's rating sheets. Again, the minimum nominal driving resistance is shown on the plans. The proper method, indicated in the contract documents, is required to be used to determine the nominal driving resistance for piling. The options that are listed in the specifications include wave equation analysis program, or *WEAP*, dynamic formula, dynamic pile load test, or the static load test.

WAVE EQUATION ANALYSIS PROGRAM

With the wave equation analysis program, the pile capacity is determined based on the pile capacity versus blow count relationship obtained from the wave equation analysis.

DYNAMIC FORMULA

The nominal driving resistance may be determined by means of dynamic formula. Piles are required to be driven to the length necessary to obtain the nominal driving resistance. The nominal driving resistance, as shown on the plans, may be calculated from the formula as follows:

$$R_{ndr} = 1.75\sqrt{E} \times (\log 10N) - 100$$

where:

- R_{ndr} = The nominal driving resistance, in kips
- E = The manufacturer's rated energy in foot pounds at the field observed ram stroke, not reduced for efficiency
- N = the number of hammer blows per 1" at final penetration.
- $\log 10N$ = Logarithm to the base 10 of the quantity 10 multiplied by N

DYNAMIC PILE LOAD TEST

Dynamic measurements are used to evaluate hammer and driving system performance, pile driving stresses, pile structural integrity, and pile capacity. Dynamic monitoring is conducted by the pile driving analysis (PDA) consultant in accordance with **ASTM D 4945**. This test is common on INDOT contracts.

STATIC LOAD TEST

The test pile capacity is verified by conducting actual loading tests of designated piles in the structure in accordance with **ASTM D 1143**, quick load test method, with loads applied by hydraulic jack. The load is applied in small amounts over time. The safe allowable load is determined from the settlement versus load curve generated by the incremental loading in accordance with Section **701.05(c)**.

TEST PILING

If shown on the plans, the Contractor is required to drive an indicator test pile in each bent or pier that requires piling. The plans may indicate that a PDA test is required. Typically, these are

one per structure. Test piles are used to confirm the bearing values at the pile tip elevation shown on the plans and to determine or confirm the length of the foundation piling needed.

After the test piles have been driven, they are typically included in the final structure as foundation piling. Because of this, test piles are required to be of the same type and meet the same requirements as the remainder of the piles to be used at that location.

All piles are required to be measured and marked at one-foot intervals from the tip to the butt. Beginning 5 ft or so from the point where the pile would reach the minimum tip elevation indicated on the plans, the marks are required to be made at 1" intervals. The 1" marks help determine the rate of penetration at the time the pile reaches the specified driving resistance or is driven to refusal.

Generally, test piles are required to be 10 ft longer than the length indicated on the plans so, if the piling does not reach bearing at the planned tip elevation, the Contractor can drive the pile an extra 10 ft to verify if bearing may be reached at a slightly lower elevation. The Contractor may also splice test piles, with the permission of the PEMS, if additional length is required to reach bearing. All splices are required to conform to the methods detailed in Standards **701-BPIL-02, 701-BPIL- 03, 701-BPIL-04,** and **701-BPIL-05.**

To secure the most accurate bearing data possible, test piles are required to be driven to the final depth in one continuous operation (i.e. no splicing). Stopping and restarting the pile driving operation may distort the results. If driving is discontinued for any reason, the Technician is required to record the tip elevation of the pile at the time of shutdown and the duration of the delay.

Final depth is determined in one of two ways:

1. The pile has been driven to refusal
2. The pile has obtained both the minimum tip elevation and the minimum driving resistance requirement indicated on the plans

Once the necessary lengths are determined, the remaining foundation piling may be installed.

DRIVING FOUNDATION PILES

The Contractor may begin pile driving after the following:

1. The excavation has been completed to the planned bottom of footing elevation
2. The excavation has been dewatered
3. Sub-soil investigations, where required, have been conducted
4. The foundation has been approved by the PEMS
5. The correct type of piling has been delivered to the site and has been inspected and approved
6. Test piles, have been driven where required and results have been given to the PEMS

The location of each pile within a footing is shown on the substructure detail sheets of the plans. All piles are required to be driven within 6" of the planned location. Any pile driven outside this tolerance is required to be pulled back out and re-driven in the proper location. Pile tolerances are shown in **701.09(b)**. It is not acceptable to pull or push a driven pile back into alignment.

The plans indicate which piles are to be driven plumb (straight up and down) and which are to be battered (driven at an angle). Battered piles help to resist lateral movement of the substructure.

The Contractor is required to check battered piles with a level and a template cut to match the required angle (Figure 2-6). To ensure accuracy, the template is required to be placed against the pile, not the leads.

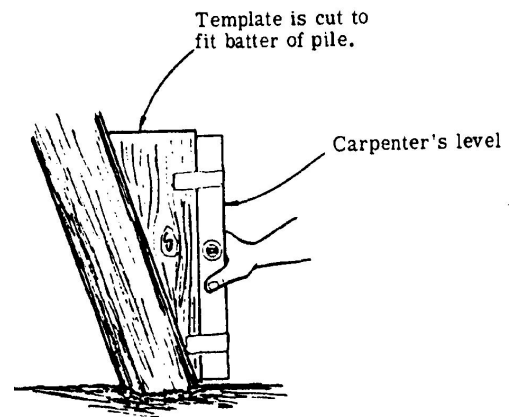

Figure 2-6 Battered Pile

The pile driving hammer is required to maintain a consistent speed, measured in blows per minute, and energy output, measured in foot-pounds, per blow during operation. Fluctuations in either speed or energy output causes unreliable bearing data. The Technician is to observe the penetration rate of the pile and count the blows per minute. Abrupt changes in either rate may indicate inconsistent hammer operation.

Open top diesel hammers and single acting steam or air driven hammers may be checked for consistent operation by observing how far the ram (or piston) projects from the cylinder on the upstroke of the cycle. If the ram projects the same amount over time, the Technician may assume the hammer is maintaining a consistent energy output.

Closed end double acting diesel hammers may be checked for consistent operation by monitoring the bounce chamber pressure gauge that is mounted near ground level.

Closed end or double acting steam or air driven hammers may be checked for consistent operation by monitoring the equipment that supplies the air or steam (the *plant*) and hammer for consistent pressure readings from the chamber pressure gauges. The readings are based on the manufacturer's requirements.

All piling is required to be driven until the piling reaches the minimum tip elevation and achieves the nominal driving resistance shown on the plans unless conditions at the jobsite prevent this procedure. Each pile is required to penetrate at least 10 ft below the planned pile cut-off elevation. The use of water jets may occasionally be required as an aid to penetration; however, water jets may only be used with permission. Jetting procedures and requirements are detailed in Section **701.04(c)6**.

In the event the required driving resistance is not achieved, even after the piles have been driven as planned or directed, the Contractor may use longer piles, use spliced piles, or drive more piles than called for on the plans with the permission of the PEMS. The total planned bearing value for each portion of the foundation is required.

Four conditions that are required to be met during pile driving for the nominal driving resistance to be obtained are:

1. The hammer has free fall
2. The head of the pile is not broomed or crushed
3. The penetration is at a reasonably quick and uniform rate
4. There is no observable bounce after the blow

These conditions, along with the proper and consistent operation of the hammer, help ensure that piling is driven to safe bearing.

After driving, all piles are required to be cut off to a true plane and at the specified cut-off elevation. The Contractor is required to also remove all heaved material between the piles and restore the excavation to the planned bottom-of-footing elevation.

The Technician is required to document all important aspects of the pile driving operation on Form IC 225, the Pile Driving Record. On the reverse side of the form, the Technician is required to provide a drawing of the pile layout. The locations of all test piles and battered piles are required to be noted as well. Accurate documentation is important when widening or replacing the bridge. Knowing what bearing the piling has for structural capacity analysis is also important.

DRIVING TIMBER PILES

The Contractor is required to take precautions to avoid damaging timber piles during driving. The head of the pile is required to be squared to insure full contact with the hammer and even distribution of the hammer blows. Most contractors use caps and pads to protect the head of the pile.

Piling with pointed tips may be used when required by the soil conditions as an aid in penetration.

Once begun, driving is required to continue until the pile reaches the required tip elevation and bearing. Driving may not be interrupted then resumed since this may result in an increased or false bearing value.

DRIVING PIPE PILES

The Contractor may drive pipe piles (or pile shells) with or without a removable core. Again, steps are required to be taken to avoid damaging piles during the driving operation. Caps or plates made to fit the head of the pipe piles are almost always required.

If the piling is to be driven through new embankment material, the Contractor is required to core holes for the piling through the embankment down to the original ground elevation. These holes are called predrilled holes (**701.09(a)2**). This procedure ensures the piles are driven into more solid, stable ground. When the contract requires reconstructing or replacing older structures, the existing fill and embankments of the older structure are considered as the original ground.

On occasion, the Contractor may be required to drive piling before the construction of the embankment, especially in areas where the embankment material is so sandy or permeable that pilot holes would not remain open.

Pipe piles are required to be inspected for damage after they have been driven. The Contractor is required to provide a suitable light for illuminating the interior of the pipe for inspection. Reflecting sunlight down into the pipe with a mirror works just as well. Any pipe pile that has been damaged significantly (major bends, breaks, or kinks) may have to be pulled out and replaced.

The Contractor is required to remove water and debris from the pipe piles before filling them with concrete. If the piles are not filled in a timely manner, they are required to be covered in some way to keep water out.

Pipe piles are filled with class A concrete. The concrete is required to be vibrated in at least the upper 25 ft of the piles.

DRIVING STEEL H-PILES

H-piles are required to be protected during driving by a suitable cap that has been grooved or in some other way shaped to fit the pile head firmly.

As with pipe piles, H-piles used for end bents may require predrilled holes, but only when the new embankment is 10 ft or more in height.

Standard **701-BPIL-01** includes the requirements for reinforced-concrete filled epoxy coated steel pipe piles and Steel H-piles reinforced concrete encased piles. Care is required to be taken to not damage the epoxy coating when driving epoxy coated piles and placing riprap.

MEASUREMENT AND PAYMENT

All piling is measured and paid for by the linear foot and at the contract unit price.

Steel pipe piles and steel H-piles are paid for based on the linear feet used in the structure. Cut-off sections, piles that were driven but rejected, and unused piling are not included.

Epoxy coated piles may be furnished and driven at lengths greater than those shown on the plans. Additional lengths of such epoxy coated piles left in place and accepted are paid for as epoxy coated steel pipe piles or steel H-piles.

If the quantity of driven piling is less than the plan quantity, INDOT will pay 50% of the cost to re-stock unused piling once the PEMS receives a copy of a paid invoice showing the re-stocking fee assessed to the Contractor.

CHAPTER THREE: *FORMS, FALSEWORK, AND REINFORCEMENT*

FORMS

Forms for concrete are like molds – they support and retain concrete in its desired shape until it hardens sufficiently to maintain its desired shape without the forms. No other factor has as much impact on the appearance of the substructure as the quality of the formwork.

BASIC FORM REQUIREMENTS

Forms are required to meet the following four basic requirements:

1. They are required to be rigid enough to confine plastic concrete at the lines, grades, and dimensions indicated on the plans without bulging or sagging under the load
2. They are required to be constructed as mortar tight as possible to prevent the loss of concrete ingredients through joints between the form sections
3. They are required to produce a uniform concrete surface texture, including aesthetic or rustication details when such treatments are specified
4. They are required to be easy to remove with minimal damage to the concrete surface

In addition to the above-noted general requirements, the Specifications also require that excavation and pile driving operations be completed before the Contractor begins to construct forms. This includes:

1. Completing excavations to the planned bottom-of-footing elevation
2. Removing material displaced by pile driving
3. Cutting off or driving piling to the correct elevation
4. Completing any special foundation treatment such as the placement of a specified backfill material or foundation seal

Figure 3-1 is an example of the formwork for columns in a bent.

FORM PLANS

There are no plans for forms as such. Rather, the Contractor uses the detail sheets contained within the plans to obtain the lines and dimensions of substructure units, then builds forms that will produce those dimensions and lines.

In addition to producing the correct lines and dimensions, forms are required withstand the pressure of plastic concrete. The faster the concrete is poured, the greater the pressure. If the concrete is poured too quickly, the walls of the form can fail. In general, the pressure is greater in taller vertical forms than in horizontal forms.



Figure 3-1 Bent Column Forms

FORM MATERIALS

Forms (Figure 3-2) for substructure concrete may be made from wood, metal, fiberglass, and even cardboard and fiber. No matter what materials are used, however, the important property of the forms is that they are strong enough to confine plastic concrete at the dimensions indicated on the plans without bulging, sagging, or failing under the load.

Form materials are required to be inspected for quality and condition. All form material that is in contact with exposed concrete surfaces, except for the undersides of girders, slabs, and arch rings, is required to be lined with approved plywood, metal, or other material that produces the desired surface texture. The lining is required to be clean and free of surface defects, grease, rust, or anything else that could mar or discolor the concrete. In addition, the interior faces of form panels are required to be coated with a formulated form coating material to make the forms easier to remove and to prevent concrete from sticking to the forms.

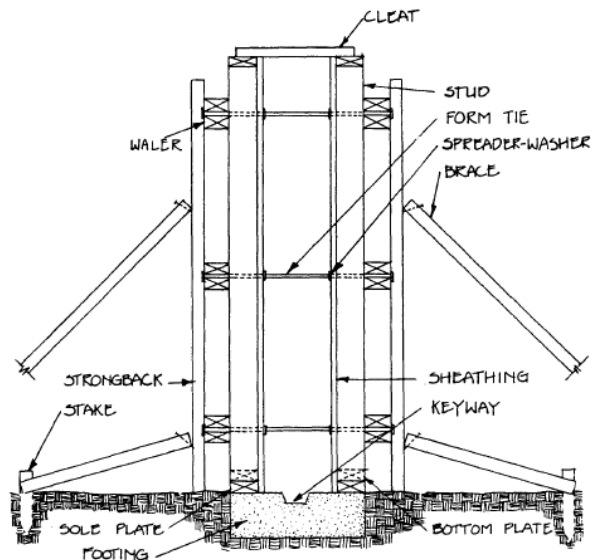
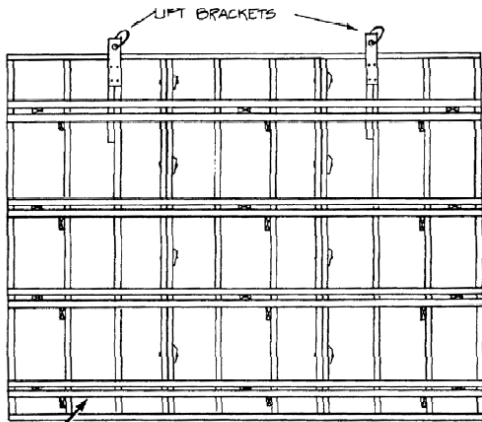

Figure 3-2 Concrete Forms



Walers
Figure 3-3 Wood Forms

Wood and metal are by far the most common form materials. A typical wood form consists of assemblies of 4 ft by 8 ft plywood sheets that have been braced vertically by studs and horizontally by walers (Figure 3-3). To provide maximum rigidity, good industry practice is to install the plywood sheets with the grain perpendicular to the studs. Studs should also be placed over all joints between the plywood sheets.

The Technician is required to observe that the lumber used is neither too green nor too dry. Green lumber tends to shrink after installation and create gaps between form panels that allow mortar to leak out. Lumber that is too old and dried out is subject to warping.

Many contractors build and use reusable wood forms. Reusable wood forms are acceptable until they become too flexible to hold the concrete at the correct lines. Surfaces of reusable forms are required to be checked closely for old concrete and other surface defects.

Metal forms (Figure 3-4) may be used in the construction of footings and for the walls of piers and abutments. These forms consist of ribbed metal panels that do not require additional studs and walers. When maintained in good condition and kept clean, metal forms may be used repeatedly.

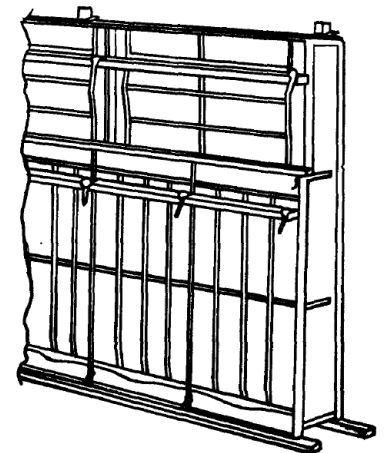

Figure 3-4 Metal Forms

Round forms (Figure 3-5) made of metal, fiberglass, or heavy fiber are used in the construction of round columns.

The sides of the vertical forms are held together by form ties (Figure 3-6). There are a variety of designs, but most ties include three parts: a spreader rod, bolts, and washers. Many contractors use snap ties. The ends of snap ties are designed to break off just below the surface of the concrete.

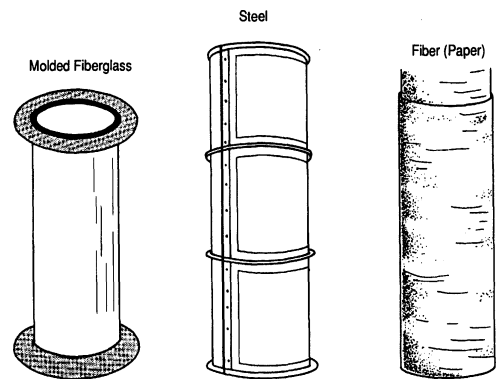

Figure 3-5 Round Forms

FORM CONSTRUCTION

During the construction of the formwork (Figure 3-7), the Technician is required to take measurements continually to ensure compliance with the approved working drawings for formwork. Important measurements to take include:

1. Length, width, and height. These measurements are compared to the dimensions indicated on the plans. Final elevation and alignment are required to be checked by contract personnel before approval.
2. Spacing of the studs and walers. Studs are typically spaced 12" apart center to center. The spacing of walers may vary. For example, some contractors space the walers near the bottom of the form close together to provide additional bracing against the pressure of the plastic concrete which is greatest at the bottom of the form. Other contractors may use oversized walers to provide extra rigidity and space them uniformly.
3. The clearance between the face of the forms and the reinforcing bars.

In most cases, the minimum clearance between the form and the bars is specified in the General Notes section of the plans and is typically 2".

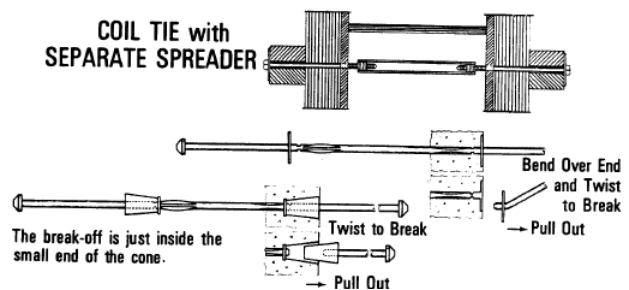

Figure 3-6 Vertical Form Ties



Figure 3-7 Formwork

INSTALLATION OF FORM TIES AND SPREADERS

The interior dimensions of vertical forms are maintained using form ties and spreaders. The ties are inserted between the walers on one side through the interior of the form, and then drawn through the walers on the other side. The tie bolts are tightened to draw the sides of the forms into the planned wall thickness.

The Technician is required to observe that the tie rods, which are left in the concrete, are installed so that there is sufficient concrete cover over the rod ends. One to two inches of concrete cover is typical. Insufficient cover over the rod ends may cause staining and spalling of the concrete surface.

The threaded section of tie bolts is required to be coated with an approved lubricant to make them easier to remove after the concrete pour. Only the threaded section of the bolts is required to contact the concrete. If an unthreaded section of a bolt becomes embedded, the bolt may not be removed without damaging the finished surface.

In addition to the form ties, the Contractor may also use temporary wooden spreaders and struts to maintain the interior dimension of the form. Spreader are used most often in tall, narrow wall forms. Wooden spreaders are not to be used, however, inside walls that are less than 2 ft thick. All wooden spreaders are required to be removed prior to the pour.

CHAMFER STRIPS

Unless otherwise specified on the plans, the Contractor is required to provide a $\frac{3}{4}$ " chamfer on all exposed concrete edges (Section **702.13(a)**). This is typically accomplished by installing chamfer strips in all corners where the concrete would form a sharp edge and at all other locations indicated on the plans. Chamfer strips are narrow, triangular pieces of wood. They provide the concrete with beveled edges which are less likely to chip or crack. Chamfer strips are also typically installed at the top of substructure units where they provide a beveled edge and serve to point out the upper limit of the concrete pour.

KEYWAYS

Formwork often includes the construction of keyways (Figure 3-8). Keyways are areas of raised or depressed concrete that are formed on top of footings and at construction joints where one section of concrete ties into the next section. The locations and dimensions for keyways forms are included in the plans.

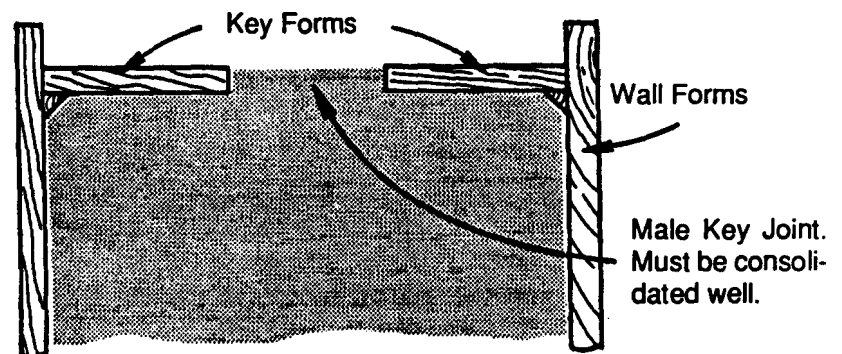

Figure 3-8 Keyways

PREPARATION FOR CONCRETE PLACEMENT

Prior to the concrete pour, forms are required to be checked with survey instruments for proper alignment and elevation. All trash and construction debris is required to be removed from the interior of the forms. When a form is too tall or narrow to enable easy worker access to the interior, the Contractor is required to build access panels near the bottom of the form to enable the removal of trash.

REMOVAL OF FORMS

Forms may not be removed until the concrete is strong enough to stand on its own without damage. On some contracts, the specific time required may be determined by the results of

concrete beam or cylinder strength tests (Section **702.13(h)**). Other contracts may use the following guide, excluding days when the temperature is below 40° F (Section **702.13(g)**):

- Centering under beams..... 15 days
- Roadway slabs..... 7 days
- Walls, columns, sides of beams, and all other parts..... 12 hours

All forms are required to be removed carefully so as not to damage the concrete. Regardless of the age of the concrete or the result of a concrete beam or cylinder test, the removal of forms is done at the Contractor's risk. Permission to remove the forms may be withheld if the PEMS considers that their removal may lead to damaging the structure.

FALSEWORK

Falsework differs from formwork in that falsework is temporary wooden or metal framework that is built to support the entire weight of a structure during construction. In bridge structures,

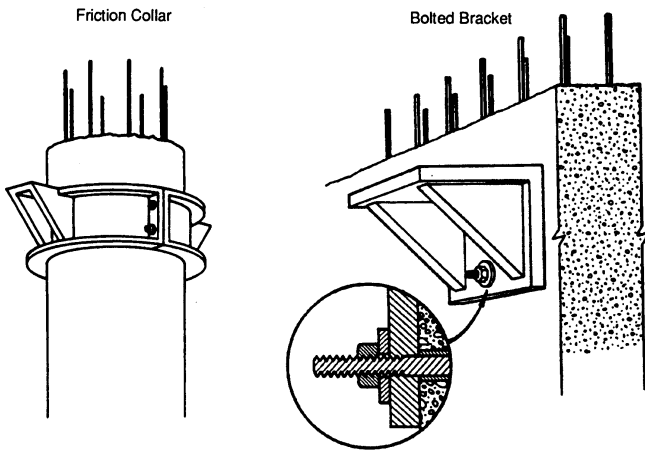

Figure 3-9 Falsework

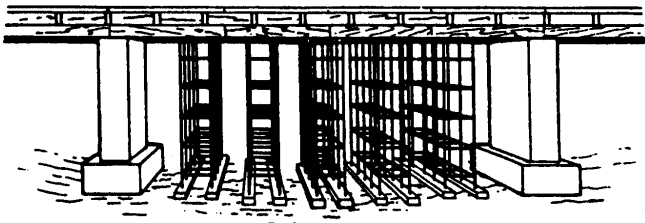

Figure 3-10 False Piers

falsework is used primarily to prevent form movement during and after concrete placement. Suitable jacks and other devices are often necessary to adjust and maintain the position of falsework during a pour. Once the concrete in the structure hardens sufficiently to be able to safely carry the full load with minimal deflection and settlement, the falsework may be slowly removed.

Falsework may range from very simple to very complex. Examples of simple types of falsework include brackets and friction collars which may be attached to columns to support forms for a pier cap (Figure 3-9).

A more elaborate example of falsework is a false pier (Figure 3-10) that is used to support a span between two permanent piers until the concrete slab or parapets harden sufficiently to be able to safely carry the full load without serious deflection. Falsework that bears on the foundation requires the use of mud sills, false footings, or temporary piling to provide additional support.

The Contractor is required to submit working drawings that indicate the plans for the use and construction of falsework. These drawings are required to be signed and stamped by a Professional Engineer licensed in Indiana and approved by INDOT. Approval of the falsework plans, however, does not relieve the Contractor of responsibility for constructing safe and accurate falsework.

The Technician should never take for granted that the falsework is adequate. The falsework is required to be monitored throughout the concrete pour and the curing period. Simple devices called tell tales (Figure 3-11) may be attached to the falsework to measure any settlement that

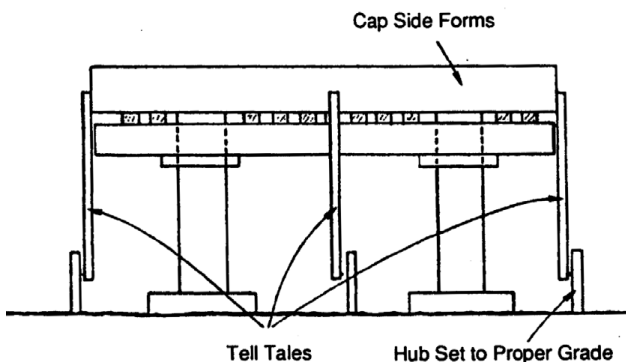

Figure 3-11 Tell Tales

may occur. If movement on the tell tales occurs during the pour, the Contractor is required to stop the operation and provide additional bracing. In some cases, a bulkhead or a construction joint is necessary, and the falsework is required to be modified before continuing the pour.

Section **702.14(b)** describes the conditions necessary to enable falsework removal. The procedure includes primarily the time and temperature requirements regarding specific parts of a structure. Removal of falsework may also be controlled by concrete beam test results, but only if specified on the plans or in a special provision. Otherwise, the time and temperature requirements control.

The falsework removal operation is required to be done slowly to allow the concrete to take on the weight gradually and uniformly. Like the removal of forms, the removal of falsework is done at the risk of the Contractor.

REINFORCEMENT

While formwork gives concrete its shape and texture, reinforcement (typically steel) gives the concrete strength. Specifically, reinforcement provides concrete with tensile strength, the ability to withstand bending stresses without cracking. Earth movement, wind stresses, and the movement of the superstructure because of expansion and contraction with temperature changes are examples of forces that may twist and bend substructure units. Without reinforcement, most concrete structures would crumble to the ground.

DEFORMED STEEL BARS

The most common type of reinforcement used in bridges is deformed steel bars. Deformed refers to the raised lines or ribs on the surface of the bars. These ribs enable the concrete to bond to the bars so the concrete may take advantage of the tensile strength of the steel. Smooth reinforcing steel bars would not provide as good a bond.

Bars are fabricated according to a bending schedule. The fabricator produces the required number of bars at the diameters, lengths, and shapes indicated on the detail sheets in the plans.

Many contracts now require the use of epoxy-coated bars throughout the structure.

IDENTIFYING REINFORCING BARS

Like many other construction materials, reinforcing bars have undergone a process of standardization. Bars are now manufactured and fabricated in the same standard sizes, weights, and grades of strength all over the country. The American Society for Testing Materials (ASTM) has developed an identification system for reinforcing bars (Figure 3-12).

The ASTM identification system has designations for bar sizes that are approximately equal to the number of $\frac{1}{8}$ inches in the diameter of the bar. For example, a #3 bar has a diameter of $\frac{3}{8}$ of an inch, a #4 bar has a diameter of $\frac{4}{8}$ or half an inch, a #6 bar has a diameter of $\frac{3}{4}$ of an inch, a #8 bar has a diameter of one inch, and so on.

Also note the column listing the weight of each size bar in pounds per foot. This weight is used in determining the Contractor's payment for reinforcing bars delivered and used on the jobsite.

The continuous line and number systems (Figure 3-13) are the two ASTM systems used for bar identification. Both systems include standard markings on the bars which are used to identify the bar producer, the bar size, the type of steel used, and the bar grade. The first mark is typically the initial of the mill that produced the bar. The second mark is the bar size (#3-#18). The third mark indicates the type of steel (new billet, axle, or rail). The difference between the two systems of bar identification is the way the bar grades are identified.

ASTM STANDARD REINFORCING BARS				
Bar Size (#)	Weight (lb/ft)	Diameter (in)	Cross-sectional Area (in ²)	Perimeter (in)
#3	0.376	0.375	0.11	1.178
#4	0.668	0.500	0.20	1.571
#5	1.043	0.625	0.31	1.963
#6	1.502	0.750	0.44	2.356
#7	2.044	0.875	0.60	2.749
#8	2.670	1.000	0.79	3.142
#9	3.400	1.128	1.00	3.544
#10	4.303	1.270	1.27	3.990
#11	5.313	1.410	1.56	4.430
#14	7.650	1.693	2.25	5.320
#18	13.600	2.257	4.00	7.090

Figure 3-12 Reinforcing Bar Standards

CONTINUOUS LINE SYSTEM: GRADE MARKS

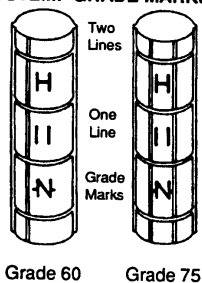
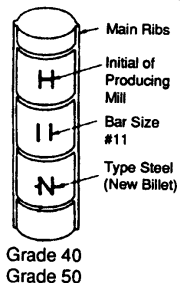

NUMBER SYSTEM: GRADE MARKS

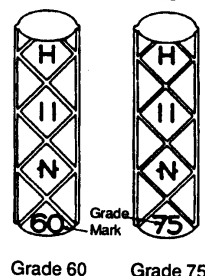
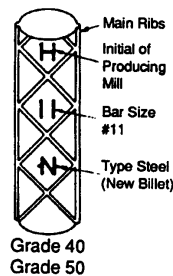

Figure 3-13 ASTM Bar Identification Systems

In the continuous line system, the grade of steel is indicated by one or two lines located between the main ribs of the bar. One line between the main ribs indicates the steel is Grade 60 (60,000 lb/in² yield strength) and two lines indicate the steel is Grade 75 (75,000 lb/in² yield strength). Lower grades of steel have no grade marks.

American Standard Bar Marks

Lower-strength bars indicate only 3 marks (no grade mark):

- 1st mark - Producing Mill (usually an initial)
- 2nd mark - Bar Size Number (#3 through #18)
- 3rd mark - Type (N for New Billet; A for Axle; I for rail)

High-strength bars are required to indicate grade marks: 60 or one line for 60,000 psi yield strength, 75 or two lines for 75,000 psi yield strength. Grade mark lines are smaller and between the two main ribs, which are on opposite sides of all American bars.

In the number system, grades are stamped on the bars numerically. Again, anything below Grade 60 does not have a grade mark.

Unless otherwise specified on the plans, all reinforcement is required to be deformed billet steel grade 60.



Figure 3-14 Reinforcing Bars

REINFORCEMENT DETAILS

The responsibility of the Technician for the installation of reinforcement (Figure 3-14) begins with a thorough review of the detail sheets for each unit of the substructure. These details indicate exactly what bars go where in the structure. Unless the plans say differently, all dimensions indicated for spacing, and clearance of the reinforcing bars apply to the centers of the bars.

Reinforcement information is in the Bill of Materials section on the detail sheets (Figure 3-15). This section lists the sizes, lengths, and quantities of all bars required for a particular unit of the substructure. Straight bars are identified by their size (for example, #10). Bent bars are identified by a three- or four-digit bar mark.

The first digit or first two digits of a bar mark indicate the bar size, from #3 to #18. The last two digits indicate the mark. The mark number, 01-99, is used to differentiate between bent bars of the same size and shape but of different lengths. The detail sheets also include drawings that illustrate the shapes of all bent bars to be used.

The letter "E" following a bar size or mark in the Bill of Materials section indicates that the bar is to be epoxy-coated. Alternately, since many contracts are requiring the use of epoxy-coated bars throughout the structure, there may be a note on the plans indicating that all reinforcement is required to be epoxy-coated instead of listing the "E" in the Bill of Materials.

Other useful information located in the Bill of Material section includes the quantity of each bar size and mark number required, the lengths required, the total weight of each size bar, and the total weight of all bars. Standard Drawing 703-BRST-01 for bridges contains additional notes on bending reinforcing bars.

BILL OF MATERIALS FOR BENT No. 2 E.B.			
REINFORCING STEEL			
Size or Mark	Number of Bars	Length (FT)	Weight (Lbs.)
10C1	100	8'-0"	
#10	100	20'-9"	
Total #10			16,244
909	28	41'-7"	
#9	28	38'-4"	
Total #9			7,560
806	113	11'-4"	
#8	60	36'-3"	
#8	71	9'-6"	
Total #8			12,963
603	64	16'-0"	
Total #6			1,538
#5	40	12'-5"	
#5	108	11'-0"	
Total #5			1,711
404	156	9'-0"	
405	84	3'-10"	
Total #4			1,153
301	140	12'-6"	
302	140	7'-10"	
303	140	8'-6"	
Total #3			1,307
Total Reinforcing Steel			42,876
CONCRETE			
Class "B" Concrete in Footing			648 CYS.
Class "B" Concrete above Footing			549 CYS.
Class "A" Concrete			
Pour #1			18.6 CYS.
Pour #2			4.0 CYS.
Pour #3			3.8 CYS.
Columns (5 @ 10.2 = 51.0 CYS)			51.0 CYS.
Total Class "A" Concrete in Substructure			76.4 CYS.
MISCELLANEOUS			
Surface Seal (222 SF)			1.8 Items

Figure 3-15 Bill of Materials

DELIVERY AND STORAGE

Reinforcing bars are typically delivered to the jobsite in bundles containing bars of the same size, mark, and lengths. Each bundle is identified by a tag that lists the number of bars in the bundle and their size.

Care is required to be taken to keep bundles intact and separated from other types and sizes of bars. The bars are required to be stored off the ground with enough supports to prevent longer bars from sagging and shorter bars from falling through. All bars are required to be covered to protect against rust, dirt, and water. As bars are removed from a bundle, the Contractor must re-stack the remaining bars and protect them with some type of cover.

Epoxy-coated bars require careful handling and storage. Nicks and cuts that go through the coating allow moisture to penetrate and eventually rust the bars. Any damaged area larger than ¼" by ¼" is required to be repaired before visible rusting occurs. Extensive damage to the coating may be cause for rejecting the bar. In addition to the protection requirements above, epoxy-coated bars are also required to be protected against exposure to sunlight since ultraviolet light damages and degrades epoxy. Section **703.04** defines extensive damage.

Reinforcing bars must be from certified manufacturers and coaters from the INDOT approved list. This means the reinforcement may be incorporated into the work immediately without additional job-site sampling.

INSTALLATION OF REINFORCEMENT

Inspecting the installation of reinforcement is required to ensure that the Contractor installs the correct bars in the correct locations. All bars are required to be properly secured to maintain the spacing and clearances indicated on the plans.

The Contractor may install the reinforcing bars piece by piece or assemble the bars into a cage or mat that may be lifted and placed inside the forms. When the bars are assembled outside the forms, the Technician is required to ensure that the bars are tied securely to prevent displacement during the installation. Tack welding of the bars is not allowed.

As the installation proceeds, the Technician is required to take measurements at random locations to ensure that the required laps, spacing, and clearances are maintained. The bars are required to be counted as used to ensure that the planned amount of reinforcement is being placed in the structural element.

Once the reinforcing bars are in place, the reinforcement should not be disturbed. Personnel are discouraged from walking on the mats unnecessarily. Any loose, broken, or missing ties are required to be replaced.

TYING REINFORCING BARS

Reinforcing bars are held in place by fastening intersecting bars with approved wire ties. Again, welding of bars is not allowed. The Specifications require the bars to be wired rigidly at sufficient intervals to hold the bars in place during concrete operations. Generally, this amounts to approximately 50% of all intersections being tied. In all cases, the ends of the wire ties are required to be bent away from exterior surfaces so they do not contact the finished concrete surface where they could rust and cause discoloration.



Figure 3-16 Form Clearance

CLEARANCES (CONCRETE COVER)

The clearance between the reinforcing bars and the sides of the forms determines the amount of concrete cover over the bars (Figure 3-16). Too little cover may lead to rusting of the reinforcement. Rust weakens the reinforcement and may also cause the concrete to crack and spall. As rust forms, the rust takes up space and creates pressure inside the concrete.

The plans indicate the amount of concrete cover required over the reinforcement. Typical coverage is 2" depending on the location within the structure. The required clearances may be maintained using approved metal supports or chairs (Figure 3-17) that are placed between the bars and the forms. The chairs are embedded into the concrete pour. Approved chairs have non-corrosive tips to prevent the tips from rusting and staining the exterior surface.

The clearance between the bottom layer or mat of reinforcement in a footing and the bottom of the footing is required to be maintained. Appropriately sized chairs may also be used here; however, some contractors use precast blocks instead. Other materials such as wood, stones, or broken concrete must not be used to support the bottom mat of reinforcing bars.

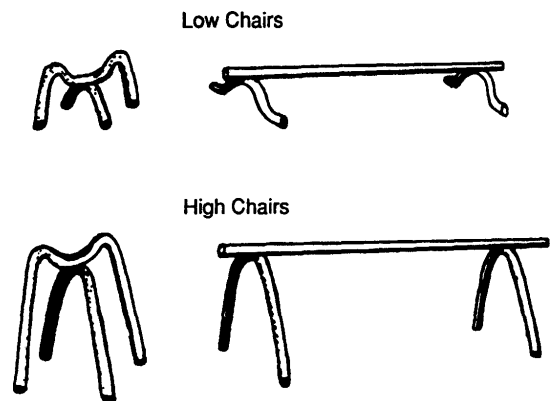

Figure 3-17 Form Chairs

BUNDLING AND SPLICING BARS

The plans may call for bars to be tied together vertically in pairs. This procedure is called bundling. In effect, bundling doubles bar strength. Bundled bars are generally found in the lower parts of tall forms where bending stresses are the greatest. Bundled bars should be tied together every 3 ft as a minimum.

While bundling bars is done to increase strength, splicing bars is done to increase length. Splices are made simply by overlapping two bars then tying them together (Figure 3-18). The length of the overlap is the critical factor and is dependent upon the diameter of the bar.

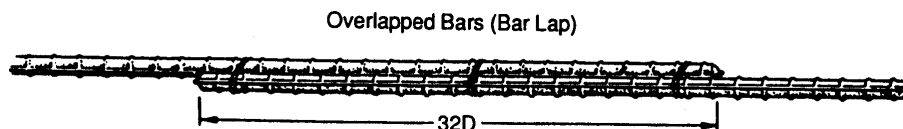

Figure 3-18 Overlapped Bars

The plans are required to indicate the length of the bar splice because the required splice length can exceed the general rule mentioned below. If the plans do not specify and no other splice length is given, the general rule is that spliced bars are required to overlap one another by at least 32 times the bar diameter. For example, #6 bars have a diameter of 0.75" Therefore, the minimum overlap for two # 6 bars is 32 times 0.75" or 24".

For spiral reinforcements in columns, a typical splice lap requirement is one and a half turns.

The Contractor is required to have the permission of the PEMS to splice bars in any location other than that shown in the plans. Because splices are relatively weak connections, too many splices in the same general area may weaken the reinforced concrete structure. The Contractor is required to stagger splice locations so that they are well distributed throughout the structure and located at points of low tensile stress.

Splices are not allowed at points with less than 2" of clearance between the spliced bars and the nearest adjacent bar. In general, bars that are size 14 and over may not be lap-spliced but may be mechanically spliced in some special cases. Section **703.06** states that construction joints may not be used within the limits of a spliced bar.

DOWELS

Lap requirements are especially critical for bars that function as dowels (Figure 3-19). These vertical bars are used to connect one section of the substructure to another, forming an integral unit. They are commonly used to tie a footing into a wall or column. If the dowels do not project into the upper section by the planned amount, the connection between the sections is weakened. The length of the bars and the distance they project into the upper section is shown on the plans.

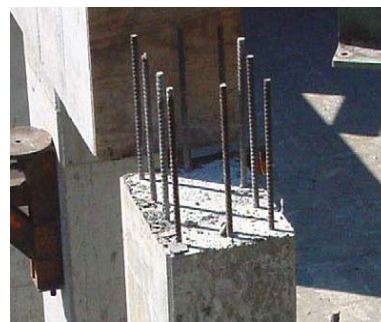

Figure 3-19 Dowels

BRIDGE SEATS

The spacing of the reinforcing bars in the bridge seat area is critical. Bars that are out of position could interfere with the placement of the anchor bolts for the bearing devices.

METHOD OF MEASUREMENT

Reinforcing bars are measured by the pound based on the theoretical number of pounds in place as indicated on the plans or placed in the work as ordered. The quantity of materials furnished and placed is based upon the calculated weights of the reinforcing bars placed in accordance with the Specifications. The weights may be calculated using the figures from the table in Section **703.07**.

BASIS OF PAYMENT

Both plain and epoxy coated reinforcing bars are paid for by the pound at the contract unit price. Only bars that have been accepted for quality of material and installation are paid for, and no additional payment is made for wire, clips or other material used for fastening the reinforcing bars in place. The cost of those items has been included in the contract unit price.

If the Contractor elects to use larger bars than the ones required in the plans, #10 bar instead of #8 bar for example, payment is based on the use of the planned size.

If the Contractor elects to use shorter bars simply to make transporting the bars easier and then uses unplanned but approved splices to obtain the necessary lengths, the weight that is paid is still based on the lengths shown on the plans. No additional payment is made for the extra length needed to obtain the required lap.

CHAPTER FOUR: *CONCRETE PLACEMENT*

CLASSES OF STRUCTURAL CONCRETE

Structural concrete is described in Section **702** and is produced as class A, class B, and class C. The differences between the classes are in the cement and aggregate contents and water/cementitious ratios. It is common to hear the latter phrase expressed as "water/cement" ratio, but it is more accurate – when other cementitious materials such as fly ash or slag cement (see Section **901.03**) are also used – to use the term "water/cementitious ratio". This ratio is an expression of the total amount of water, in pounds, divided by the amount of cementitious material, also in pounds, per cubic yard of concrete.

Bridge construction often requires the use of all three classes of concrete. For example, the plans may require class B concrete for the footings, class A for the piers and bents, and class C for the decks and railings. The Notes section of the General Plan sheet lists the classes of concrete to be used. The Bill of Materials section on the detail sheets also lists these classes. In most cases, the Contractor may substitute class C concrete for class A concrete and class A or class C concrete for class B concrete.

The materials used in the production of structural concrete include combinations of the following:

1. Fine and coarse aggregates
2. Portland cement
3. Water

Other commonly added materials are:

1. Fly ash (a coal-burning byproduct)
2. Slag cement
3. Air entraining admixtures and types A, B, C, D, E, F, and G concrete admixtures, which include retarders, accelerators, water reducers, and high range admixtures

CONCRETE PLANT INSPECTION

TYPES OF PLANTS

INDOT categorizes concrete plants as captive plants or commercial plants. Captive plants are usually temporary plants (constructed on the jobsite) and are used primarily to produce concrete for a specific contract. When the contract is finished, the plant is disassembled and moved. Commercial plants, on the other hand, are permanent installations.

Concrete plants are inspected and certified by the Division of Materials & Tests. Commercial plants are inspected once a year. Captive plants are inspected at the beginning of each construction season and whenever they are moved to a new location.

PREPARATIONS FOR CONCRETE PLACEMENT

The smooth delivery of concrete to the jobsite is critical. Delays in the delivery of the concrete during the placement operation may cause problems that are time consuming and costly to

resolve. The bridge Technician, Contractor, and concrete plant Technician, if available, should work to ensure timely delivery of necessary quantities of approved concrete. Almost without exception, plant Technicians will be available during deck pours.

PLAN REVIEW

Preparing for the delivery of concrete begins with a review of the plans. The class or classes of concrete are required to be checked. The Bill of Materials section of the detail sheets is used to locate the estimated quantities for each class of concrete. Substitutions of a higher class of concrete are generally allowed; however, the Contractor is never permitted to substitute an inferior class of concrete for the class of concrete required in the plans.

The detail sheets also provide important information concerning the concrete pour, such as the pour sequence and the locations and dimensions of construction joints and keyways.

SITE PREPARATIONS

The Technician is required to ensure that the site has been adequately prepared for concrete placement. Such preparations include that:

1. Excavations have been dewatered if concrete is to be placed in them (footings)
2. Forms have been checked for adequate bracing and proper elevations and alignment
3. Chamfer strips have been installed and are in good shape
4. Trash and debris have been removed from within all forms
5. Reinforcement has been tied securely and checked for proper clearance and spacing
6. The Contractor has adequate manpower and equipment to handle the pour, including enough vibrators and backups

Note: Contractors typically use a formulated form coating material on panel forms to facilitate removal after the pour. However, they must apply this material before enclosing the footing, wall, or other feature so that overspray of form oil does not coat the reinforcement. Oily reinforcing bars cannot perform the structural function for which they were designed if the concrete is unable to bond to the bars. Furthermore, mud, sawdust and other contaminants must be removed from the rebar for similar reasons.

WEATHER RESTRICTIONS

The Technician should be aware of the weather forecast for the concrete placement operation. Weather conditions may influence everything from the timing and method of concrete delivery and placement to postponing the operation altogether. Ideally, concrete is placed in temperatures between 50 and 90° F, when there is no threat of rain, and when steps have been taken to protect the concrete from excessive wind which can lead to accelerated surface drying and shrinkage cracking.

When the temperature is 40° F or below, the temperature of the concrete is required to be between 50 and 80° F at the time of placing. The Contractor may heat the water and/or aggregates used in the concrete mix to achieve this range of temperatures; however, the heating is required to be done in accordance with the Specifications for cold-weather concrete (Section **702.11**). The Technician is required to use a dial thermometer to check the concrete temperature.

CONCRETE DELIVERY

Concrete may not be placed without a Technician at the location of concrete placement and/or where the concrete delivery is received. Prior to the beginning of concrete delivery, the Technician should double-check the following items:

1. The class of concrete to be used
2. The quantity of concrete needed for the pour
3. The physical property requirements of the mix (percent air entrainment, slump, etc.)
4. The proposed starting time of delivery
5. The desired rate of delivery



Figure 4-1 Mixer Trucks

DELIVERY EQUIPMENT

Concrete is typically delivered to the jobsite in mixer trucks or agitator trucks. Rarely will it be delivered in non-agitating trucks. All delivery trucks are required to comply with the equipment Specifications designated in Sections **702.08** and **702.09**.

Mixer trucks (Figure 4-1) are designed for mixing concrete at or on the way to the jobsite. For this reason, mixer trucks always have a water tank on board and a measuring device that can control the amount of water added to the mix in transit. Agitator trucks deliver ready-mix concrete. Any water on the truck is for cleaning purposes only, not for mixing.

When mixer trucks are used, check the following:

1. Manufacturer's rating plates are in place and legible
2. Revolution counters are operating properly
3. Mixing speed and the number of revolutions are in compliance with the Specifications. The required drum mixing speed is between 70 and 100 revolutions per minute
4. Trucks are operated at or below their rated volume capacity

DELIVERY TICKETS

As concrete is delivered to the jobsite, a delivery ticket is provided for each truck. The ticket may be a paper form to be collected by the inspector from the truck or provided in an electronic format known as an e-ticket.

When e-tickets are to be used, the Contractor must either be approved to use the Department's e-ticketing platform or request approval from the PEMS to use an alternate e-ticketing system. Even with approval to use e-tickets, copies of the e-ticket in paper format may be requested of the Contractor at any time. If an alternate system is used, real-time access to the system must be provided, accessible via standard desktop and mobile operating systems. The Contractor must also provide the ability for an Inspector to acknowledge receipt of and accept e-tickets within their ticketing system, which would also be included in the potentially-requested paper copy of a given e-ticket. This functionality is also available in the Department's e-ticketing platform as well, as the Inspector's receipt and acceptance of a ticket, whether paper or electronic, is required to use the material on-site.

When the concrete delivered to the jobsite is produced at a commercial or captive plant, the Producer's ticket is used to document delivery. The Producer's tickets for each load of concrete delivered each day is required to contain the following:

1. The correct contract or project number
2. The correct date
3. The producer's name
4. The plant location
5. The Contractor
6. The class of concrete delivered
7. The weights per cubic yard of all materials, including admixtures
8. The number of cubic yards delivered
9. The time of day that the water and cement were combined
10. The plant Technician's signature, if applicable

After the first load is delivered, the Producer's name, the plant location, the Contractor, and the weights of the various materials used in batching may be omitted from the Producer's tickets for the rest of the day or until the mix design is changed. If the mix design is changed, the ticket for the first load of the revised mix is required to indicate all changes.

FIELD TESTS

Conducting concrete field tests are one of the most important duties of a Technician. Typical field tests include slump, air content, yield, and water/cementitious ratio. The equipment used to conduct the tests is required to be clean, in good shape, and capable of providing accurate results. The air meters (Figure 4-2) used in air content tests and the scales used in yield tests are required to be calibrated and approved. All test equipment is provided by District Testing.

The procedures for conducting slump, air content, modulus of rupture, and yield tests are detailed in the GIFE (*General Instructions to Field Employees*). The required frequency for conducting all tests is listed in the Frequency Manual. The frequency of tests listed, however, is a minimum and may be increased as specified by the plans, the Special Provisions, or by the PEMS. The following is a brief description of the purpose of each test.



Figure 4-2 Air Content Meter

Slump tests are conducted to determine the ability or tendency of fresh concrete to flow. Typical specification limits for slump for structural concrete are between 1" and 6" (Section **702.12**). Unacceptable slump measurements indicate improper or inconsistent mix proportions, especially with water content. Contractors are not permitted to add water simply to make the mix easier to pour. Any such change to the mix design requires prior approval.

Air content tests are conducted to determine how much air is contained in the concrete. In most cases, air has been purposely added or entrained in concrete to make the concrete more

durable. Allowable air content values may be found in Section **702.05**. Results outside the specified limits indicate a requirement to adjust the amount of admixture in subsequent batches.

Yield tests are conducted to determine the weight per cubic foot of fresh concrete which can be used to determine the cement content per cubic yard. Yield tests are not used to check the batching of any single mix component.

Modulus of rupture tests are conducted to determine when forms may be removed from a structure or to determine when a structure may be put into service (Sections **702.13(g)**, **(h)**). Modulus of rupture occasionally controls when falsework may be removed (Section **702.14**). This test requires placing fresh concrete in a beam mold and allowing the concrete to set and cure under the same conditions as the concrete used in the structure. The concrete is then removed from the mold and broken in a controlled environment by a beam breaker. The test results may then be used to make certain assumptions regarding the strength of the concrete used in the structure. A beam breaker can be used at the District Office or may be brought from the District to the field office to use on site.

To take or perform all these tests – and have their results qualify as acceptance criteria for material on an INDOT contract – the Federal Highway Administration (FHWA) requires that the Technician be *qualified* for the test method in question. To attain this qualification, the Technician must exhibit competency in written form and through accurately performing the test procedures while under the supervision of a Testing Department designee. The PEMS should work with the Technician to arrange a Testing representative to qualify the Technician for doing field tests. This should be done prior to any concrete needing to be tested for acceptance on the contract.

RECORDING TEST RESULTS

The results of the slump, air content, and yield tests are recorded and submitted on Form **IT 652**. Modulus of rupture tests are documented on Form **IT 571A**, and water/cementitious ratio is recorded on Form **IT 628**.

CONCRETE PLACEMENT

Compared to the preparations leading up to the pour and the testing, the actual placement operation is relatively simple; however, there are still items that may go wrong.

SEGREGATION

Segregation occurs when the coarse and fine aggregates used in the concrete separate and become unevenly distributed throughout the mix. The larger coarse aggregate sinks to the bottom while the fine aggregate rises to the top. Segregation always leads to an inferior quality of concrete. For the most part, however, segregation may be prevented with the use of proper placement equipment and techniques. Typical activities that can cause segregation include over-vibration and dropping (from a chute or transit bucket) the fresh mix from excessive heights to the point of placement.

Concrete is required to be placed as close as possible to the location the concrete occupies in the structure. The concrete should not be dumped in a central location and then spread to the location required in the structure (Figure 4-3).

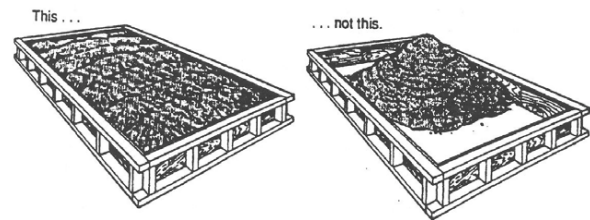

Figure 4-3 Concrete Placement

When placing the material within wall forms, concrete should be deposited in layers no more than 24" thick (Figure 4-4). Care is required be taken, however, to place each successive layer before the preceding layer has taken its initial set. This initial set usually occurs within 45

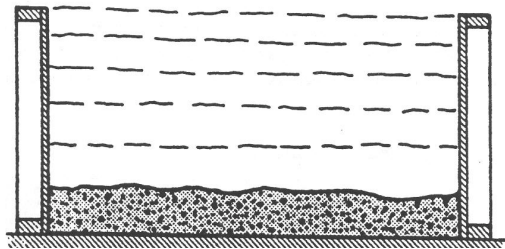

Figure 4-4 Concrete Layers

minutes to an hour after the concrete arrives on the jobsite, depending on the temperature. Too much time between the placement of layers usually results in a cold joint which is a weak line of separation between the concrete layers.

Dropping concrete from too great a height causes the finer particles in the mix to splash away from the larger, heavier particles and drives entrained air out of the mixture. In addition, the force of the mix striking the reinforcing bars may shift bars out of position or damage their epoxy coating. The maximum allowable free fall drop height is 5 ft. Hoppers with flexible chutes, called *tremies*, must be used to funnel the mix into tall, narrow forms.

Workers may be stationed inside a form to move chutes around, to ensure even distribution of concrete. A hopper may rest on the reinforcing bars, but only if the reinforcing is not moved or misaligned by doing so. Furthermore, if the bar is epoxy-coated, care must be taken not to damage the coating, and may require the hopper to be supported by the formwork instead.

Workers may be stationed inside a form to move chutes around, to ensure even distribution of concrete. A hopper may rest on the reinforcing bars, but only if the reinforcing is not moved or misaligned by doing so. Furthermore, if the bar is epoxy-coated, care must be taken not to damage the coating, and may require the hopper to be supported by the formwork instead.

CONSOLIDATION OF CONCRETE

Fresh concrete naturally contains air pockets, or voids. If the concrete was left that way, the finished product would have a rough surface and have questionable strength. To eliminate voids and ensure a good bond to the reinforcing bars, concrete must be consolidated to a uniform density.

The most common method of consolidating concrete is by vibrating the concrete with a portable spud type vibrator (Figure 4-5). Most vibrators have an effective radius of 18" around. Once a vibrator is inserted, it consolidates an area approximately 3 ft in diameter.

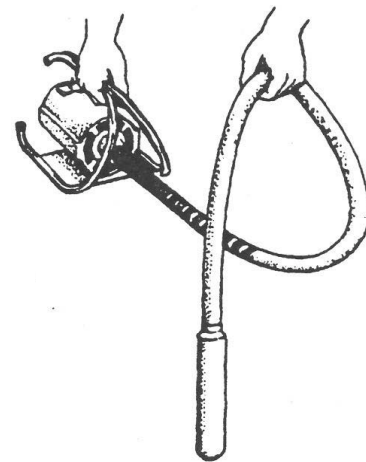

Figure 4-5 Spud Vibrator

Although the procedure is a simple operation, vibrating concrete is often conducted incorrectly. Some points to ensure a good product include:

1. Vibrating is required to be done immediately as the concrete is placed
2. Vibrators are required to be inserted and withdrawn vertically and should not be dragged through the concrete
3. Vibrators are required to be inserted and withdrawn within 5 seconds. Over-vibrating forces the finer aggregates to the top and drives the larger aggregates to the bottom

4. When concrete is poured in layers, the head of the vibrator is required to penetrate through the top layer and partially through the layer underneath (Figure 4-6)
5. The workers are required to avoid contacting the reinforcing bars with the vibrator so that segregation does not occur adjacent to the submerged reinforcement
6. The Contractor is required to have a backup vibrator on hand for all pours in case of equipment problems

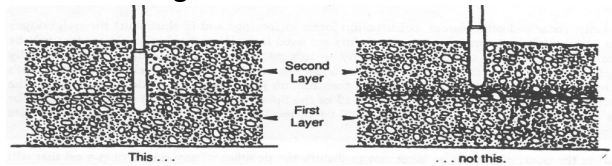

Figure 4-6 Depth of Vibration

CONSTRUCTION JOINTS

The purpose of a construction joint is to join a section of fresh concrete to a previously poured section that has already set. Construction joints are necessary when a substructure unit is too large to pour in one continuous operation or when rain, equipment problems, or other conditions interrupt the pour. Unless construction joints are specifically called for on the plans, the Contractor is required to have written permission to install a construction joint. Some construction joints, however, may be described on the plans as optional, and may be used at the Contractor's discretion. In addition, the Contractor may request the relocation or elimination of construction joints. Such a change is required to be approved by the PEMS.

To make a construction joint, either planned or unplanned, the Contractor is required to form a raised keyway or keyways in the section to be poured later. After the first section has hardened, the surface is cleaned thoroughly and kept wet. If a Type A joint is specified (Figure 4-7), the surface is notched between the reinforcement. Prior to placing fresh concrete, the Contractor is to apply an epoxy to the exposed surface to improve bonding (Section 702.20(a)). Immediately before fresh concrete is placed, the Contractor tightens the forms against the in-place concrete.

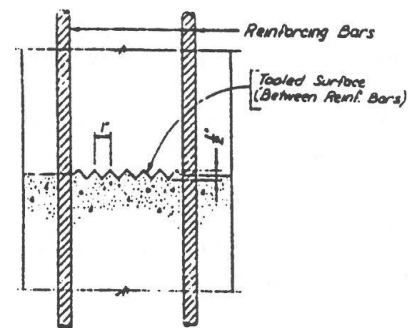

Figure 4-7 Type A Joint

To resist shear and other forces, construction joints in footings and in abutments for arch bridges are required to be vertical. Horizontal construction joints are used in walls and columns. Joints that are exposed to view are required to be constructed straight, clean, and watertight. This is done by finishing the concrete with the underside of a straight and level strip of wood that is nailed to the form at the proper elevation. No construction joint is allowed to be made in areas where the reinforcing bars have been spliced. Section 702.15 includes all the requirements for the use of construction joints.

During the pour, care is required to be taken not to disturb the position of any reinforcing bars that are used to tie the section being poured to a section that is poured later. If the bars are displaced, they are required to be re-tied immediately in the proper position. Concrete that is splashed on these bars is required to be cleaned off before the next section is poured to ensure a good bond. If the reinforcement is exposed to the weather for some time after the pour, the reinforcement may require coating with a cement paste to prevent the reinforcement from rusting.

SPECIAL CASES

The placement of concrete under water in footings and for foundation seals requires techniques outside the general rules given above. For a complete explanation of the methods and requirements, see Section 702.20(d) thru (f).

FINISHING CONCRETE SURFACES

Unless otherwise authorized, all concrete surfaces are required to be given a finish immediately following the removal of any forms. Only the minimum amount of covering necessary to allow finishing operations to be done is removed at one time. Subject to approval, metal ties may be left in the concrete for the purpose of supporting or bracing subsequent work. Such ties are required to be in accordance with Section **702.13(b)** and be of a type which uses a cone and rod as both spreader and tie. Before final acceptance of the work, the cones are removed and the cavities filled, in accordance with Section **702.13(b)**.

At the time of the removal of forms, the concrete surface is scraped to remove all fins and irregular projections. The surface is then power ground to smooth all joints and chamfers.

After grinding is completed, a paste of grout is applied to the surface with a sponge float to fill air holes and small irregularities. The paste grout is required to be 6 parts pre-mix masonry mortar and 1 part portland cement in accordance with **ASTM C-150**, type 1.

After the paste grout takes the initial set, the surface of the concrete is scraped with a steel drywall knife to remove the excess paste from the surface.”

FINISHING BEARING AREAS

The bridge seats and areas in between require special treatment at the finishing stage. The tops of the bridge seats are required to be finished at exactly the right elevation and be completely level to ensure full contact with the bottom of the bearing device. The areas in between the bridge seats are required to be sloped or crowned slightly to ensure adequate surface drainage. Both results are obtained through proper finishing techniques.

OTHER SURFACE TREATMENTS

The plans or Special Provisions may provide for the use of surface treatments other than the standard concrete finish. For example, the plans may require the Contactor to leave a rough surface texture of exposed aggregate. This may be done by blasting off the surface mortar with a high-pressure water hose.

The surfaces of pier and bent caps, the front face of mudwalls, and any other areas specified are sandblasted to remove form oil and other foreign matter and are required to be completely dry before the application of the sealer. The material used and application rate for sealing is required to be in accordance with Section **709**. Mixing, surface preparation, and the method of application are required to be in accordance with the manufacturer's recommendations. The sealant is applied in a crisscross pattern. No sealed surface is rubbed. Section **709** describes this operation in detail.

CURING SUBSTRUCTURE CONCRETE

Once the concrete is in place, the concrete is allowed to cure a certain amount of time to achieve the full strength. During the curing period, the concrete is not to be placed under stress. The typical curing period of the concrete is 96 hours after the initial set. The use of certain materials in the concrete, such as fly ash, slag cement, or Portland-pozzolan cement in the concrete, increases the curing period to 120 hours.

Section **702.22** describes two methods of curing concrete. One is called the protective covering curing method. This method requires covering the surfaces to be cured with burlap, or other approved material, and keeping the concrete wet with water throughout the curing period. The water prevents the concrete from drying out too quickly.

The other curing method requires the use of a membrane forming curing compound. The curing compound may be applied after the concrete surface has received the specified finishing treatment. Up until then, the concrete is required to be protected by the protective covering method or, in the case of vertical surfaces, simply by leaving the forms in place.

Curing compound is applied at a minimum rate of one gallon for every 150 ft² of concrete surface. The application is done in two stages. The first coat is applied immediately after stripping the forms or upon acceptance of the concrete finish. The surface is required to be wetted with water and coated with the compound as soon as the water film disappears. The second application is required to begin after the first has set and according to the manufacturer's directions. During the curing operation, all untreated areas are required to be kept wet.

Finally, the plans may call for certain areas to be waterproofed. When the application of waterproofing material begins, curing of those areas is no longer required.

COLD WEATHER CURING

In cold weather (40° F and below), the Contractor is required to keep the freshly poured concrete and the forms within a protective enclosure or covered with approved insulation material that is at least 2" thick. The air inside the enclosure or under the insulation is required to be kept above 50° F for at least 72 hours. If for any reason the temperature drops below 50° F within the enclosure, the heating period is required to be extended. When dry heat is used to maintain the required temperature, the Contractor is required to devise a means of providing enough moisture in the air within the enclosure to prevent the concrete from drying out too quickly. Heaters may be used to maintain the required temperature if they provide continuous operation, and the Contractor has taken adequate fire-prevention and safety measures.

When rubbing the concrete is required, the forms are removed, and the rubbing conducted during the protection period. Again, if this means that the concrete is exposed to temperatures below 50° F before the required 72 hours has transpired, the period of protection and heating is required to be extended.

METHOD OF MEASUREMENT AND BASIS OF PAYMENT

Concrete is measured and paid for by the cubic yard placed in accordance with the plans or as directed. Forms, falsework, and other miscellaneous items required to complete the work are not paid for separately. The costs for these items are included in the costs of the concrete.

CHAPTER FIVE: *BEARINGS AND STRUCTURAL MEMBERS*

BEARINGS

Bridges are not static structures that are incapable of movement. The bridge movements of most concern to the Technicians are caused by temperature changes. As temperatures rise, parts of a bridge, particularly in the superstructure, expand and get longer. As the temperature decreases, these same parts contract and get shorter. The movement may be barely discernible. A 15° F change in temperature may cause less than 1/8" change in the length of a 100 ft span. Although the movement may be slight, the force behind the movement is tremendously powerful. Unless a bridge is designed to accommodate the movement, the force eventually tears the bridge apart.

Bridge movement due to temperature changes is accommodated mainly using bearings which are devices that connect the structural members of the superstructure (beams and girders) to the supporting units of the substructure (bents, abutments, and piers). When designed and installed correctly, bearings permit the superstructure to move smoothly over the substructure without pushing the substructure units out of position.

EXPANSION, SEMI-FIXED, AND FIXED

Bearings may be classified as expansion, semi-fixed, or fixed. Figure 5-1 shows expansion and fixed steel bearings. Elastomeric bearings are commonly used as semi-fixed bearings. Standard Drawing series **726-BEBP** show elastomeric bearings. Expansion bearings are designed to permit movement. As the beam or girder expands and contracts, expansion bearings slide, rock, roll, or deflect along with the expansion or contraction. Fixed bearings on the other hand, are designed to hold the structural member above the member in place. Some fixed bearings permit a slight degree of rotational movement, but generally no movement back and forth. All but the shortest spans have at least one fixed bearing and one expansion bearing under each structural member to accommodate longitudinal movements. Semi-fixed bearings are commonly used in structures with integral and semi-integral end bents. These bearings permit some back and forth and rotational movement.

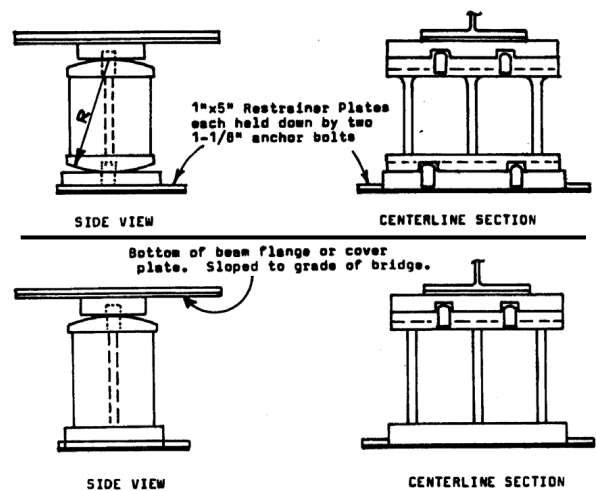

Figure 5-1 Expansion Bearing (top) and Fixed Bearing (bottom) assemblies

BEARING DESIGN

There are a wide variety of bearing designs. The current trend in bearing design is toward fewer moving parts that are simpler to install and maintain.

The classification of bridge bearings by function include:

1. Elastomeric devices
 - a. Simple elastomeric pads (or combined with polytetrafluoroethylene (PTFE))
 - b. Stacked pads with intermediate restraining layers
 - c. Circular restrained or "pot" bearings
2. Semi-Integral and Integral End Bents
 - a. Monolithic pour of approach, deck and end bent
 - b. Type I-A joint between approach slab and deck
 - c. Bearing portion of beams encased with concrete
3. Sliding Plates
 - a. Steel on steel
 - b. Steel on bronze
 - c. Lead sheets between steel plates
 - d. Bronze plates with graphite inserts
 - e. PTFE sliding on stainless steel
 - i. Steel plates faced with PTFE
 - ii. Fabric pads faced with PTFE
 - iii. Elastomeric pads faced with PTFE
 - f. Felt, oil and graphite, tar paper
4. Rolling Devices
 - a. Roller nests
 - b. Single rollers
 - c. Segmental rockers
 - d. Pinned rockers
 - e. Rack and pinions
 - f. Steel balls
5. Linkage or eyebear devices
 - a. Simple link hangers
 - b. Compression-tension struts
 - c. Pin connections permitting rotation but no horizontal movement
6. Other devices
 - a. Hydraulic cylinders or dashpots
 - b. Floating arrangements
 - c. Spherical bearings
7. Structural flexibility
 - a. Timber structures
 - b. Tall flexible piers
 - c. Curved bridge designs

INDOT commonly uses two types of bearing devices. For concrete structural members, elastomeric pad devices are typically used. For steel beam and girder construction, both elastomeric bearings and steel bearing assemblies are common. Some bridges do not use bearing devices. The other bridge bearings listed are not commonly used on INDOT bridges.

The use of integral end bents (Figure 5-2) has become more common in recent years. This design includes fixed beam ends encased in concrete. The pile cap/mudwall and deck are poured monolithic on the bent wall without the placement of any expansion material. The

beam ends are encased in concrete. The concept of this design is to prevent any road salt, moisture, or other foreign material from contacting the beam ends at the bearing position through a leaking bridge joint. Beams begin to deteriorate substantially worse at their ends when this occurs. The joint between the deck and approach slab is sealed with a standard type I-A joint.



Figure 5-2 Integral End Bents

ELASTOMERIC BEARINGS

Elastomeric bearings (Figure 5-3) meet most of the demands of modern bearing design. They are simple devices to install and maintain and do not freeze, corrode, or deteriorate. The reasons that an elastomeric bearing would fail are inferior materials, incorrect design, or improper installation.

Elastomeric bearings consist of layers of natural or synthetic rubber (neoprene) that are separated by thin sheets of steel or fabric. When the structural member expands or contracts, the bearings absorb the movements by stretching or deflecting along with the expansion or contraction. Because of their inherent ability to accommodate movement, elastomeric bearings are almost always used as semi-fixed bearings.

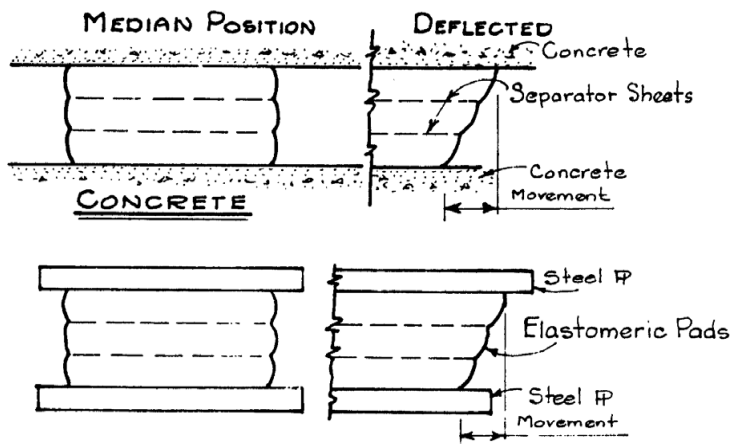

Figure 5-3 Elastomeric Bearing Pads

Elastomeric bearings may be secured to the bearing areas on the bridge seats in one of three ways:

1. They may be bonded or vulcanized to a steel bearing pad that is secured to the bridge seat with anchor bolts.
2. They may be glued in place using special adhesives.
3. They may be set in place simply by the weight of the members they support, as elastomeric bearings have shown little tendency to walk. However, this method does not safeguard against unusual conditions, such as movements caused by collisions or seismic events.

STEEL BEARINGS

The most common type of steel expansion bearings (Figure 5-4) or shoes used by INDOT consist of three major parts: a top shoe, an expansion roller, and an expansion plate. The top shoe, sometimes called a sole plate, connects the expansion roller to the beam or girder. The expansion roller is curved at the top and bottom to accommodate longitudinal movement through a rocking motion. The expansion shoe, sometimes referred to as a masonry plate, connects the expansion roller to the bridge seat or to a recessed anchor plate. The bolts that connect the expansion roller to the top shoe and the expansion plate are set into slightly

oversized or slotted holes. The extra room in the bolt holes gives the roller enough play to rock slightly backward or forward, depending on the movement of the member bearing supports.

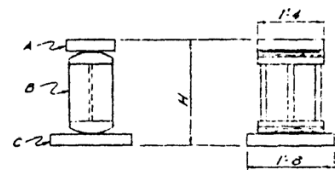

EXPANSION SHOE

SHOE TYPE	MAX. REACTION	SHOE ASSEMBLY			H
		A	B	C	
E-4	137 ^k	TS-4	EP-4	EP-4	1'-6 1/2
E-5	300 ^k	TS-5	EP-5	EP-5	1'-7
E-6	300 ^k	TS-6	EP-6	EP-6	1'-5 1/2

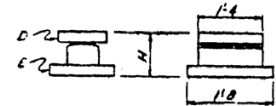

FIXED SHOE

SHOE TYPE	MAX. REACTION	SHOE ASSEMBLY		H
		D	E	
F-5	225 ^k	TS-5	FB-5	7 1/2
F-6	309 ^k	TS-6	FB-6	7 1/2

The fixed shoe or bearing device also has three sections: a top or sole plate, a fixed roller, and a bottom, masonry plate called a fixed base. The curved surface of the fixed roller allows for a slight degree of rotational movement but no movement back and forth.

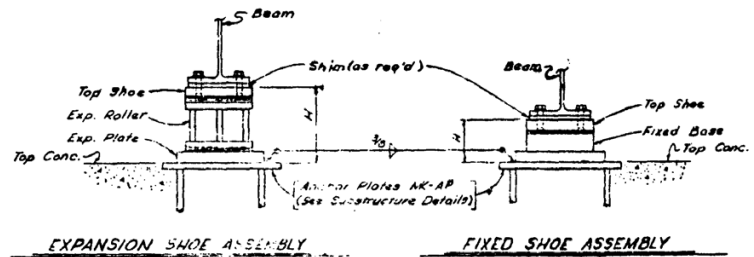

Figure 5-4 Steel Bearings

Anchor plates are also used on some fixed shoe assemblies to connect the shoes to the bridge seat. Additional steel shoe details are contained in the contract plans.

BEARING INSTALLATION AND ADJUSTMENTS

PREPARATIONS

Before permitting the Contractor to proceed with the installation of the bearing devices, the PEMS or the Technician is required to ensure the following items have been done:

1. Bearings are of the design specified in the plans
2. All materials have been approved by the Division of Materials & Tests
3. The General Plan sheet has been checked for general location of fixed and expansion bearings, and detail sheets checked for the exact layout of the bearings & anchor bolts
4. Each bridge seat has been checked for the proper elevation
5. The bridge seats are level to ensure full contact with the bottom of the bearing devices. Grinding of the concrete is done if necessary
6. Holes for the anchor bolts have been either formed or drilled in the proper location in relation to the span lengths, centerline of girder, and centerline of bearing

Each bearing plate is required to be accurately positioned and leveled in both directions.

TEMPERATURE ADJUSTMENTS

After the placement of the structural members, the position of the steel expansion bearings is required to be adjusted for temperature. Fixed bearings and elastomeric bearings require no adjustment, provided they have been installed in the correct position in the first place.

Before making any final adjustments for temperature to expansion bearings, the Contractor is required to remove any supporting falsework so that the structural members are under dead load. Also, the anchor bolts in the corresponding fixed bearings are required to be permanently set in the bearing seats and grouted.

Bearing adjustments for temperature are based on the following assumptions:

1. A beam or girder length of 100 ft
2. A mean temperature of 68° F
3. 1/8" of movement for every 15° F above the mean temperature

This means that at 68° F, the expansion roller in the steel shoe assembly is required to be completely vertical, not tilted away or toward the end of the fixed bearing. When temperatures are above 68° F, the roller is required to tilt away from the end of fixed bearing. At temperatures below 68° F, the roller is required to tilt toward the end of fixed bearing. The exact degree of tilt or offset from the vertical depends on the actual length of the beam or girder and the temperature at the time of installation.

Additional allowance for bearing adjustments is required to be made for deflection. Deflection is the lengthening of the beams as they are loaded and the camber decreases.

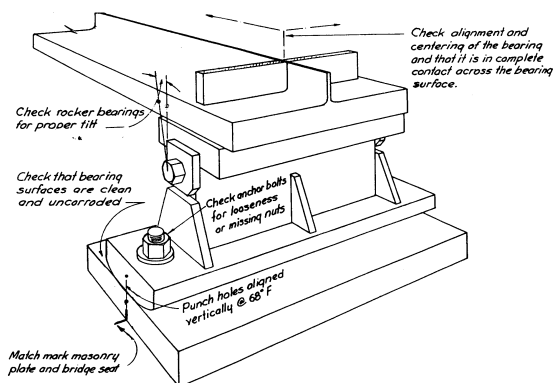

Figure 5-5 Bridge Inspection

In general, computing temperature adjustments and adjustments for deflection are done by the PEMS, and the adjustments are made by the Contractor. Technicians are required to be aware of the necessary adjustments and verify that they are done (Figure 5-5). This may simply require visually examining the position of each expansion roller to verify the roller is tilted in the direction expected for the temperature and that all rollers indicate the same degree of offset from the vertical. Once everything lines up correctly, the anchor bolts may be grouted permanently to the bridge seats.

The plans specify anchor bolt lengths and how far down the bolts are required to be set into the bridge seat which is usually a minimum of 1 ft. The threaded portion of the bolt is typically 4". After the anchor bolt nut has been tightened the required amount, the threads of the bolt are burred to prevent the nuts from being removed.

STRUCTURAL STEEL

The term structural steel generally refers to the steel beams and girders, as well as any transverse members such as diaphragms or cross frames used to transfer loads from the bridge deck and other parts of the bridge superstructure to the bearings. Structural steel is required to meet the material requirements listed in Section 910.02.

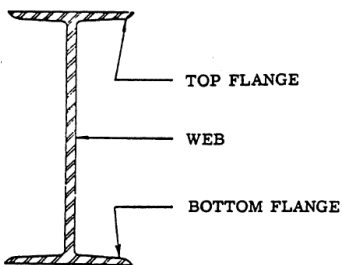

Figure 5-6 Rolled Beam

BEAMS AND GIRDERS

In discussing structural steel, the terms beam and girder have become almost interchangeable. To add to the confusion, a third term, stringer, is also used in many parts of the country. These are generally I-shaped members consisting of a wide vertical section, called a *web*, with more narrow horizontal flanges on the top and bottom (Figure 5-6). The differences between beams and girders are primarily the size and fabrication methods.

Beams are generally milled or rolled sections. They tend to be smaller in comparison to girders because their size is limited by the capacity of milling or rolling equipment.

A girder, on the other hand, may be made to virtually any size. That is because they are fabricated or built up rather than rolled. Fabricated girders consist of three plates that have been welded or riveted together to form an I-shaped member (Figure 5-7). Because of this method of fabrication, such members are often referred to as plate girders or built-up girders.

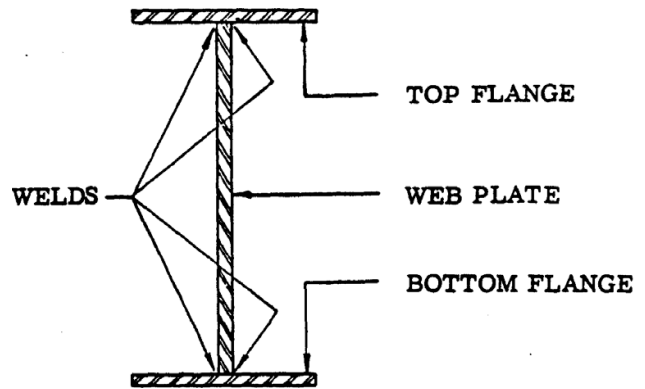

Figure 5-7 Welded Girder

Other shapes of girders a Technician may encounter are box and tub shapes. These shapes are not commonly used in Indiana, but can still be seen on a small number of bridges.

STIFFENERS

All but the shortest section of a structural steel member have several vertical braces called stiffeners attached to the web section to prevent the steel from buckling.

DIAPHRAGMS AND CROSS FRAMES

Diaphragms and cross frames are braces that are placed in between and connected transversely to adjacent beams or girders (Figure 5-8). Diaphragms and cross frames provide the beams and girders with extra rigidity against wind forces and other construction loads until the bridge deck is placed.

SPLICE PLATES

Splice plates are used to join steel members to form a longer section. These plates are bolted to the web and flange sections of the members through holes that have been drilled or reamed through the member generally at the fabrication shop although some field drilling or reaming is done.

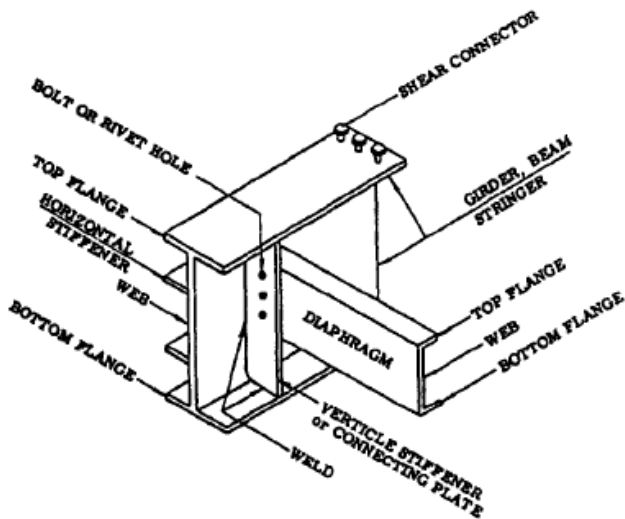
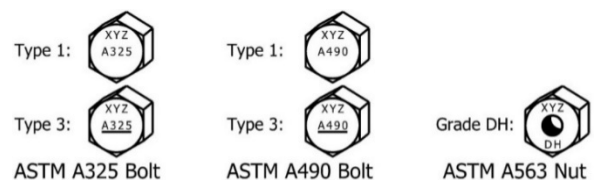

Figure 5-8 Stiffeners, Diaphragms, and Splice Plates

HIGH-STRENGTH BOLTS, NUTS, AND WASHERS

The fasteners used to secure splice plates and other connecting pieces are required to be in accordance with **ASTM F3125** (Section **910.02(g)**). High strength bolts, grade A325, are identified by the mark "325" engraved on the heads. Occasionally a contract will require **ASTM A490** bolts. These bolts will have markings on the bolt head (Figure 5-9). Depending on whether the type of structural steel is non-weathering steel or weathering steel, the bolts (and nuts and washers) may need to be type 1 or 3. High-strength nuts and washers have various markings depending on their grade. All fasteners used for securing the structural steel must have these marks and



Note: XYZ is the manufacturer's unique designation.

Figure 5-9 High Strength Bolt

are required to have been tested prior to use. Additionally, all bolts, nuts, washers, and similar threaded fasteners shall be either hot dip galvanized in accordance with **ASTM F2329** or mechanically galvanized in accordance with **ASTM B695**, Class 55.

SHEAR CONNECTORS

To "attach" or make the concrete bridge deck composite with the structural steel, shear connectors (Figure 5-10) or shear studs are welded to the top flange. These studs are later embedded in the concrete bridge deck and act to join the structural steel to the deck.



Figure 5-10 Shear Connectors

CAMBER

Nearly all beams and girders, both steel and concrete, are fabricated with some degree of camber. Camber is the slightly arched or convex curvature that is built into structural members

to compensate for the deflection or flattening out that occurs when the members are placed under a load. Without camber, the loads of the superstructure would cause the members to sag. With camber, the members form a more aesthetic and uniform profile. Figure 5-11 illustrates an exaggerated camber effect.

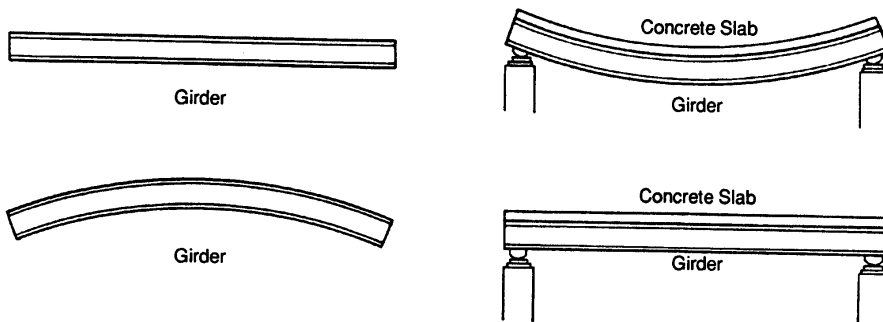

Figure 5-11 Camber

APPROVAL OF STRUCTURAL STEEL

Structural steel used on INDOT work is required to be produced by a mill located in the United States of America. A steel fabricator procures American made steel for use in fabricating the structural members called for in the contract. The fabricator is required to furnish copies of the steel mill test reports to prove that the steel meets the material requirements called for in the plans. Most structural steel is required to come from fabricators which are certified in accordance with Section **711.04**.

STRUCTURAL STEEL PLANS

CONTRACT DRAWINGS

INDOT contract drawings for structural steel include a framing plan and various structural steel detail sheets. The framing plan includes the fabrication and erection notes that outline the material requirements (steel, bolts, paint, etc.). Other information on the framing plan includes the lengths of all structural steel members, the locations of splices, the amount of camber in the spans, and the spacing of the shear connector studs. The detail sheets typically indicate such things as field splice elevations, splicing requirements, and bearing assembly details.

The detail sheet also includes a diagram to indicate which areas of the steel are in tension and which areas are in compression. Compression and tension forces are mainly applied to the flanges of steel beams and girders. On a simple span, compression is always focused on the top flange while the bottom flange is always in tension. On continuous spans, areas under tension change as the steel crosses over intermediate supports (Figure 5-12).

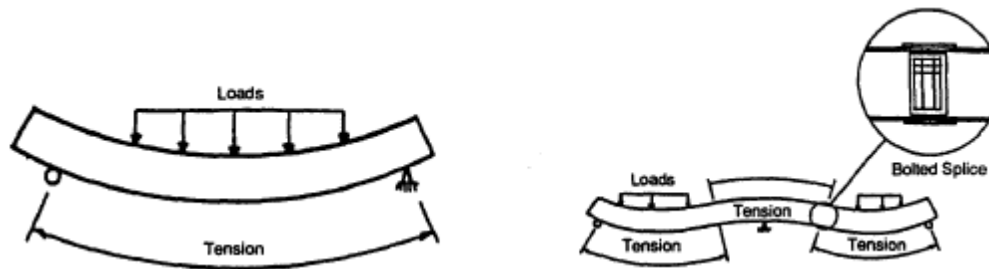

Figure 5-12 Simple Span (left) and Continuous Span (right) Beams

Technicians are required to be aware of areas in tension because that is where a beam or girder is most likely to fail if the beam or girder becomes damaged. Also, because heat may change the character of the steel and weaken the steel, welding and cutting of structural steel may be done only where specified or approved. No welding may be done for any reason on a flange or any other area that is or will be in tension.

FABRICATION AND ERECTION DRAWINGS

The Contractor is required to submit working drawings that indicate, in detail, the plans for fabricating and erecting structural members that meet the requirements of the contract drawings. The fabrication and erection plans are reviewed by the Division of Bridges for design features only. Even if the plans are approved, the Contractor is responsible for the dimension, accuracy, and fit of the work.

If the method of lifting the structural member in the field differs from the method shown on the beam fabrication working drawings, the Contractor must submit working drawings and calculations for the alternate method prior to lifting, in accordance with the Standard Specifications.

The fabrication and erection plans are required to indicate a plan for match marking all reamed pieces, such as diaphragms and splice plates. Match marks help the Contractor prevent misfits by ensuring the pieces are assembled in the field in the same manner as they were fabricated in the shop.

DELIVERY AND STORAGE

The structural steel members are inspected at the fabrication shop and are released for shipment by the fabrication inspector. At this point the structural steel has had a thorough inspection and should meet the contract requirements for material type and dimensions.

When the structural steel arrives on the contract, the Technician is required to inspect each beam or girder for damage. Additional inspections include:

1. Obvious defects or damage (nicks, cracks, bends), especially damage to the tension flange. Such damage is likely to worsen once additional loads are applied to the member

2. To minimize damage from handling, structural members are required to be stored as close as possible to the site where they are used
3. Structural members are required to be stored upright and off the ground and supported at all points of bearing to prevent unnecessary deflection. Members are required to also be adequately braced to prevent them from tipping over
4. All members and connecting pieces are required to be identified by match marks
5. Approved fasteners are required to be kept together and protected from the weather by keeping them from freezing, dust, and water in sealed containers prior to their use in the structure

ERECTION OF STEEL MEMBERS

Erection of the structural steel may begin only after the locations and the elevations of the bearing devices have been checked. During the erection process, the Technician is required to observe how well steel members line up with the bearing devices. Bearing elevations may be adjusted with shims as specified on the plans. Any adjustments to alignment are required to be approved by the PEMS.

Erection of the steel normally begins at the end of fixed bearing. Steel members are required to be placed in the order and in the locations according to the match marks indicated on the Contractor's erection plans. Although one member may look the same as the next, there may be virtually indiscernible differences in degrees of camber and other dimensions.

As soon as possible after setting adjacent girders, the Contractor is required to install enough diaphragms or cross-braces to secure the steel against the wind and to prevent the steel from being knocked over or falling over. (A steel beam or girder inherently wants to lay over on its side.)

The Contractor may use drift pins to line up holes between the steel and diaphragms and splice plates if the pins are used only to draw the parts into position. Drift pins may not be used to enlarge holes or to distort the metal.

Elevations of the splice joints are required to be established before permanent connections are made.

The Specifications state that the Contractor is required to use at least 50% of the bolts necessary to secure diaphragms and splice plates to the steel members. At this stage of the operation, the bolts may not be tightened to more than a snug tight condition. The Specifications define snug tight as the tightness attained after a few impacts of an impact wrench (Figure 5-13) or after the full effort of a person using an ordinary spud wrench. Final tightening of all bolts is delayed until all structural steel is in position.



Figure 5-13 Impact Wrench

In general, bolts are required to be tightened at the nut while the head of the bolt is prevented from turning. Field conditions, however, may require tightening some bolts at the head. Washers are required to always go under the part that is turned, whether that is the nut or the bolt head.

For aesthetic reasons, bolts that are used to secure splice plates to the web section of exterior or fascia members are required to be installed with the head of the bolt on the outside face to present a neater appearance, as seen in Figure 5-14.

Once the preliminary bolting has been completed, the Contractor is required to complete all connections. When possible, workers are required to start tightening the bolts in the center of a splice plate first and work out toward the edges. This procedure helps bring the plate into full contact with the structural member.



Figure 5-14 Splice Plate Bolts

FINAL BOLT TENSION

Bolts in splices and diaphragms are required to be tightened to a minimum tension according to the size of the bolt. The following table from Section 711.65 indicates the minimum bolt tension in pounds for a variety of bolt sizes. Again, only high-strength fasteners may be used.

Table 5-1 Bolt Tensions

The two methods of bolt tightening that may be used to achieve the correct bolt tension as specified are the calibrated wrench tightening and turn-of-nut tightening methods. Installation of all high strength bolts is done in accordance with the AASHTO LRFD Bridge Construction Specification requirements.

It is paramount that the fasteners be free from rust, dust, dirt, and other debris, and have a light coating of lubricant. Rust, dust, dirt, or other debris adds friction to the connection and bolts in this condition that are subsequently tightened will likely result in failure by yielding of the steel before the minimum bolt tension has been reached.

Once a high strength bolt has been tightened using an impact wrench and for whatever reason it is loosened, it must be removed. In general, high strength bolts may not be re-tensioned without permission from the PEMS.

CALIBRATED WRENCH TIGHTENING

The calibrated wrench tightening method requires using a power or manual wrench that is not only capable of tightening the bolts to the specified tension, but also capable of indicating when that tension has been achieved.

The wrenches that are used in this method are required to be calibrated once a day during the final tightening operations. Calibration of the wrenches requires tightening at least 3 bolts of each size represented in the structure in a device that can indicate actual bolt tension. The Contractor is required to inform the PEMS of when the calibration is going to take place so that INDOT may witness the procedure. The calibrated wrenches are required to be set to induce a bolt tension that is 5 to 10 % more than the specified tension.

Bolt Tension for ASTM F3125, Grade A325 Bolts	
Bolt Size	Minimum Bolt Tension,* pounds
1/2"	12,050
5/8"	19,200
3/4"	28,400
7/8"	39,250
1"	51,500
1 1/8"	56,450
1 1/4"	71,700
1 3/8"	85,450
1 1/2"	104,000

* Equal to the proof load (length measurement method) given in ASTM F3125

Table 5-15 Bolt Tensions

Power wrenches may be set to stall or cut out when the selected tension is achieved. The wrench is required to be capable of reaching the desired tension within 10 seconds.

If manual torque wrenches are used, the torque indication corresponding to the calibration tension is noted and used in the installation of all high strength bolts.

The Contractor is required to check all the bolts that were installed to the snug-tight condition during the erection of structural steel members. These bolts may have become loose due to the final tightening of the other bolts. It is acceptable to continue to tighten these bolts until the required tension is achieved.

TURN-OF-NUT TIGHTENING

The turn-of-nut tightening method of bolt tensioning requires all bolts be installed and brought to a snug condition before final tightening takes place. Final tightening is done by turning the nut or the bolt head a fraction of a turn beyond snug tight – 1/2 turn for bolts 8" long or 8 diameters or less, 2/3 turn for bolt lengths exceeding 8" or 8 diameters, and 3/4 turn for all bolts used to connect sloping pieces. For splice plates and diaphragms, the typical requirement is 1/2 turn from the snug tight condition (Figure 5-16), per Section 711.65(d)4.

INSPECTION

Whatever method the Contractor uses to achieve the specified bolt tension, the installation and tightening of bolts is required

Disposition of Outer Faces of Bolted Parts		
Both faces normal to bolt axis, or one face normal to axis and other face sloped ⁽³⁾ (bevel washer not used).		Both faces sloped ⁽³⁾ from normal to bolt axis (bevel washers not used)
Bolt length ⁽⁴⁾ not exceeding 8 diameters or 8".	Bolt length ⁽⁴⁾ exceeding 8 diameters or 8".	For all lengths of bolts.
1/2 turn	2/3 turn	3/4 turn

- (1) For coarse thread heavy hexagon structural bolts of all sizes and lengths and heavy hexagon semi-finished nuts.
- (2) Nut rotation is rotation relative to bolt regardless of the element (nut or bolt) being turned. Tolerance on rotation: 1/8 of a turn over and nothing under.
- (3) Slope 1:20 maximum.
- (4) Bolt length is measured from underside of head to extreme, end of point.

Figure 5-16 Nut Rotation from Snug Tight

to be observed to determine that all bolts are tightened properly according to the chosen method.

Because the Technician cannot observe the tightening of every bolt in the structure, the Specifications require the random inspection of at least 10 % of the bolts in each splice or other joint. In no case may the number of bolts to be inspected in any location be fewer than two.

If the inspecting wrench cannot turn a bolt head or nut in the tightening direction at the job-inspecting torque (the average torque needed to turn the three bolts in the calibrating device five degrees, plus 5-10 %), then the connection is accepted. If any bolt head or nut in the sample is turned by the application of the inspecting wrench at the job-inspecting torque, then all bolts in the connection are required to be tested. All bolts failing to meet the specified tension are required to be retightened and retested.

FINAL ADJUSTMENTS TO BEARINGS (END-OWE)

After all structural steel has been placed and bolted, the Contractor is required to adjust the steel longitudinally so that the distance from the backwall or mudwall to the centerlines of bearings on the abutments or end bents is equal on both sides of the structure. This operation is often referred to as end-owed (some adjustment is owed to the ends of the steel).

Once the longitudinal adjustments have been made, the anchor bolts in the fixed bearings may be grouted. Finally, after the grout in the fixed bearings has set, the Contractor may adjust the expansion bearings for temperature, then set the anchor bolts there as well.

This procedure is not performed on elastomeric bearing pads.

FIELD WELDING

As previously stated, field welding of structural steel may only be conducted where specified on the plans or otherwise approved. Improper welding may create many problems up to and including structural steel failure.

CERTIFICATION OF WELDERS AND MATERIALS

Section **711.32** provides information regarding welding in the field. All welding on INDOT contracts is required to be done by certified welders who use approved materials. The PEMS is required to retain a photocopy of the field welder's certification for the contract file. Some welders have been certified by AWS and carry a wallet card. However, it is more common for a welder to have performed a test weld in the presence of a certified weld inspector who subsequently has certified that this individual can produce a quality weld for the type of weld required for the work.

Welding materials, specifically rods or electrodes, are required to also be approved. If there is any doubt of whether a particular size, type, or brand of electrode is approved, the Technician is required to consult with the PEMS before allowing welding to proceed or to continue with the use of that material.

FILLET WELDS

Welding in the field is not common. When it does occur, Fillet welds are the most common type of field weld used. They have a triangular cross section and are used to join two surfaces

approximately at right angles to each other in a lap joint, a T-joint, or a corner joint. When welding is done, Technicians in the field are required to rely on visual inspection of welds. Items that are required to be inspected include the location of the weld, the size of the weld, and whether the slag has been removed. In general, a good weld will appear like a roll of dimes laid on its side and slightly angled.

MEASUREMENT AND PAYMENT

Structural steel is commonly paid for on a lump sum basis. Thus, no measurement is needed. Occasionally a contract will use a pay unit of pounds. When this occurs, the Technician must collect the delivery tickets for all the structural steel and hardware in order to validate the total weight provided by the Contractor.

CONCRETE MEMBERS

Concrete members, such as I-beams, box beams, and bulb T beams are used as alternatives to structural steel in many bridge superstructures. When constructed and erected properly, they may provide years of service.

Precast concrete beams (Figure 5-17) are made by a certified precast producer by pouring concrete into metal forms and allowing the concrete to harden until the concrete achieves a specified compressive strength.

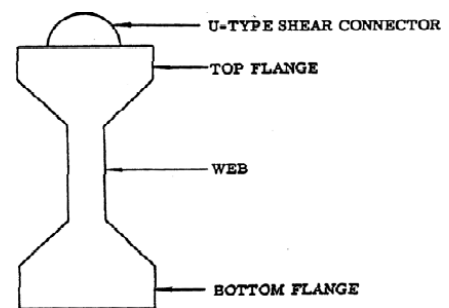

Figure 5-17 Precast Beam

Concrete beams may also be prestressed (Figure 5-18). Prestressing concrete requires stringing steel strands in layers through the beam forms and embedding them in the concrete. Most of the strands are concentrated in the lower part of the beam, where tensile stresses are usually the greatest. Precast prestressed beams are made by a certified precast prestressed producer.

The construction requirements for concrete beams are outlined in Section **707**. The certified precast prestressed fabricator produces the beams in accordance with these Specifications and to the sizes and dimensions indicated on the contract drawings. The fabrication plans and the Contractor's erection drawings are required to be approved, just as they are for steel beam construction. The materials and methods used in the construction of concrete beams are the responsibility of the plant inspector. Just like with structural steel, the field Technician's responsibility begins when the beams arrive at the contract site.

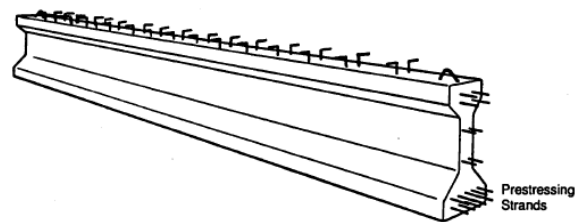

Figure 5-18 Prestressed Beam

DELIVERY, STORAGE, AND HANDLING

Prior to the delivery of the concrete members, the Technician is required to review the following references:

1. Applicable Special Provisions and Standard Drawings
2. Sections **707.08-11**
3. Check the Approved Materials list to ensure the concrete beams have been approved.

When the concrete beams arrive on the jobsite, yellow inspection cards may or may not accompany each member. These yellow inspection cards or other paperwork delivered with the beam shows that the beam has been inspected at the Producer's plant and was acceptable at the time it left the plant.

Concrete beams require the same careful handling and storage as steel members. Beams are required to be stored upright and supported off the ground. The supports are required to be level and located at the centerlines of bearing of the beam. This procedure reduces internal stresses that may cause unnecessary twisting or deflection.

The Technician is required to check all beams for cracking, spalling, and other damage to the concrete. Small hairline cracks are usually due to shrinkage and are not critical to the strength of the beam. Large cracks indicate mishandling. A beam that has been dropped, or one that has had something dropped on the beam, may have been weakened structurally. The PEMS is required to be made aware of any significant damage to the concrete members.

Like steel members, concrete beams use shear connectors to tie the beams to the concrete deck. The connectors, typically bent reinforcing bars, are required to be clean, free of rust, and bent only as shown on the plans.

The fabricator may have also located lifting hooks on the top side of the beams (Figure 5-19). The hooks are required to conform to the design and placement of the plans. Beams are required to be picked up at these points only. The pick-up cable is required to be long enough so that the cable may maintain a safe slope. $1\frac{1}{2}$ to 1 is a safe minimum. A flatter slope may produce enough stress on the tension (bottom) flange to weaken the beam. The Specifications allow the use of other methods of lifting if the procedures are in accordance with the recommendations of the beam fabricator. The recommended lifting methods are noted on the fabricator's plans.

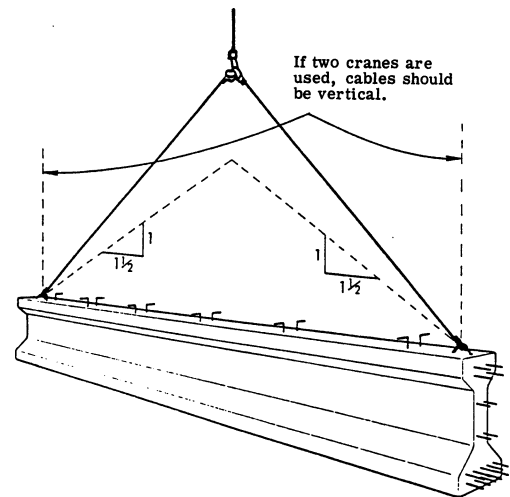

Figure 5-19 Lifting Hooks

ERECTING CONCRETE BEAMS

During the erection of concrete beams, the Technician's major responsibilities require observing that the erection plans are followed, and that each member is set in the proper location. The beams are required to be match marked to locations indicated on the plans.

The members are required to be erected in the sequence shown on the plans. Ends of fixed bearings are typically installed first. All adjustments are required to be made while the beams are supported by the lifting devices, not when they are resting on the bridge seats. The Contractor is not allowed to use pinch or crow bars to move the beams because they may chip and damage the concrete. If the beams were constructed correctly and the substructure units are properly aligned, only minor adjustments are needed to get the beams seated on the bearing areas.

SECURING BEAMS TO BEARING AREAS

Concrete beams are required to make full contact with the bearing areas. They may be secured to the bearing areas with dowel bars that are inserted through precast holes that extend through the beams and down into holes in the bridge seats. These holes are filled with grout at the fixed ends of beams and with flexible joint filler at the expansion ends. Some beams may be secured to the bearings by plates or angles that have been cast into the sides or bottoms of the beams.

DIAPHRAGMS

Like steel beams, concrete beams typically require diaphragms to provide the beams with lateral support. Diaphragms for beams are required to be formed to the dimensions shown on the plans and may be cast in place or may be steel diaphragms. They are not precast like the beams they connect. The reinforcing bars for diaphragms are inserted into the holes that have been cast partway through the inside web section of fascia beams and all the way through the web section of interior beams. The plans may require reinforcing bars to be installed as soon as adjacent beams are placed. Forming and pouring some of the diaphragms takes place after the erection of the beams and before the deck forms are installed. Other diaphragms, typically diaphragms over interior bents or piers are poured with the deck as shown on the plans.

FINAL APPROVAL OF CONCRETE MEMBERS

The Contractor is not allowed to grout dowels or anchor bolts, construct forms, or pour concrete for any diaphragms or for the bridge deck until the PEMS has received complete documentation of the acceptability of the concrete members and bearing pads, including satisfactory lab results and material certifications.

MEASUREMENT AND PAYMENT

Precast or precast prestressed structural members are measured by the linear foot measure. Payment for concrete structural members is to be made at the contract unit price per foot, completed in place. If the Contractor is to be paid a lump sum price for the members, then no measurement is necessary.

The cost for the reinforcing bars, bearings, and other incidental items necessary to complete the work is included in the cost of the structural members.

CHAPTER SIX: *BRIDGE DECKS*

REFERENCES

Many of the requirements for bridge deck construction are contained in Section **704**, Concrete Floor Slabs.

Technicians are required to also refer to the INDOT Standard Drawings for bridges, and for a specific contract, they are required to become familiar with the superstructure detail sheets and any Special Provisions associated with that contract.

GRADE CONTROL

Establishing accurate grade controls for a bridge deck is essential for both ride quality and structural integrity. Errors in the grade controls mean an uneven surface with too much concrete cover in one area or too little cover in another. Although most of the computations required for establishing grade controls for bridges are conducted by the Contractor, the Technician is required to know how to interpret these computations to ensure the deck has uniform thickness and provides adequate concrete cover over the deck reinforcement.

SCREED ELEVATIONS

After the erection of the structural members and the tightening of all bolts, the Contractor obtains and records elevations at predetermined grade control points along each girder of each

span in the structure (Figure 6-1). Averages may not be used.



Figure 6-1 Girder Elevations

The grade control points are typically located at regular intervals on the members, such as every 10 ft or at some fraction of the span length such as every $\frac{1}{8}$ point. The plans or the PEMS specify the intervals or locations of the grade control points. Typically, the elevations are taken by the Contractor. A copy of the elevations must be furnished to the PEMS and forwarded to the designer of record so they may verify some design assumptions and provide correct screed elevations.

The next step for the Contractor is to subtract these field elevations from the theoretical screed elevations for the same points as shown on the plans or furnished by INDOT. The theoretical screed elevations consider the planned deck thickness, the rate of cross-slope, and the amount of deflection that occurs at the control points when the concrete is placed. The planned deck thickness, cross-slope, and amount of deflection are indicated on the superstructure detail sheets in the plans.

The difference between the screed elevations and the field elevations at the control points equals the distance between the top of the beam and the top of the deck. In other words, the difference between the screed elevation and the field elevation equals the slab thickness at that point.

The distance between the top of the beam and the screed elevation is typically marked on the top of the beam in inches and circled (Figure 6-2). The screed of the finishing machine will be set to pass above that point at the indicated distance. If the beams or girders have been accurately cambered and properly set, the slab thickness should equal the thickness specified on the plans. Variations from the planned thickness usually indicate deviations in the camber of the beam or girder. The Contractor may make up for some minor deviations when the deck forms are installed.

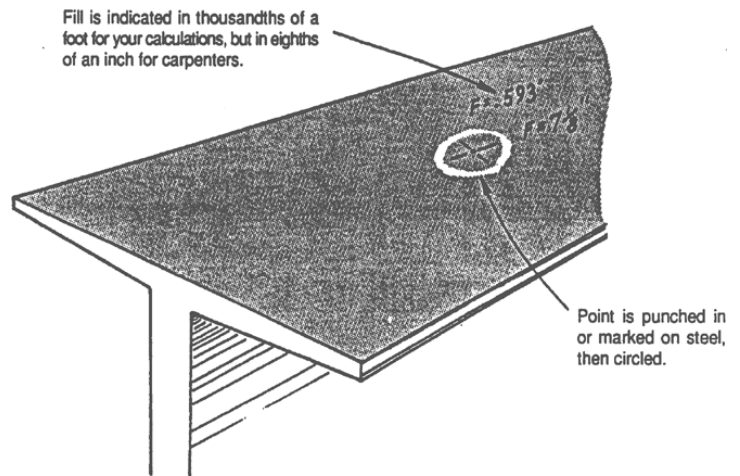

Figure 6-2 Beam Measurements

DECK FORMS

Forms for bridge decks support the concrete between adjacent structural members until the concrete hardens. To a large degree, the placement of the deck forms controls the slab thickness. Like formwork for substructure units, deck forms are required to be mortar tight and sufficiently rigid to support the concrete without distorting under the load.

APPROVAL OF FALSEWORK PLANS

The Contractor is required to submit falsework plans to INDOT for review. These plans indicate how the Contractor plans to support the forms so that they produce the slab thickness and grades shown on the plans. Any falsework or forms installed before these plans are reviewed is done at the risk of the Contractor.

TYPES OF DECK FORMS

Deck forms are either removable or permanent. Most removable forms are made of wood. Permanent forms are made of metal.

Removable wood forms (Figure 6-3) typically consist of $\frac{3}{4}$ " exterior-grade plywood sheets for the flooring supported by wood joists and stringers and adjustable metal brackets and hangers. These forms are used with all types of structural members. Wood form materials do not require specific approval or certification; however, the Technician is required to make sure the materials are clean, straight, and in reasonably good shape. Joints are required to be filled to prevent concrete leakage. Form faces that come into contact with

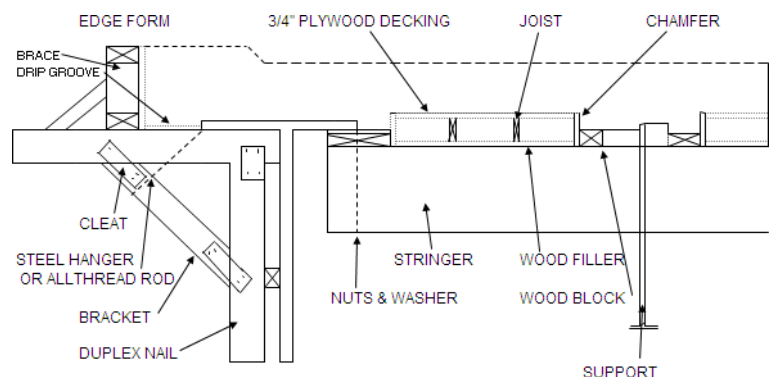

Figure 6-3 Wood Forms

plastic concrete are required to be coated with an approved formulated form coating material, so they remove easily and do not mar the concrete surface.

Permanent metal forms (Figure 6-4) come in panels of corrugated steel. When steel beams or girders are used as structural members, the panels are supported by metal angles that are



Figure 6-4 Metal Forms

welded or strapped to the top flange depending on whether that portion of the top flange is subject to tensile stresses. The form panels are not allowed to rest directly on the structural steel itself.

When prestressed concrete bulb-T, I-beams, or box beams are used, permanent metal forms are supported by adjustable straps or hangers or by steel inserts cast into the top flange. No form support may be welded to the reinforcement extending from a concrete beam.

INSTALLING DECK FORMS

The Technician is required to verify that the forms (Figure 6-5) are installed in such a way that they produce the required slab thickness and cross-slope at every point along the surface of the deck. The Contractor is required to follow the requirements of the contract drawings and the specifications. The purpose for the use of the formwork is to provide a correct and uniformly consistent deck thickness.

The Contractor installs the deck forms according to the figures marked at the grade points on top of the beams and the degree of cross-slope per foot as specified on the plans. For example, if the mark on the beam is $8\frac{3}{4}$ " and the planned thickness of the slab is 8", the Contractor knows the floor of the deck forms is required to be set $\frac{3}{4}$ "



Figure 6-5 Deck Form Installation

higher than the top of the beam. On the other hand, if the mark on the beam is $7\frac{1}{4}$ ", the forms would be set $\frac{3}{4}$ " lower than the top of the beam. When working away from the crown, the Contractor is required to add into his calculations the degree of cross-slope. When working toward the crown the Contractor is required to subtract from the calculations the degree of cross-slope. The cross-slope may be maintained and checked for accuracy with a stringline or a level.

During the installation of metal deck forms, the Technician is required to ensure that support angles are not welded onto flanges of steel beams or girders that are in tension. On simple spans, the bottom flange is the tension flange. The plans indicate which areas are in tension and which are in compression for continuous spans.

To prevent the loss of mortar through the joints, metal deck forms are required to be overlapped and installed in the opposite direction of the direction of the concrete pour. Panels are required to be secured as soon as they are placed to prevent the panels from being blown off by the wind.

INSTALLATION OF SHEAR CONNECTORS

Steel beams and girders often have shear connector studs welded to the top flange in the field (Figure 6-6), typically with a stud welding gun. The size and spacing of the studs is specified on the plans and may not be changed without the approval of the PEMS.



Figure 6-6 Shear Connector Studs

The Technician is required to inspect three items for the installation of the shear connectors:

1. The site of the weld is clean and smooth
2. The weld is complete around the base of the stud
3. The studs are spaced according to the plans

Several of the welded shear connectors are required to be tested by bending them to an angle of at least 15 degrees with a hammer. If the weld holds for the studs sampled, the remaining connectors on that beam may be accepted.

DECK REINFORCEMENT

Inspecting deck reinforcement is no different from inspecting the reinforcement for any other part of the structure. The main concerns are:

1. The correct sizes and types of bars are placed in the correct locations
2. All bars listed in the plans are used and there are no leftovers
3. The correct bar spacing is maintained
4. Bars are checked for the proper amount of clearance from the deck forms and for proper amount of concrete cover
5. All bars are securely tied to prevent displacement. The top mat is required to be tied down to the bottom mat or the deck forms to prevent floating during the pour
6. Trussed sections of trussed bars are centered over beams
7. All splices are correctly lapped

To ensure the above-noted concerns are addressed, the Contractor must double check the accuracy of the deck form installation before placing the reinforcing bars. Once the reinforcement is in place, adjustments to the forms are difficult and time consuming.

The Technician should check the clearance between the bottom layer of reinforcement and the deck forms (Figure 6-7). Typical clearance is 1". Approved chairs may be used to obtain and



Figure 6-7 Checking Reinforcing Bar Clearance

maintain the clearance from the forms. The Technician must also check the positions of expansion joints and drainage features. These items are required to be correctly placed at the planned slab thickness and grade.

ADJUSTING THE SCREED RAILS

When the concrete for the deck is placed, the Contractor uses a deck finishing machine (Figure 6-8) to strike the concrete off at the correct elevation. Although there are several types of finishing machines, they all have the following features in common:

1. They ride on tracks or rails that are set on top or outside of the forms for the copings or barrier rails
2. They have adjustable screeds that may be set to different crowns or elevations. Many finishing machines also have augers that help consolidate the concrete before the concrete is struck off by the screed
3. They have guide tracks from which the screed and auger are suspended

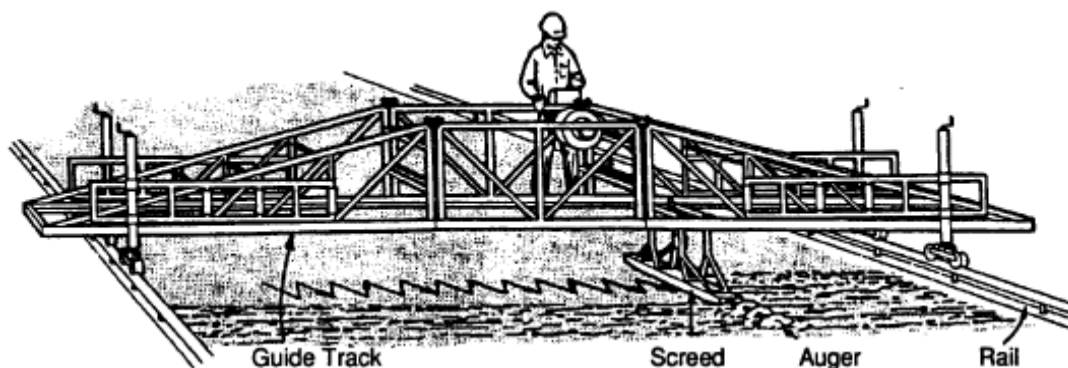

Figure 6-8 Deck Finishing Machine

The Contractor is required to adjust the screed rails so that the screed of the finishing machine passes over the control points on the beams at the screed elevations indicated on the plans. Different contractors use different methods; however, all methods measure up from the control points and consider the rate of cross-slope from one side of the bridge to the other.

After the initial adjustment of the screed rails, the Contractor makes several dry test runs with the finishing machine to check the actual screed elevations above the deck forms and the control points on the beams. The dry run is conducted back and forth and side to side over the entire bridge. The Technician is required to take measurements at random locations from the deck forms up to the screed (Figure 6-9). The measurements are required to equal the planned deck thickness at these points.

A good practice is to take measurements on both sides of every beam flange, but not over the beams, as the finishing machine travels transversely across the deck. As measurements are noted, the finishing machine should only advance longitudinally along the deck approximately 10 ft or $\frac{1}{10}$ of the span length before another set of measurements are taken.

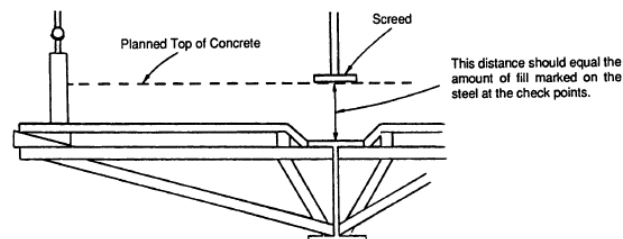

Figure 6-9 Planned Deck Thickness

The amount of concrete cover over the top mat of reinforcement is required to be checked during the dry run. Measuring up from the top of the reinforcement to the screed indicates the amount of cover. The coverage is shown on the plans and is typically 2 ½" of concrete. The General Notes section or the plans provide the specific requirements for each structure.

Particular attention is required to be paid to the elevations of the ends of the bridge and the expansion joints. The screed is required to strike the concrete off at the same grade as the joints so there is a smooth transition from the roadway over the joint and onto the deck.

During the trial run, the Technician should watch the screed rails for deflection. The rails must be supported at close enough intervals to prevent sagging which distorts the profile grade.

CONCRETE PLACEMENT

After the adjustments of the screed rails and final checks of the reinforcing bars, the Contractor notifies the PEMS that everything is ready for concrete placement.

A great deal of work has gone into a new bridge by the time the "deck pour" takes place, but the deck gets particular attention, as it is the portion of the bridge with which the traveling public will make contact. As such, smoothness and durability are important.

The day before the pour, make final checks for accuracy of reinforcement placement (proper number of bars, epoxy coating is not damaged, etc.), form soundness, properly placed chamfers and drip edges on copings (outer overhangs), no gaps in the SIP's (Stay-in-place metal deck forms, also commonly called "pans"), etc. Details are important.

PRE-POUR CONFERENCE

All contract personnel who are involved with the deck pour should attend the pre-pour conference with the PEMS and representatives of the Contractor. Among the topics to be discussed are:

1. The class of concrete required on the plans. Most deck concrete is class C concrete
2. The slump and air content requirements, including the frequency of field tests
3. The pour sequence. The pour sequence and procedure is to be submitted at least 14 days prior to the planned deck pour. Longer bridges often must be poured in sections. The Contractor and the Technician are required to know which sections are to be poured first and where to locate the necessary construction joints
4. The quantity of concrete needed. This information is available from the Bill of Materials section on the superstructure details sheets
5. The rate of delivery (Section **704.04**). This is a very critical item. A slowdown in delivery means the formation of a cold joint. A cold joint is an area where fresh concrete is poured up against concrete that has begun to set, without the benefit of a construction joint. Steps to install emergency bulkheads are required to be discussed
6. The weather forecast and what kinds of precautions are required to be taken against excessive heat, cold, wind, or the threat of rain
7. The Contractor's manpower and equipment. Enough skilled workers to produce the required deck thickness and finish are required. Backup vibrators are required to be available and curing materials are required to be on hand
8. Finishing, tining, and curing are also worth discussing

Once all these items have been discussed and resolved, the Contractor is ready to begin concrete placement. For the most part, the inspection concerns during the placement of concrete for a bridge deck are the same as those noted for other parts of the bridge.

PREPARATION OF THE FORMS

Standing water and construction debris are required to be removed from all forms before beginning concrete placement. Removable forms that come into contact with plastic concrete are required to be coated with a formulated form coating material to prevent adhesion.

CONCRETE PLACEMENT AND CONSOLIDATION

The Contractor typically will use a concrete pump to move the fresh concrete from the delivery trucks to the point of placement on the deck. Ready-mix concrete trucks pull up and discharge into a pump truck. Generally, concrete with slump lower than about 3" can't be easily pumped. Consequently, the Contractor has an incentive to increase the slump – potentially beyond specification limitations. The Technician should keep this possibility in mind when observing the physical properties of the concrete. Consult the Frequency Manual for the type and number of tests necessary for the pour, but understand, a Technician is free to take additional tests whenever it is deemed necessary.

It is recommended that the Technician sample the fresh concrete from the point of placement – after pumping and before vibration – and remove it from the bridge to perform the necessary testing. This can be done by putting down wood planking or plywood on top of the reinforcing mat and rolling a wheelbarrow to and from the pump hose location where the fresh mix is being placed. The planking makes use of the wheelbarrow easier, but it also performs the important function of protecting the epoxy coating on the reinforcement from being marred by equipment. The Contractor might also use this planking for moving generators (to run vibrators) and for "slick line" to use as part of their pumping system.

Laborers tend to clean off their masonry hoes or *come-alongs*, rake-like tools for moving concrete, by striking the reinforcing mat. This must be discouraged as it damages the epoxy coating. Another common error is to use the vibrator(s) to drag or walk the fresh mix across the deck. Instead, the laborer operating the hose end of the pump should use more care to place it where needed.



Figure 6-10 Concrete Vibrating and Striking Off

Concrete for decks is required to be placed as close as possible to the area the concrete occupies in the structure. The concrete is required to be placed evenly across the deck from a drop height of no more than 5 ft.

The concrete is required to be consolidated with a vibrator as the concrete is placed (Figure 6-10). Good consolidation techniques include vertical insertion and withdrawal of the vibrator quickly to avoid segregation. A soupy mix may indicate over-vibration of the concrete.

When pouring near expansion joints, the concrete is required to be placed up under the top plate of the joint. The Technician is required to be able to observe mix coming up through any vent holes on the plate. Tapping the joint with a hammer and listening for hollow sounds that indicate voids is a good practice.

When plastic concrete is placed against a previously poured section at a construction joint, the face of the joint is required to be coated with an approved epoxy mixture (Section **702.20(a)**) to enhance the bond of the old mix to the new. The type of joint construction, unless the joint is an emergency bulkhead, is noted on the plans.

FINISHING OPERATIONS

The concrete pour must not get too far ahead of the finishing machine, as the mix may begin setting up before the concrete is struck off by the screed. The operator is required to move the finishing machine ahead only about 6" for every pass across the deck. This procedure ensures every square inch of the concrete surface is struck off.

Ideally, a thin bead of concrete rolls directly ahead of the roller screed, indicating that the screed is striking off the mix at the right elevation and filling in low spots as the screed moves along. If the bead gets too large, however, the screed could lift up over the concrete. Before this happens, the bead is required to be pulled back with shovels or masonry hoes. Rakes are not allowed because they may cause segregation.

As soon as the screed passes, workers may begin applying the initial finish (Figure 6-11). Typically, this involves brooming, floating, or troweling the surface. This initial finish is done mainly to close the surface and to eliminate bumps and low spots that were left by the screed. The texture of the freshly finished surface is required to match up closely with that of any previously poured section.



Figure 6-11 Concrete Finishing

The deck surface is required to be checked with a lightweight 10 ft straightedge every two feet transversely and every 5 ft longitudinally. All high spots are required to be removed, all depressions are required to be filled with fresh concrete, and the surface is required to be leveled by a large float. Floating and manipulating the concrete to fill depressions is held to a minimum, as should the application of additional water to the concrete to lubricate the float surface.

CURING REQUIREMENTS

Bridge decks are normally cured in the same manner as other structural concrete components. Section **702.22** contains the procedures for the protective covering curing method. The curing method requiring the use of a curing compound on the deck is not used because this procedure prohibits the use of an epoxy surface seal, which protects the deck from salt penetration.

The curing period for decks is 168 hours after the concrete has taken the initial set. During this time, the deck is required to be kept covered with an approved protective covering such as

burlap or plastic or burlene and wetted at sufficient intervals to prevent premature drying. One problem area for curing is the copings where the vertical reinforcement extends above the deck concrete. Simply draping or tenting the covering over the reinforcement is not adequate since this procedure allows air to enter and dry the concrete. Instead, the Contractor is required to wind the covering through the reinforcement as well as possible to cover the concrete.

Finally, walking on a newly poured deck is discouraged. If walking on the deck is necessary, wood walkways supported by a cushion of burlap are required to be used.

QC/QA SUPERSTRUCTURE CONCRETE

Although not commonly used, QC/QA Superstructure Concrete Specifications require the proper allocation of responsibility for quality between the Contractor and INDOT, more complete records, and statistically based acceptance decisions. The Contractor has a greater choice of materials and may design the most economical mixtures to meet the specifications. Finally, there is a lot-by-lot acceptance so that the Contractor knows if the operations are producing an acceptable product. If the contract calls for QC/QA Superstructure Concrete, the Technician should read the contract special provisions to familiarize themselves with the necessary requirements.

CHAPTER SEVEN: *BRIDGE DECK REPAIR*

A major effort has been made in recent years to rebuild roadways and bridges that have been deteriorating at a faster rate than that for which they were originally designed. Where snow and ice are common through much of the winter, deicing materials have contributed significantly to this deterioration, particularly on concrete bridge surfaces. The result of this deterioration is cracking, scaling, and delamination of the concrete, corrosion of the reinforcing bars, and loss of bond between the concrete and reinforcing bars.

To aid in the rebuilding effort, many of Indiana's bridge decks being repaired are overlaid with new protective wearing surfaces.

This chapter discusses latex-modified portland cement concrete bridge deck overlays for existing bridge decks and patching of existing latex- modified concrete overlays. The work is covered by the plans, Standard Specifications, and Special Provisions.

The main steps in repairing bridge decks without a latex-modified overlay include:

1. Setting up traffic control, and other preparations
2. Scarifying or surface milling the deck
3. Locating and marking deteriorated areas
4. Removing unsound concrete and deteriorated reinforcement
5. Replacing expansion joints
6. Patching the deck
7. Calibrating the concrete-mobile mixer units
8. Blasting and cleaning the deck
9. Setting up the finishing machine, and final deck inspections
10. Placing, finishing, and curing the overlay
11. Inspecting the overlay after curing

Patching existing latex-modified concrete overlays follow similar preparations and work steps.

Primary concerns during deck repair are the safety of the workers and traveling public, preparation of the bridge deck, the storage and handling of materials, the calibration and operation of the various types of equipment, and the quality of work produced.

PREPARATIONS FOR DECK REPAIR

HMA WIDENING

HMA widening (Figure 7-1) is often required if the traffic lanes are to be restricted during the overlay operations. HMA is placed to provide additional pavement width for vehicle travel. While included here as a preparation, HMA placement is usually the first phase of construction on bridge deck overlay contracts.



Figure 7-1 HMA Widening

Areas that are to be widened are indicated on the plans along with the length, width, and depth. If 8" or more of HMA shoulder is in place, widening may be eliminated after consulting with the PEMS.

Before excavation begins, the areas to be widened are required to be sawcut to prevent damage to the existing pavement and shoulder. The saw-cutting also ensures a clean, straight edge that provides a neat-looking job.

During excavation, the depth is measured to ensure that the plan depth is being achieved. Also, the length and width of excavation is required to be verified at the same excavated area.

After the widening areas have been excavated to the correct dimensions, the bottom of the excavated area is required to be thoroughly compacted. Portions of the bottom of the excavated area that cannot be covered by rollers, such as at the ends, are required to be compacted by mechanical tampers.

All areas of trenches where new HMA widening meets the existing pavement or HMA shoulder are required to have tack coat applied prior to the paving operation. Tack is most often paid for by the square yard, so these areas are required to be measured and documented for payment and the final construction record.

The type of HMA mixture to use in widening areas is indicated on the plans. The placement of the mix is required to be in two or three lifts, with each lift being compacted after the HMA is placed.

TRAFFIC CONTROL

Traffic control plans are required to be reviewed by the Technician and revised, when necessary, when controls are first set up and when the work shifts from one phase to another.

For HMA widening operations, drums or cones are typically required for traffic control through the work zone. Following the construction of any required widening, temporary pavement marking edge lines may be placed. The location, type, and amount of temporary striping is shown on the plans. Measurements and notes are required to be taken of all pavement markings placed, because the Contractor is paid for this work by the linear foot.

Right after the placement of pavement striping, temporary traffic barriers, type 1 or 2 (whichever are specified on the plans) (Figure 7-2) are set in position following the plans. The barriers are placed to both guide the traffic and separate the traffic from the work area. The plans indicate the intended locations of barrier sections, information on the open lane width from curb to barrier, width of work area closed to traffic, number of sections required at the tapered end, the rate of the taper, whether a crash-attenuator end section is required, and the total length of barrier required.



Figure 7-2 Temporary Traffic Barriers

Barrier placement is required to start with the tapered area and move across the deck in the direction of traffic flow. As the barrier sections are installed, the drums or cones may be

removed. The barrier sections are typically locked together. Delineators and type C lights are required to be attached to the barriers (Section **801.10(d)**) depending on the type and function of the barrier.

Once the placement of the barriers is complete, the total length is required to be measured and documented, noting the lengths of straight runs and tapered areas. (The specifications should be checked carefully as sometimes the CZ unit is not paid separately, but rather included in the cost of the barrier.) The Contractor is paid by the foot for this measurement only once. There is no additional payment when the barrier sections are later moved for work on the other side of the deck or subsequent phases of the contract.

Construction time for the deck repair is limited. Therefore, little time may be lost between the different phases of work. Surface milling (or scarifying) is usually done right after the barriers are set. This means that the deck is required to be sounded not long after the barriers are in place. At this time, all necessary arrangements are required to be made for help to sound the deck if the deck size or conditions warrant more help. Also, enough spray paint, chains, and any other sounding equipment or materials are required to be furnished by the Contractor to complete the original soundings of the deck.

SURFACE MILLING (OR SCARIFICATION)

Following HMA widening and installing temporary traffic barriers for traffic control, the first work to be done on the bridge deck is to prepare the deck for the concrete overlay. The steps required for this preparation are:

1. Surface milling or scarifying the entire bridge deck or floor
2. Locating the deteriorated areas, typically by dragging a chain across the deck
3. Removing unsound concrete
4. Sandblasting or water blasting the deck
5. Cleaning all dust and chips from the surface with compressed air

PURPOSE

Surface milling, or scarifying, (Figure 7-3) is required if the overlay is to be placed on a deck that was constructed under a previous contract. If not shown on the plans, the Specifications (Section **722.06**) indicate the required depth of surface milling.



Figure 7-3 Deck Surface Milling/Scarifying Machine

The two main purposes for this are:

1. To provide a clean concrete surface for the overlay concrete to bond with. Surface milling removes surface contaminants such as oil, rubber, epoxy, and other foreign substances that prevent the latex-modified concrete from adhering to the prepared surface
2. To remove deteriorated areas or decrease their size. Not all the unsound concrete is removed by milling the surface. Surface milling provides a head start for the eventual removal of deteriorated material

EQUIPMENT

The equipment used by the Contractor to do the surface milling is required to be a power-operated mechanical milling machine. There are different makes and models of these machines. Milling attachments may also be mounted on other equipment, such as motor graders. Regardless of the type of equipment used, the equipment is required to remove the deck surface uniformly to the required depth.

The milling machine scarifies the deck surface with dozens of teeth arranged in spiral fashion on a drum that revolves at high speed. The spiral arrangement of the teeth enables each pass of the machine to give complete, uniform scarification for the width covered.

The machine may be operable with either an up cutting or down cutting rotation. The direction of rotation used may affect the quality of the milled surface.

Some machines are equipped with a sprinkler system to apply water along the drum. Water not only helps to cool and lubricate the teeth, but also helps to reduce the dust produced by the milling. This dust pollutes the air and hinders the visibility of motorists driving through the work zone.

Because of the heavy wear they undergo, the milling teeth wear down rapidly and the Contractor is required to replace them often. Uneven milling which is evidenced by gouges, grooves, or ridges in the deck, may well be due to missing or worn teeth. Improper operating speed of the milling machine may also result in an unsatisfactory surface.

PROCEDURES

The surface milling operation is required to be limited to the part of the deck this is closed to traffic at any one time. The limits of surface milling are indicated on the plans. The area between the end of the bridge and where the pavement section begins is called the bridge approach slab. Usually this is removed and replaced. On rare occasions, it is scarified and overlaid.

Although milling machines are equipped to cut pavements by following a graded stringline, the surface milling of the deck surface may not be controlled by grades. Instead, the requirement is to remove a uniform depth from the entire deck surface. In areas of the bridge floor not accessible to the milling machine such as close to curb, gutter, and expansion dams, the removal is required to be done by hand-chipping or other acceptable method.

The milling machine operator usually cannot see the surface that has been scarified. Therefore, another crew member is required to frequently sweep off the chips and dust behind the machine to observe whether the coverage is complete and uniform.

Reinforcing bars that were originally set too high during deck construction may be hit and broken by the surface milling. These bars are required to be spliced. Usually, an undistributed quantity is set up in the contract to replace reinforcing bars cut by surface milling or otherwise deteriorated.

After the initial surface removal, an additional ¼" of surface milling may be required on part or all the deck, as directed by the PEMS.

Following surface milling, all residue from the milling, such as water, dust, and concrete, is required to be immediately and thoroughly removed from the bridge deck. The surface milling is not completed, for payment purposes, until the deck is thoroughly cleaned of all loose debris. As necessary, the Contractor is required to use a mobile vacuum, hand brooms, air compressors, or shovels, to complete the clean-up. Any spots where oil has penetrated below the milled surface are required to be chipped out.

MEASUREMENT AND PAYMENT

Surface Milling is a pay item, and the unit of measurement is the square yard. The total area to be paid includes all deck surface that has been properly scarified, whether by the milling machine or by hand-chipping. The payment the Contractor receives for surface milling includes payment for the cost of removing of all residues from the milling.

Where the PEMS directs additional surface removal beyond the initial depth, this work is also measured by the square yard.

LOCATING DETERIORATED AREAS OF DECK

After the deck is scarified and cleaned, all unsound concrete is required to be located and removed. While surface milling automatically removes some unsound concrete with the uniform ½" removal of the deck surface, the remainder of the deteriorated concrete is required to be removed. The Contractor is required to provide the equipment and materials to remove the deteriorated areas of the deck determined by INDOT.

Locating deteriorated areas of decks requires determining the exact limits of these areas to ensure that the full extent of unsound concrete is removed.

VISUAL INSPECTION

In many cases, deteriorated concrete may be seen or at least the signs that indicate the presence of the deterioration is seen.

Typically, a bridge floor badly in need of repair has several patches scattered about the surface. Some patches are broken out and obviously are required to be completely removed.

Other than those areas, all cracks, dark spots, loose or flaking concrete, and any unscarified parts of the deck must be located. Additionally, dark areas indicate wetness in the concrete that may have corroded reinforcing bars, and should be carefully inspected.

SOUNDING

Sounding is done to determine the unsound portions of the concrete to be removed. Deteriorated concrete may be detected audibly when a chain is dragged across the concrete, a steel rod is dropped on the concrete, or a hammer taps the concrete.

The entire deck is required to be sounded. The methods listed above are manual; however, there are also machines that may be used in detecting unsound concrete and delamination. Only the manual methods are discussed.

A chain being dragged over unsound concrete makes a distinct, hollow sound. Similarly, a dropped steel rod or tapping hammer produces a hollow sound on unsound concrete. Another good indicator of unsound concrete is dust particles that vibrate or jump on the deck surface when one of the tools is dragged, dropped, or tapped.

While the three sounding methods listed above are perhaps equally effective in revealing deteriorated concrete, the fastest of the three methods is chain-dragging. Tapping with a hammer and sounding with a rod are slow – these methods are generally better suited to sounding smaller areas and double-checking areas marked after sounding by chain.

All areas of unsound concrete in the deck, whether they are found by visual inspection or by sounding, are required to be located.

PROCEDURES FOR MARKING

As they are located, unsound areas are required to be accurately marked to include all the concrete to be removed to clearly guide the Contractor in the removal operation.

The marking is required to be done in two steps. First, the perimeter of each unsound area is lightly marked as the sounding is done. This results in a tentative outlining of the extent of each bad area as determined. The light marking is done by using dots or dashes to mark the perimeter. This is a trial-and-error marking at this point. One to two inches into sound concrete is required to be removed so that the overlay concrete bonds with sound concrete.

The second step begins once the perimeter of the unsound area is marked. Solid straight lines are used to indicate the unsound areas and the Contractor is required to remove everything within the lines. There should be no mistaking of boundaries or overlooking of areas to be removed.

After all areas have been sounded and unsound areas have been marked, the areas not marked are required to be double-checked. If no more bad spots are found, the initial sounding and markings are complete.

REMOVING DETERIORATED AREAS OF DECK

The next operation is the removal of the marked areas of the deck. Removal of unsound concrete is generally done by hydrodemolition. Hand chipping primarily occurs in areas inaccessible to the hydrodemolition equipment, or when more targeted demolition is needed.

HAND-CHIPPING

Hand-chipping tools may be hand-driven or mechanically driven. Mechanically driven hammers are used to remove all deteriorated concrete down to 1" from the reinforcing bars. The Specifications permit these tools to be no heavier than the nominal 45 lb class. Ninety-pound hammers may be used on reinforced concrete pavement, mudwalls, wingwalls, and the like, but never on bridge decks.

Mechanically driven tools are required to be operated at a maximum angle of 45° from the bridge surface. Tools operated any closer to the perpendicular may damage the sound portions of the deck by causing cracks or delamination.

Only hand-chipping tools may be used to remove concrete within 1" of the reinforcing bars and on down below the reinforcing bars. These hammers are required to be no heavier than the nominal 15 lb class.

When required, the workers are required to carefully remove the unsound concrete from around the reinforcing bars using only 15 lb hand-chipping tools from that point on down.

HYDRODEMOLITION

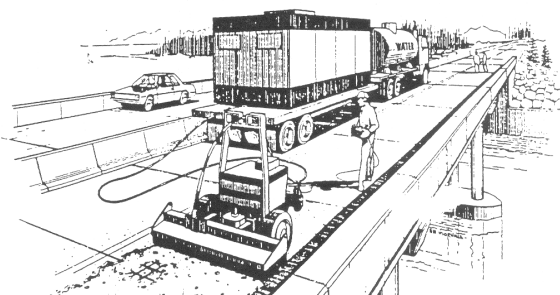

Figure 7-4 Hydrodemolition

Hydrodemolition equipment (Figure 7-4) uses an extremely high-pressure water jet system to break away the unsound concrete, without removing adjacent sound concrete. The water jet pressure is calibrated for each structure to ensure that only the unsound concrete is removed. Hydrodemolition equipment settings are required to be communicated to the PE/S in advance of use.

The object of the hydrodemolition is to remove all the unsound concrete and only the unsound concrete. The removal operation is required to stop if any sound concrete is being chipped out of the bridge deck. A jet of water under extremely high pressure (Figure 7-5) is used to break away the unsound concrete. If any sound concrete is removed, the Contractor is required to re-calibrate the equipment or otherwise change the equipment or work method before resuming removal operations.

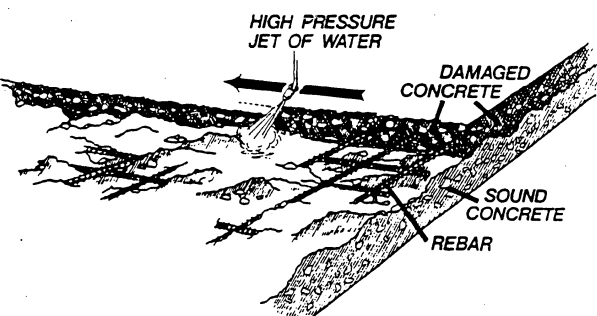

Figure 7-5 Hydrodemolition Process

The Specifications require that the water used in hydrodemolition be potable (drinkable). Stream or lake water is not allowed. The water is required to be from a municipal or other treated source. Also, the wastewater from the operation is not allowed to be discharged into a stream.

REINFORCING BARS

Where the bond between the concrete and the reinforcing bars has been destroyed, the concrete adjacent to the bars is required to be removed to a minimum clearance of 1" around the entire periphery of the exposed bar. Where the bond between the concrete and the reinforcing bars has not been compromised, concrete is not required to be removed from around the periphery of the bar. The Technician or PEMS determine whether the bond has been compromised.

Whether partially or completely exposed, the reinforcing bars may not be damaged by the removal of the concrete. If the reinforcing bars are damaged, the Contractor is required to repair the reinforcement, as directed, with no additional payment. The repair typically requires splicing, with the amount of bar overlap dependent on the bar size. The repair never involves welding.

PARTIAL-DEPTH AND FULL-DEPTH PATCHES

Removal of unsound concrete that results in prepared holes which are deeper than the level of the adjacent prepared deck surface but not full- depth, require partial-depth patching. Depending on the depth of the partial-depth patch areas, the PEMS may direct that the prepared partial- depth holes be made full-depth.

On the other hand, if unsound concrete extends down to the top layer of the bottom reinforcement, all the concrete within the marked area is required to be removed. Such holes require full-depth patching before the overlay operation. The contract may require full-depth patching or the need for full depth patching may become apparent as removal of unsound concrete proceeds.

When the possibility of unplanned full-depth patching arises and the bridge has steel or precast concrete structural members, there should be no design or structural problems. However, bridges with poured-in-place structural members and slab-top type bridges may be a problem. While the areas for full-depth patching indicated on the plans should not be a problem, extensive unplanned full-depth removal require special measures. When the need for extensive full-depth patching arises, the removal in the affected areas is required to be stopped. The PEMS is required to be notified before proceeding with the removal. The design of the structure is considered before full-depth removal is attempted.

Following the removal operation, the Contractor is required to thoroughly clean the holes of all dirt, foreign materials, and loose concrete. The prepared surface is required to be firm, solid, and ready for the new concrete.

A minimum 1" vertical surface is required to remain or is cut 1" outside and around the entire periphery of each full-depth removal area unless the PEMS determines that cutting a vertical surface will damage the reinforcement. The vertical sides of the holes help assure that the patches stay in place.

RESOUNDING, RE-INSPECTING, AND ADDITIONAL REMOVAL

After the Contractor removes the concrete in the marked areas and cleans the deck, a request is made to INDOT to re-sound the deck. A quick response is needed so that the Contractor's overall operations are not delayed. The dates that the Contractor requested the resounding, when the sounding was done, and how long the sounding took are required to be recorded in the Technician's daily report.

The resounding requires that each hole and the perimeter be resounded to detect any bad concrete missed during the first sounding. The sounding is required to include between reinforcing bars, along the sides of holes, and around the perimeter of removal areas.

Cracking at the edges of holes, loose reinforcing bars, insufficient clearance around the reinforcing bars, and discoloration of the concrete due to scaly rust on the bars is required to be noted. All suspicious places are required to be resounded. Visual inspection continues to be important even at this stage of the operation.

When sounding around reinforcing bars, the reinforcing bars should not be hit as they sound the same as deteriorated concrete.

Holes that are determined to need additional concrete removal are required to be marked to unmistakably highlight the additional work required. Only this time the entire bad areas should be spray painted to ensure the area is noticeable to the work crew as to what should be removed. This should include painting any concrete that is required to be removed to obtain proper clearance for the reinforcing bars.

Any additional removal made necessary by the resounding is required to be done satisfactorily. Additional removal is accomplished by operating the hydrodemolition equipment or by hand-chipping using 15 lb. chipping hammers. Following the additional work, the entire deck is required to be inspected to ensure that all existing patches have been completely removed.

While most of the attention may be focused on the condition of the concrete, there is also concern with the condition of the reinforcing bars. Besides checking the bars for a minimum 1" clearance around exposed bars, the reinforcing bars are also checked for section loss from corrosion. If section loss is extensive, the bars are required to be replaced or another bar is spliced in.

CLEANING

Finally, the entire deck surface and especially the exposed reinforcing bars are required to be cleaned. Typically, the hydrodemolition process does a good job of cleaning the reinforcing bars. However, if some time has passed, there could be a light coating of rust that has formed on the cleaned reinforcing bars. After the concrete removal is completed, the entire surface is sandblasted, or water blasted to expose the sound concrete and to clean off the reinforcing bars. The Technician is required to ensure that the bars are cleaned on all sides, removing all loose, scaly rust. Also, the concrete under and around the exposed bars is required to be thoroughly cleaned by the blasting.

The Contractor is required to clean the deck of all dust, chips, and water and any substances such as grease and oil that may have spilled on the surface. The Specifications require that the air lines for sandblasting and the air cleaning be equipped with oil traps to avoid spillage of the oil on the surface.

Upon completion of the surface milling operation, the Contractor is required to keep all equipment that may leak off the deck. Substances such as grease, oil, and gasoline prevent the proper bonding of patching or overlay concrete.

MEASURING

Full depth areas to be patched are required to be measured and computed in square feet before they are poured. Bridge decks that have several patch areas close together may well need several Technicians to measure and document all the areas. To simplify the measuring and help ensure accuracy, the large, irregular areas may be divided into smaller, more regularly shaped areas.

The Contractor has the option of filling partial-depth patch areas with either bridge floor slab patching concrete (Section **722.07(b)**) or with the latex- modified concrete used for the overlay. Partial depth patch areas are not measured, because the hydrodemolition process should have done all of the removal work.

PATCHING PROCEDURE USING BRIDGE FLOOR SLAB PATCHING CONCRETE

An air compressor is required to be used to final-clean the holes. The compressor is required to be equipped with suitable separators, traps, or filters that remove water, oil, grease, or other substances from the air lines. Following this, all surfaces are required to be coated with epoxy resin adhesive (Section **702.20(a)**).

With the epoxy applied to all surfaces in the patch areas, the full depth patch areas are ready for the bridge floor slab patching concrete. The concrete mix is deposited in each hole to the level of the adjacent deck surface and thoroughly vibrated to consolidate the concrete and work the concrete around the reinforcing bars. The fresh mix is sampled, the required concrete tests are conducted, and test beams are made

The Contractor's finishing operation is inspected followed by the curing of the patches. The patches are required to be covered, kept moist, and cured in accordance with Sections **702.22** or **722.12**. Operation of equipment on the patched areas of deck not allowed until the test beams are broken and indicate a minimum modulus of rupture of 550 lb/in², after which construction traffic may be allowed on the deck.

EXPANSION JOINTS AND ROADWAY DRAINS

An important part of bridge deck repair is the replacement of expansion joints. Occasionally roadway drains will also need to be replaced. The work requires the replacement of the joints or drains as well as the removal of unsound concrete around the joints or drains. The unsound concrete is required to be replaced with new material. All this work is done according to the plans or as directed by the PEMS.

SS JOINTS (EXPANSION JOINT SS)

Type SS expansion joints consist of steel extrusions and anchors around which the structure concrete is poured. Spring-like neoprene strip seals are fitted between the extrusions to keep the joint opening sealed during expansion and contraction. Typical sections of SS joints are shown in Standard Drawings **724-BSSJ-01 to 09** along with details of the seals, steel extrusions, and anchors. The Contractor can pick from one of the four types of Standard SS joints.

To install an SS joint, the Contractor is required to remove the existing joint and portions of the deck concrete. The steel part of the joint is set in place and adjusted for temperature according to the setting noted on the plans. Then bridge deck concrete is poured on both sides of the joint. Once the concrete has cured, the strip seal is inserted between the steel extrusions. The strip seal flexes with the expansion and contraction of the bridge deck, from ½" to 4", to constantly maintain a watertight joint.

MODULAR JOINTS (EXPANSION JOINT M)

Figure 7-6 indicates a modular joint which is a steel expansion joint that allows for more expansion than the SS joints. Typical expansion of this joint is from 2 ¼" to 6" although more intermediate bars and seals can be added to increase the expansion range of this type of expansion joint.

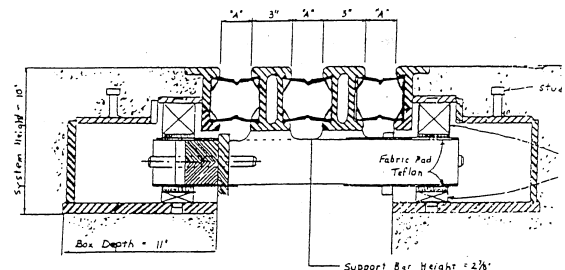

Figure 7-6 Modular Joint

MATERIALS

The materials that comprise latex-modified concrete are coarse and fine aggregate, portland cement, latex modifiers, fly ash, water, and admixtures.

AGGREGATES

The coarse and fine aggregates used in latex-modified concrete are required to conform to the gradation and other requirements indicated in Section **722.02** and **904**. Coarse aggregates are required to be crushed stone no. 11, class A or higher.

The sand (fine aggregate) and the crushed stone (coarse aggregate) are required to be stored and handled in ways that avoid contamination and maintain uniform moisture content. The following procedures are required to be followed:

1. Store fine and coarse aggregate in piles or bins entirely separate from each other
2. Ensure that the moisture content at the time of proportioning is such that the water does not drain or drip from the sample
3. Keep aggregates that are stockpiled on the job or at the final mobile mixer loading site covered with a moisture-proof material to prevent variations in moisture content
4. Ensure that moisture contents of successive batches vary no more than 0.6%
5. Verify that no foreign substances contaminate the aggregate either while in storage or during handling

PORTLAND CEMENT

Portland cement meeting the requirements of Section **901.01(b)** is used in latex-modified concrete. The mixing of different brands of cement is not permitted.

Cement that is stored prior to mixing is required to be kept in weatherproof enclosures that effectively protect the cement from dampness. No cement containing lumps may be used. Also, no cement should be lost during handling.

LATEX MODIFIERS

Section **912.04** gives the requirements for the latex modifiers. A type B certification is required for their acceptance.

Storage and handling of latex modifiers is required to be in accordance with the manufacturer's recommendations. The major concerns are:

1. Latex modifier to be stored is required to be kept in suitable enclosures that protect the modifier from freezing and from prolonged exposure to temperatures over 85° F
2. Drums of modifier are not to be stored in direct sunlight for more than 10 days
3. When stored in direct sunlight, drum tops and sides are required to be covered with suitable insulating blanket material
4. At the time the material is transferred from the drums to the mobile mixer tank, the modifier is required to be strained to remove solid particles
5. The latex-modified concrete to be used on the contract is proportioned according to Section **722.05**
6. The slump is measured 4 to 5 minutes after discharge from the mixer. During this waiting period, the mix may not be disturbed after being deposited from the mixer

FLY ASH

Class F or class C fly ash may be used in latex modified portland cement concrete. Section **722.05** provides additional information regarding the incorporation of fly ash into the concrete mix.

CALIBRATION

EQUIPMENT

Self-contained mobile continuous-mixing units, called "concrete mobiles", transport, proportion, and mix the components of latex-modified portland cement concrete and then discharge the mix on the bridge deck (Figure 7-7). Section **722.13** provides additional details on calibrating a continuous mixer.

PRE-CALIBRATION INSPECTION

The following procedures are intended to provide enough detail to establish that the concrete-mobile operator and the particular unit may produce the specified mix:

1. Check the truck manufacturer's inspection plate or mix setting chart for the serial number, proper operating revolutions per minute (rpm), and approximate number of counts on the cement meter to deliver 94 pounds of cement
2. Inspect the truck in general to ensure that the truck is clean and well maintained
3. Verify the aggregate bins are empty and clean and that the bin vibrators work
4. Verify that the cement aeration system functions, that the vent is open, and that the truck is equipped with a grounding strap. Check the cement meter feeder to ensure that all fins and pockets are clean and free of accumulated cement. If the operator cannot demonstrate that the cement meter feeder is clean without emptying the cement bin, all cement is required to be removed from the bin and the cement feeder inspected. The aeration system is required to be equipped with a gauge or indicator to verify that the system is operating. Observe that the main belts are clean and free of any accumulated material
5. Check the latex strainer screen to verify that the screen is clean

INITIAL CALIBRATION

A complete calibration is required for each concrete-mobile before each pour unless the initial calibration was made within the previous 10 calendar days. A mixer calibrated within the previous 10 days may be approved for use if the operator has the completed, signed, certified, and dated INDOT calibration form for that mixer. However, a complete calibration may be required at any time, as directed.

All mixers which were calibrated within the 10-day limit, but are changing aggregate sources, are required to have an aggregate blend test performed. All special equipment required for

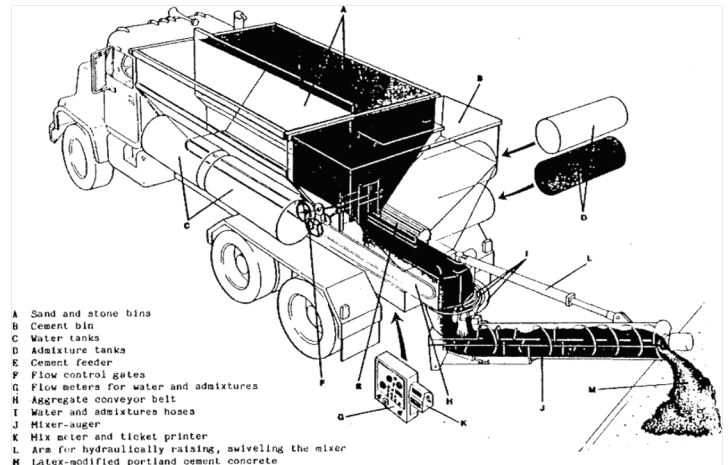

Figure 7-7 Self-Contained Mobile Continuous-Mixing Unit

calibration is required to be furnished by the Contractor. The equipment includes suitable material containers, buckets, stopwatches, and a set of balance beam platform scales graduated in at least ¼-pound intervals with a minimum capacity of 500 lb.

CEMENT METER

The truck manufacturer's mix setting chart determines the specified operating rpm and the approximate number of counts required on the cement meter to deliver 94 pounds of cement. At least 40 bags (3,760 pounds) of cement are required to be placed in the cement bin. The mixer is required to be on a level surface.

The engine throttle is adjusted to the required rpm. The unit discharges cement until the belt has made one complete revolution. The unit is stopped, and the cement meter is set to zero.

WATER FLOW METER

The accuracy of the water flow meter is required to be verified. First the flow is adjusted to two gallons per minute. Then, with the equipment operating at the required revolutions per minute, the water is discharged for one minute, collected, and weighed. The weight of the water is divided by 8.33 to compute the number of gallons discharged.

LATEX THROTTLING VALVE

This equipment includes a latex screening screen that is required to be unobstructed. The throttling valve is required to be adjusted to deliver 3.5 gallons of latex emulsion admixture for each bag of cement. That is: 3.5 gallons x 8.4 lb/gal = 29.4 lb of latex for each 94 lb of cement. With the unit operating at the required rpm for the time required to deliver 94 lb of cement, the latex emulsion is discharged into a container and weighed.

AGGREGATE BIN GATES

The aggregate bin gate openings are required to be adjusted by the operator to provide the required amount of aggregate to produce a cubic yard of concrete.

According to the mix composition referred to earlier, the ratio of fine aggregate to total aggregate is required to be $60 \pm 5\%$. This is verified by stopping the cement discharge and collecting the aggregate discharged into a container.

YIELD TESTS

After all adjustments have been made and normal operation has been established, the mixer is activated, and the concrete is discharged into a ¼ yd³ container. The typical size is 36" by 36" by 9". The unit is stopped at the predetermined number of counts needed to produce the ¼ yd³ of mix. The fullness of the container is checked. The aggregate gates are adjusted, if necessary. The counts accumulated on the cement meter are recorded while the concrete is being discharged. This procedure requires that the main clutch be engaged at precisely the same time the hydraulic mixing motor is started. Also, both controls are required to be disengaged at the same time. Yield tests using the ¼ yd³ box method are required to be conducted on the first load of each truck and on every third load per truck thereafter. Additional tests are required following any adjustments.

Slump and air content tests are to be conducted immediately after each acceptable yield test.

PREPARATIONS AND FINAL INSPECTIONS PRIOR TO PLACING OVERLAY

BLASTING AND CLEANING

The sand or water blasting and cleaning following the removal of the existing unsound concrete is required by the Specifications to be done just prior to placing the concrete. This means just ahead of the patching and overlay operations. If much time has passed between the patching work and placing the overlay, additional sand or water blasting and cleaning may be needed.

Sandblasting is required to cover the entire deck until sound concrete is exposed everywhere. The Technician is required to be sure that the sandblasting reaches all surfaces of the exposed reinforcing bars, as well as the concrete surfaces under and around the bars. However, the intent of the sandblasting is to clean the deck, not polish the concrete. Care should be taken to not over-blast the deck. Similarly, water blasting is required to clean the entire deck and exposed reinforcing bars.

The deck is required to be cleaned until the deck is free of all dust, chips, and water. The Contractor may use any equipment to do the clean-up, including power and manual brooms and air compressors; however, the equipment may not leave oil, grease, or other substances on the deck surface. The Specifications require that the air lines for the sandblasting and air cleaning equipment have oil traps.

FINISHING MACHINE SET-UP

An approved concrete finishing machine described in Section **722.10** is required to be used.

The screed rails for the finishing machine are required to be placed and fastened in position securely to ensure that the new surface is finished to the required profile. The anchorage for the supporting rails is required to provide horizontal and vertical stability. The rails may not be treated with a parting or bond-breaking compound to facilitate removal of the rails.

After the finishing machine is set up on the rails, dry runs like those conducted on bridge deck pours are required to be made to ensure that the overlay is placed to the proper depth and grade. The Contractor is required to measure down from the screed to the deck surface at frequent intervals. The grades at joints are required to be checked especially. During these dry runs, the proper operation of the finishing machine is required to be verified for the screeding action, vibration, forward and reverse movement, and other functions of the machine.

FINAL INSPECTIONS OF THE DECK

Existing expansion joints and dams are required to be maintained throughout the overlay placement. A bulkhead, equal in thickness to the width of the joint, is required to be installed to the required grade and profile before overlaying begins. All joints should be adequately protected.

The entire deck is checked for dirt, foreign substances, a clean condition of the reinforcing bars, and so on. Diligent protection of the deck following the sand or water blasting and cleaning cuts down on last-minute problems.

After the surface has been cleaned, and immediately before overlay placement begins, the Contractor is required to thoroughly soak the deck with water for one hour. The surface may not be allowed to dry before the overlay concrete is placed; however, there may be no puddles of standing water on the deck either. This is to provide enough moisture in the deck so that the deck concrete does not pull water from the overlay and prematurely dry it.

OVERLAY PLACEMENT

LIMITATIONS

Just as for the placement of all other types of concrete, there are limitations or restrictions for placing latex-modified portland cement concrete. These limitations concern the ambient temperature, precipitation, and time. Section **722.10** provides these limitations. Due to temperature restrictions and wind, it is common to place overlays overnight.

Overlays may not be placed unless the air temperature at the bridge location is 45° F and rising. Judgment should be exercised, and the weather forecast checked when the temperature is above 45° F but likely to fall. The air temperature at the bridge location is required to be 45° F or above and stay above 45° F during the placement of the overlay.

BOND COAT

With the concrete-mobile calibrated and otherwise ready to start, placement may begin. An application of a brush applied bond coat of latex-modified concrete on the wetted, prepared surface is first applied to all areas of deck surface that have been prepared by surface milling. This bond coat assures adherence of the overlay to the deck surface and fills irregularities. Portions of the deck surface that have been prepared using hydrodemolition do not get the brush applied bond coat.

When applicable, the Technician is required to ensure that all surfaces of the deck receive a thorough, even coating. Also, the speed of application is controlled so that the brushed material does not become dry before the surface is covered with additional concrete as required to reach the final grade.

Aggregate in the mix will become segregated during the brush application. If this occurs, it must be removed from the bridge deck before the rest of the overlay is placed.

As the bond coat is placed, surface irregularities are required to be filled to approximately $\frac{3}{4}$ of their depths. This procedure is required to be done sufficiently ahead of the placement of the rest of the overlay to allow the mix to stiffen and resist rolling back during the finishing.

FINISHING

Following the bond coat application and partial filling of any surface irregularities, the latex-modified concrete overlay is required to be placed to an elevation approximately $\frac{1}{2}$ " above final grade as described in Section **722.10**. The finishing machine then consolidates the concrete by vibration and finishes the concrete to the required grade. The machine finishing is required to be within 12" of the curb line or coping line unless otherwise directed. The Specifications require that supplemental hand finishing with wood floats be conducted as needed to produce the required tight, uniform surface.

Screed rails are required to be separated from the newly finished overlay by passing a pointing trowel along the interfaces between the rail and overlay. This is required to be done only after the concrete has set sufficiently so that the concrete does not flow back. The trowel cut is required to be made for the entire length and depth of the rail. The rails may be removed any time after the overlay has taken the initial set. The Contractor is required to take adequate precautions during and following rail removal to protect the edge of the new overlay from damage.

CURING

The overlay is required to be promptly covered with a single layer of clean, wet burlap. The Contractor is required to ensure that the burlap is well drained and is placed as soon as the surface supports the burlap without deformation. The entire surface shall then be covered with plastic sheeting and maintained in a saturated wet condition during the wet cure period. A network of soaker hoses shall be used under the plastic sheeting during the wet cure period for Latex Modified Concrete (LMC) and Silica Fume Modified Concrete (SFMC) overlays.

The minimum curing period for a LMC overlay shall be 48 hours of wet cure followed by 48 hours of dry cure. Traffic may be allowed on an LMC overlay during the dry cure period when compressive strength cylinders achieve a strength of 4,000 psi or greater.

The minimum curing period for a SFMC overlay is 120 hours of wet cure followed by 48 hours of dry cure. The SFMC overlaid bridge deck shall remain completely covered during the dry cure period. Traffic may be allowed on the deck after the dry cure period when the compressive strength of the cylinders reaches 4,500 psi or greater.

The minimum curing period for a Latex Modified Concrete, Very Early Strength (LMC-VE) overlay shall be 3 hours of wet cure. An LMC-VE overlaid bridge deck may be opened to traffic when the compressive strength of cylinders is 2,500 psi or greater.

The nature of the latex modifier in the concrete is to form a plastic film at the surface upon drying, usually within 25 minutes in hot, dry weather. The Contractor is required to ensure that this film is protected from dry cracking by covering the surface without delay.

If during the curing period the ambient temperature falls below 50° F, the number of hours that the temperature is below 50° F is not considered as part of the total curing period. Also, if during the dry curing period there is sufficient rainfall to wet the surface of the overlay for one hour or more, this number of hours is not considered in the dry curing period.

TEXTURING

Immediately after the overlay has been acceptably finished by the finishing machine and by minor hand finishing, and before a film forms on the concrete, the surface is required to be textured with a double thickness burlap drag or a minimum 4 ft wide turf drag – *grooving or tining plastic concrete shall not be allowed*. After curing requirements set forth in Standard Specification **722.12** are met, grooving may commence. The grooves provide skid resistance and help channel water off the bridge deck. The grooves shall be formed by a mechanical cutting device. Exact specifications for grooving are included in Standard Specification **722.11**. The grooving process shall be completed within 30 days of the last phase of construction.

Grooves are required to be terminated approximately 2 ft from the faces of curbs, concrete barrier walls, or other vertical walls. Grooving shall terminate approximately 6" from any expansion joint with steel nosing and 6" from the interface with adjacent roadway pavement.

No direct payment is made for texturing as this work is considered incidental to the overall work of placing the overlay and is therefore included in the contract unit price for the overlay.

POST-CURE INSPECTIONS, MEASUREMENT, AND PAYMENT

INSPECTING FOR CRACKS

Immediately at the start of the dry curing period, the surface is required to be checked for cracks. If there are any cracks, the Area Engineer is contacted. However, surface or crack sealing may not be done at this time. After a thorough investigation by the Area Engineer, cores may be required to determine the crack depths.

SOUNDING FOR BOND

Before the bridge deck is opened to traffic, the entire overlay surface is required to be sounded by the PEMS to verify that the overlay is securely bonded to the underlying bridge deck.

If sounding indicates that adequate bonding has not been attained, removal and replacement is required at the Contractor's expense.

METHOD OF MEASUREMENT

See Standard Specifications Section **722.15**.

BASIS OF PAYMENT

See Standard Specifications Section **722.16**.

PATCHING EXISTING OVERLAY

Existing bridge deck overlays may eventually require patching. The Specification requirements are contained in Section **722.14**.