

# Indiana Department of Transportation



CERTIFIED TECHNICIAN PROGRAM  
TRAINING MANUAL FOR

## Construction Earthworks







2024 Revision

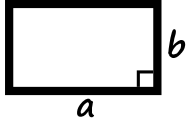
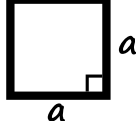

# MATH REFERENCES

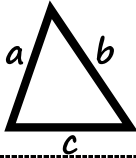
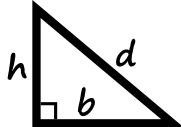
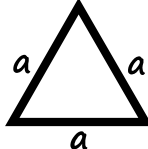
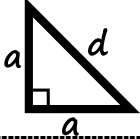
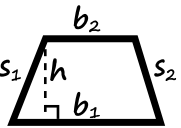
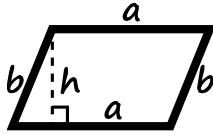
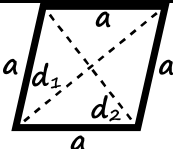
1 foot = 12 inches      1 square foot = 144 square inches      1 cubic foot = 1728 cubic inches  
 3 feet = 1 yard      9 square feet = 1 square yard      27 cubic feet = 1 cubic yard  
 5280 feet = Mile      1760 yards = 1 mile      1 acre = 4840 square yards

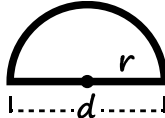
Rectangle		Square	
Perimeter	$2(a + b)$	Perimeter	$4a$
Area	$a \times b$	Area	$a^2$
Triangle		Triangle (any)	
Perimeter	$a + b + c$	Area by sides (no height)	$s = \frac{1}{2}(a + b + c)$
Area	$\frac{1}{2}(b \times h)$		$A = \sqrt{s(s - a)(s - b)(s - c)}$
Right Triangle		Equilateral Triangle	
Perimeter	$b + h + d$	Perimeter	$3a$
Area	$\frac{1}{2}(b \times h)$	Area	$\frac{\sqrt{3}}{4}a^2$
Isosceles Right Triangle		Trapezoid	
Perimeter	$2a + d$	Perimeter	$b_1 + b_2 + s_1 + s_2$
Area	$\frac{1}{2}a^2$	Area	$h \times \frac{b_1 + b_2}{2}$
Parallelogram		Rhombus	
Perimeter	$2(a + b)$	Perimeter	$4a$
Area	$a \times h$	Area	$\frac{d_1 \times d_2}{2}$
Circle		Semicircle	
Perimeter	$2\pi r$	Perimeter	$\pi r + 2r$
Area	$\pi r^2$	Area	$\frac{\pi r^2}{2}$

# AREA OF A CIRCULAR SEGMENT

$$\text{Area} = C \times b \times \text{coefficient}$$

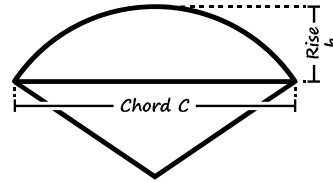

Coefficient	$\frac{b}{C}$
0.66667	0.00218
0.66668	0.00436
0.66669	0.00655
0.66671	0.00873
0.66673	0.01091
0.66676	0.01309
0.66679	0.01528
0.66683	0.01746
0.66687	0.01965
0.66692	0.02183
0.66697	0.02402
0.66703	0.02620
0.66710	0.02839
0.66717	0.03058
0.66724	0.03277
0.66732	0.03496
0.66740	0.03716
0.66749	0.03935
0.66759	0.04155
0.66769	0.04374
0.66779	0.04594
0.66790	0.04814
0.66802	0.05035
0.66814	0.05255
0.66826	0.05476
0.66839	0.05697
0.66853	0.05918
0.66867	0.06139
0.66882	0.06361
0.66897	0.06583
0.66913	0.06805
0.66929	0.07027
0.66946	0.07250
0.66964	0.07473
0.66981	0.07696
0.67000	0.07919
0.67019	0.08143
0.67039	0.08367
0.67059	0.08592
0.67079	0.08816
0.67101	0.09041
0.67122	0.09267
0.67145	0.09493
0.67168	0.09719
0.67191	0.09946

Coefficient	$\frac{b}{C}$
0.67215	0.10173
0.67240	0.10400
0.67265	0.10628
0.67291	0.10856
0.67317	0.11085
0.67344	0.11314
0.67372	0.11543
0.67400	0.11773
0.67429	0.12004
0.67458	0.12235
0.67488	0.12466
0.67519	0.12698
0.67550	0.12931
0.67582	0.13164
0.67614	0.13397
0.67647	0.13632
0.67681	0.13866
0.67715	0.14101
0.67750	0.14337
0.67786	0.14574
0.67822	0.14811
0.67859	0.15048
0.67897	0.15287
0.67935	0.15525
0.67974	0.15765
0.68014	0.16005
0.68054	0.16246
0.68095	0.16488
0.68136	0.16730
0.68179	0.16973
0.68222	0.17216
0.68265	0.17461
0.68310	0.17706
0.68355	0.17952
0.68401	0.18199
0.68448	0.18446
0.68495	0.18694
0.68543	0.18943
0.68592	0.19193
0.68642	0.19444
0.68692	0.19696
0.68743	0.19948
0.68795	0.20201
0.68848	0.20456
0.68901	0.20711

Coefficient	$\frac{b}{C}$
0.68956	0.20967
0.69011	0.21224
0.69067	0.21482
0.69123	0.21741
0.69181	0.22001
0.69239	0.22261
0.69299	0.22523
0.69359	0.22786
0.69420	0.23050
0.69482	0.23315
0.69545	0.23582
0.69608	0.23849
0.69673	0.24117
0.69738	0.24387
0.69805	0.24657
0.69872	0.24929
0.69941	0.25202
0.70010	0.25476
0.70080	0.25752
0.70151	0.26028
0.70223	0.26306
0.70297	0.26585
0.70371	0.26866
0.70446	0.27148
0.70522	0.27431
0.70600	0.27715
0.70678	0.28001
0.70758	0.28289
0.70838	0.28577
0.70920	0.28868
0.71003	0.29159
0.71087	0.29452
0.71172	0.29747
0.71258	0.30043
0.71345	0.30341
0.71434	0.30640
0.71524	0.30941
0.71615	0.31243
0.71707	0.31548
0.71800	0.31854
0.71895	0.32161
0.71991	0.32470
0.72088	0.32781
0.72187	0.33094
0.72287	0.33409

Coefficient	$\frac{b}{C}$
0.72388	0.33725
0.72491	0.34044
0.72595	0.34364
0.72701	0.34686
0.72808	0.35010
0.72916	0.35337
0.73026	0.35665
0.73137	0.35995
0.73250	0.36327
0.73364	0.36662
0.73480	0.36998
0.73598	0.37337
0.73717	0.37678
0.73838	0.38021
0.73960	0.38366
0.74084	0.38714
0.74210	0.39064
0.74337	0.39417
0.74466	0.39772
0.74597	0.40129
0.74730	0.40489
0.74865	0.40852
0.75001	0.41217
0.75140	0.41585
0.75280	0.41955
0.75422	0.42328
0.75566	0.42704
0.75713	0.43083
0.75861	0.43464
0.76011	0.43849
0.76164	0.44236
0.76318	0.44627
0.76475	0.45020
0.76634	0.45417
0.76795	0.45817
0.76959	0.46220
0.77125	0.46626
0.77293	0.47035
0.77463	0.47448
0.77636	0.47865
0.77812	0.48284
0.77990	0.48708
0.78171	0.49135
0.78354	0.49566
0.78540	0.50000

---

---

# MANUAL DISCLAIMER

---

---

The references in this manual are reflective of the 2024 INDOT Standard Specifications. The material covered herein is for training purposes only. The Standard Specifications, Contract Information Book, General Instruction to Field Employees, and Construction Memos should be consulted for determining the current inspection procedures for a given contract. On-site procedures, field tests, and other operating procedures may vary from those described within this manual.

---

---

## TABLE OF CONTENTS

---

---

<b>CHAPTER ONE: RIGHT-OF-WAY PREPARATION .....</b>	<b>1-1</b>
PRELIMINARY INVESTIGATION .....	1-1
STORM WATER MANAGEMENT .....	1-1
<i>Purpose</i> .....	1-2
<i>Storm Water Pollution Prevention Plan</i> .....	1-2
<i>Contractor’s Storm Water Quality Control Plan</i> .....	1-2
<i>Installation, Inspection, and Maintenance</i> .....	1-4
CLEARING AND GRUBBING.....	1-4
BORROW AND DISPOSAL SITES.....	1-5
REMOVAL OF STRUCTURES AND OBSTRUCTIONS .....	1-5
<i>Building and Foundation Removal</i> .....	1-5
<i>Inspection and Removal of Asbestos</i> .....	1-6
<i>Bridge Removal</i> .....	1-6
<i>Pipe and Sewer Removal</i> .....	1-6
<i>Pavement and Miscellaneous Removal</i> .....	1-6
<b>CHAPTER TWO: MATERIALS .....</b>	<b>2-1</b>
MATERIALS .....	2-1
<i>Soil Composition and Texture</i> .....	2-1
<i>Soil Classification</i> .....	2-2
<i>Field Identification and Classification of Soils</i> .....	2-2
ROCK AND SHALE EMBANKMENT .....	2-8
<i>Principle Rock Types</i> .....	2-8
<i>Rock</i> .....	2-8
<i>Shale, Shale and Soft Rock Mixtures, or Soft Rock</i> .....	2-8
<i>Shale and Thinly Layered Limestone</i> .....	2-9
OTHER EMBANKMENT AND FILL MATERIALS .....	2-9
SYNTHETIC MATERIALS .....	2-10
<i>Coal Combustion By-Products</i> .....	2-10
<b>CHAPTER THREE: EXCAVATION.....</b>	<b>3-1</b>
COMMON EXCAVATION .....	3-1

<i>Submitting Samples</i> .....	3-1
<i>Preparing the IT 530</i> .....	3-2
ROCK EXCAVATION.....	3-2
<i>Exploratory Drilling</i> .....	3-2
<i>Rock Pre-Splitting</i> .....	3-2
<i>Explosives</i> .....	3-3
<i>Primary Blasting</i> .....	3-3
<i>Restrictions</i> .....	3-3
<i>Finished Grade</i> .....	3-3
UNCLASSIFIED EXCAVATION .....	3-3
<i>Waterway Excavation</i> .....	3-3
<i>Class Y Excavation</i> .....	3-4
<i>Class X Excavation</i> .....	3-4
<i>Wet Excavation</i> .....	3-4
<i>Dry Excavation</i> .....	3-4
<i>Foundation Excavation, Unclassified</i> .....	3-4
DISPOSAL OF EXCAVATED MATERIALS .....	3-5
<i>Suitable Material</i> .....	3-5
<i>Unsuitable Material</i> .....	3-5
<i>Excess Material</i> .....	3-5
BORROW .....	3-5
<i>Contractor Responsibilities</i> .....	3-6
<i>Preparing a Borrow Pit</i> .....	3-6
PEAT EXCAVATION .....	3-6
<i>Treatment of Existing Fills</i> .....	3-7
<i>Treatment by Removal</i> .....	3-7
<i>Treatment by Displacement</i> .....	3-7
<i>Peat Disposal</i> .....	3-8

**CHAPTER FOUR: EXCAVATION CONSTRUCTION REQUIREMENTS .....4-1**

GENERAL PREPARATION.....	4-1
GENERAL REQUIREMENTS .....	4-2
TEMPORARY EROSION CONTROL .....	4-2
LIFTS .....	4-2
EQUIPMENT .....	4-3
<i>Hauling</i> .....	4-3
<i>Spreading</i> .....	4-3
<i>Compacting</i> .....	4-4

**CHAPTER FIVE: EMBANKMENT CONSTRUCTION .....5-1**

ROCK EMBANKMENT .....	5-1
<i>Lift Requirements</i> .....	5-1
<i>Compaction Methods</i> .....	5-2
SHALE AND SOFT ROCK EMBANKMENTS .....	5-2

<i>Lift and Compaction Requirements</i> .....	5-2
EMBANKMENT ON HILLSIDES AND SLOPES .....	5-2
EMBANKMENT OVER EXISTING ROADS.....	5-3
<i>Treatment of Existing RoadBeds</i> .....	5-3
COMPACTION CONTROL.....	5-3
SETTLEMENT CONTROL .....	5-4
<b>CHAPTER SIX: MEASUREMENT AND EARTHWORK CALCULATIONS .....</b>	<b>6-1</b>
CONTRACT QUANTITY PAYMENT .....	6-1
MEASURED QUANTITY PAYMENT .....	6-1
MEASUREMENT AND EARTHWORK CALCULATIONS .....	6-1
CROSS-SECTIONS .....	6-2
VOLUMES .....	6-2
PAYMENT .....	6-2
<b>CHAPTER SEVEN: SUBGRADE CONSTRUCTION .....</b>	<b>7-1</b>
CONSTRUCTION REQUIREMENTS .....	7-1
FINE GRADING.....	7-2
COMPACTION TESTING .....	7-2
<i>Proofrolling</i> .....	7-3
SUBGRADE TREATMENT .....	7-3
CHEMICAL MODIFICATION OF SOILS.....	7-3
MOISTURE CONTROL.....	7-4
UNDERCUTTING .....	7-5
MEASUREMENT AND PAYMENT .....	7-5
SUMMARY .....	7-5
<b>CHAPTER EIGHT: FINISHING.....</b>	<b>8-1</b>
SHOULDERS.....	8-1
DITCHES .....	8-1
SLOPES.....	8-1
EARTH GRADED ROADS .....	8-1
FINAL TRIMMING AND CLEANING .....	8-2
MEASUREMENT AND PAYMENT .....	8-2
<b>CHAPTER NINE: SPECIAL FILL AND BACKFILL.....</b>	<b>9-1</b>
B BORROW AND STRUCTURE BACKFILL.....	9-1
<i>Materials</i> .....	9-1
<i>Flowable Backfill Substitutions</i> .....	9-1
<i>Construction Requirements</i> .....	9-2
<i>Mechanical Compaction</i> .....	9-2
<i>Embankment for Bridges</i> .....	9-2
<i>B Borrow Around Bents</i> .....	9-3

<i>Compaction</i> .....	9-3
<i>Unbalanced Backfill</i> .....	9-3
<i>Spandrell Filling</i> .....	9-3
<i>Method of Acceptance</i> .....	9-3
<i>Basis of Payment</i> .....	9-4
FLOWABLE BACKFILL.....	9-4
<i>Proportioning</i> .....	9-4
<i>Flow</i> .....	9-4
<i>Average Penetration Resistance</i> .....	9-5
<i>Mixing Equipment</i> .....	9-5
<i>Placement</i> .....	9-5
<i>Limitation of Operations</i> .....	9-5
<i>Method of Measurement</i> .....	9-5
<i>Basis of Payment</i> .....	9-5
<b>CHAPTER TEN: MSE WALLS.....</b>	<b>10-1</b>
DESIGN.....	10-1
<i>MSE Wall Shop Drawings</i> .....	10-1
CONSTRUCTION .....	10-1
<i>Proofrolling</i> .....	10-1
<i>Preparation</i> .....	10-2
<i>Backfill</i> .....	10-3
<i>Reinforcement placement</i> .....	10-3
<i>Review</i> .....	10-4
<b>CHAPTER ELEVEN: AGGREGATE BASES .....</b>	<b>11-1</b>
AGGREGATE BASE .....	11-1
<i>Preparation of Subgrade</i> .....	11-1
<i>Temperature Limitations</i> .....	11-1
<i>Spreading</i> .....	11-1
<i>Compacting</i> .....	11-1
<i>Checking and Correcting Base</i> .....	11-2
<i>Method of Measurement</i> .....	11-2
<i>Basis of Payment</i> .....	11-2
SUBBASE.....	11-2
<i>Preparation of Subgrade</i> .....	11-2
<i>Temperature Limitations</i> .....	11-2
<i>Spreading</i> .....	11-2
<i>Compacting</i> .....	11-2
<i>Checking and Correcting Subbase</i> .....	11-3
<i>Method of Measurement</i> .....	11-3
<i>Basis of Payment</i> .....	11-3
AGGREGATE PAVEMENT OR SHOULDERS .....	11-3
<i>Preparation of Subgrade</i> .....	11-3
<i>Temperature Limitations</i> .....	11-3



<i>Spreading</i> .....	11-4
<i>Compacting</i> .....	11-4
<i>Checking and Correcting Base and Surface</i> .....	11-4
<i>Method of Measurement</i> .....	11-4
<i>Basis of Payment</i> .....	11-4
<b>CHAPTER TWELVE: LIGHT WEIGHT DEFLECTOMETER</b> .....	<b>12-1</b>
OVERVIEW .....	12-1
USING THE LIGHTWEIGHT DEFLECTOMETER .....	12-2
<b>CHAPTER THIRTEEN: DYNAMIC CONE PENETROMETER</b> .....	<b>13-1</b>
OVERVIEW .....	13-1
COMPONENTS & SETUP .....	13-1
USE OF THE DCP .....	13-2
<b>CHAPTER FOURTEEN: FAMILY OF CURVES AND ONE-POINT PROCTOR PROCEDURES</b> .....	<b>14-1</b>
MAXIMUM DRY DENSITY .....	14-1
FAMILY OF CURVES.....	14-1
ONE-POINT PROCTOR .....	14-2



---

---

# CHAPTER ONE: *RIGHT-OF-WAY PREPARATION*

---

---

Whether the work requires widening of an existing pavement section or the construction of a new roadway section through a new undisturbed right of way, certain preliminary investigations are required. The PEMS obtains right of way grants for all parcels of property purchased for the new work. These also include grants for temporary right-of-ways. From the construction plans, all right of way is staked so that the limits of ownership are clearly visible and areas of temporary ownership for construction are known. All INDOT employees and the Contractor are required to be aware of the limits so that no disputes arise over work activities outside our property or destroying or disturbing private property. Most work on the right of way has some involvement with public or private utilities.

---

## PRELIMINARY INVESTIGATION

During the completion of the plans, INDOT has already notified all public utilities and all pipeline owners or other parties affected so that they may plan to move and relocate their existing facilities. Delays caused to the Contractor by public utility companies can be a reason for time extension and possibly additional costs. Utility delays may cause contracts to be extended into another construction season.

Existing survey section corners and other survey-controlled points and benchmarks are required to be referenced for establishment when the contract is completed. The County Surveyor is contacted to obtain the proper location of all section survey references.

Another area of importance is the investigation of existing underground drainage. Farm field tiles placed by farmers are required to be outletted or continued across the project limits, so the drainage is uninterrupted. Legal county tiles and ditches are required to be maintained and preserved.

If the Contractor is required to assist in the investigation of underground drainage by excavation, this excavation is paid for as set out in Section **203**.

---

## STORM WATER MANAGEMENT

The Specifications require a Contractor to schedule and conduct its operations to minimize erosion of soils and to prevent sediment from reaching streams, irrigation systems, lakes, reservoirs, etc. Storm water management must be a topic of discussion in all pre-construction conferences. Requirements to schedule seeding and sodding operations as construction progresses, instead of waiting until the final stages of the project, should be stressed when discussing these operations with the Contractor. **The Construction Stormwater General Permit**, or *CSGP*, defines the State's regulations governing storm water management for land disturbing activities affecting one or more acres. These regulations are the responsibility of IDEM to enforce. Regulation compliance is the responsibility of the Contractor and INDOT.

The PEMS should have a thorough understanding of good storm water management, and the **Best Management Practices**, or *BMPs*, utilized by the Department. The PEMS should also understand the processes by which the Department obtains approval from IDEM to perform

construction projects under the CSGP and the requirements placed on the Contractor for storm water management by the contract documents. The Department's storm water BMPs are defined within the Standard Specifications, the Standard Drawings, the contract plans, and the Department's Storm Water Management Field Guide. The PEMS should review this information to understand the purpose and scope of erosion and sediment control established for the contract. Also, the IDEM Storm Water Quality Manual provides excellent reference information for review by the PEMS to ensure the project is compliant with the CSGP. It is strongly advised that the PEMS retain a copy of the CSGP for review and reference.

### ***PURPOSE***

The purpose of storm water management is to minimize or eliminate the potential for soil erosion and off-site sedimentation. At its core, storm water management has two basic processes. The first core process is erosion control. Erosion control measures are designed to maintain the soil on the ground, to keep the soil within the construction area, and to minimize its movement. Erosion control measures are more cost effective than trying to manage sediment after it has begun to move. Minimizing water or wind produced movement of soils from stockpiles, new embankments or ditch lines would fall within the erosion control category. The second core process is sediment control. Sediment control measures are designed to slow the movement of water to allow time for sediment particles carried by the water to settle and drop out of suspension. Sediment control measures are generally more expensive, require more maintenance, and are a less effective storm water management tool. The management of soil particles moving with storm water during a rain event would fall within the sediment control category.

### ***STORM WATER POLLUTION PREVENTION PLAN***

The Department's Environmental Services Section (ES) works with the designer and IDEM to obtain approval to publish the Notice of Intent (NOI) prior to letting a contract that will disturb one or more acres of land. INDOT's designer develops a preliminary Storm Water Pollution Prevention Plan (SWP3) to address anticipated land disturbing activities within the construction limits during the contract. Prior to contract letting, the plan is reviewed by ES, and occasionally by IDEM. Revisions are made as necessary to provide a workable plan that ultimately becomes part of the contract documents.

### ***CONTRACTOR'S STORM WATER QUALITY CONTROL PLAN***

Plans are incorporated into the contract to address the anticipated needs for storm water management during the different phases of the construction contract. However, since INDOT's designer, ES, and IDEM cannot foresee the exact methods and sequence of operations the Contractor may use on a given project, the Specifications require the Contractor to develop and submit for acceptance a Storm Water Quality Control Plan (SWQCP) to the PEMS describing the sequencing, prosecution, and phasing of the work for each stage of the construction contract. The SWQCP is required to be prepared and stamped by a licensed engineer who holds a current certification for a Certified Professional in Erosion and Sediment Control (CPESC), CPESC-In Training, or an approved equal. INDOT's design developed SWP3 and the Contractor's developed SWQCP work in coordination with each other to complete the requirements of the permit. The SWQCP, or any phase of the SWQCP, needs to be submitted

14 days prior to the start of any earth disturbing activities for that particular phase. The SWQCP must address:

1. Locations of all proposed soil stockpiles
2. Locations of all proposed equipment storage areas, fueling locations, construction trailers, batch plants, and designated concrete truck washouts
3. The SWQCP must also include a written plan for the collection, storage, and disposal of concrete washout wastewater. The capacity of the washout containers must be adequate to accommodate the size of the concrete pour. A secondary container also needs to be kept on site. The container must be leak free. Soils that are contaminated by spills must be disposed of in accordance with **202.08**
4. Proposed construction sequence and phasing of the erosion control measures
5. Locations of any entrances where vehicles or equipment will enter or exit the site
6. Material handling and spill prevention plan, which includes a listing of expected materials that may be present on the site during construction and the written plan of how those materials will be handled to minimize their potential for entering the storm water runoff from the site
7. Statements that the Storm Water Management features used shall, at a minimum, be inspected on a weekly basis and within 24 hours of every ½ inch rain event
8. Monitoring and maintenance plan for erosion and sediment control measures

Additional Contractor responsibilities within the SWQCP process include:

1. Designating a Storm Water Quality Manager (SWQM) to oversee and be in responsible charge of the Contractor's storm water management operations
2. Ensuring that the signed and dated SWQCP is submitted 14 days prior to any earth disturbing activities
3. Following their accepted SWQCP
4. Completing inspections of all installed BMPs at the correct frequency and documenting the inspections on the Storm Water, Erosion and Sediment Control Inspection Report
5. Amending and resubmitting their SWQCP as necessary to address changes during the construction of the project

The Storm Water Quality Control Plan is a "living" document and is required to be amended by the Contractor as new situations occur or as the plan of operation changes. Once the SWQCP is received from the Contractor, the PEMS will perform the following:

1. Review the SWQCP within 14 days of receipt utilizing the process outlined in **ITM 803**, Section 15 and the SWQCP checklist within Appendix I
2. Contact their Area Engineer for clarification and utilize the ES Permit Coordinator as an information reference for the SWQCP review
3. Sign and date the SWQCP to document the review of the methodology and approval of the content

In addition to the work covered by the contract documents and the SWQCP, the Contractor may also need to operate offsite borrow and disposal sites. Environmental permits for these sites are solely the responsibility of the Contractor and are not covered in any part by the Department's SWP3, the plans, or the contract permits. A copy of the Contractor's offsite operations NOI for items such as offsite stockpiles, borrow sites, waste sites, or storage areas shall be submitted to the PEMS prior to operations at those sites.

## ***INSTALLATION, INSPECTION, AND MAINTENANCE***

As defined within the Standard Specifications, the Contractor is responsible for the proper installation, inspection, and maintenance of all storm water management measures. In accordance with the permit, storm water management inspections are required to occur at a minimum frequency of once every 7 days, and either 1 day prior to or by the end of the next business day following each measurable storm event equal to or greater than ½ inch of rainfall. Inspection findings, both good and bad, shall be documented and recorded on the current Storm Water, Erosion and Sediment Control Inspection Report. The PEMS is responsible to ensure the Contractor's SWQM has submitted inspection reports correctly, in a timely manner, and in accordance with the permit requirements. Any additional storm water management features suggested by the Contractor's SWQM in the Storm Water, Erosion and Sediment Control Inspection Report should be evaluated and either accepted or denied by the PEMS on the inspection report. Evaluations of any proposed new storm water management features should include discussions with the AE, the district Erosion Control Specialist, and the ES Permit coordinator. They can help determine and ensure that the contract continues to meet the intent of the specifications, maintains economic value, and maintains compliance with all requirements of the permit. As with any plan, it is not uncommon for changes to be made in order for the plan to work properly. Similarly, the storm water management measures in the contract must be used to their best advantage to accomplish the job. The PEMS must use their best judgment and work with the Contractor, AE, district Erosion Control Specialist and the ES Permit Coordinator to adapt the best plan to fit the actual conditions of each project while still being as efficient as possible with the use of BMPs. All of the initiated changes should be documented as amendments to the SWQCP. The references and Department websites discussed within this section can be found in the Department's Storm Water Management Field Guide.

---

## **CLEARING AND GRUBBING**

When the Contractor arrives at the job-site, one of the first orders of business is to clear the right-of-way in preparation for construction. This work consists of the removal and disposal of all vegetation and debris within the limits of construction which are in the way of the construction work. Any items within the right-of-way that are designated to remain in place are not to be disturbed or damaged by the Contractor.

Trees that are encountered within the construction limits should only be removed when designated in the contract documents. If the tree stump is cut off level with the ground and is a minimum of 3 ft below the final subgrade, the stump may be left in place. If trees are completely removed, the roots from the stump are required to be grubbed from the ground around the old stump. Any holes created in the embankment area are required to be backfilled satisfactorily up to the level of the existing ground prior to starting the new embankment. Burning perishable items may only be done if local laws, ordinances, and the contract permit burning.

The measurement and payment of clearing of right of way is a somewhat complicated process. Payment may be by the acre, by a lump sum, by length, or by individual units. If tree removal is paid for by an individual unit, the tree is measured at a height of 24" above the ground. Any tree less than 4" in diameter is classified as brush and no payment is made.

---

## **BORROW AND DISPOSAL SITES**

The Contractor must submit proposed borrow and disposal site locations to the PEMS for approval. **Form IC 203, Request for Approval of Borrow or Disposal Site**, is available on the Department's website and must be completed by the Contractor for each proposed site and submitted to the PEMS for approval. The form requires the Contractor's signature certifying that they have complied with all environmental laws and regulations required to perform the planned operations at the site. The PEMS will review the form and sign it if properly completed. A site must be approved before the Contractor can begin operations at the site. Requirements for different types of sites can be found in **203.08**. The primary reason for the need to review and approve borrow and disposal sites is to help prevent Contractors from inadvertently dumping in a wetlands area or disturbing an archeologically sensitive site. A secondary use of the **IC-203** form is to document the disposal of materials generated on site that are taken to a Contractor's yard or other location. As the owner of the project, INDOT is responsible to take measures to prevent these occurrences. This form also serves to document the Contractor assuming ownership of salvaged materials. The specifications are intended to give the PEMS the tools necessary to reasonably ensure that the Contractor has taken appropriate measures to prevent borrow or disposal operations from becoming a violation of environmental laws. The PEMS must use their best judgment to reasonably determine when a given area may or may not require all environmental work to be done. By contract, the Department's approval of borrow or disposal sites does not relieve the Contractor of any obligations or penalties under the law. The Department will hold the Contractor responsible, not the PEMS, if an approved site turns out to be in non-compliance with any law or regulation. It is not the intent of the Department's procedures to place the PEMS in a position of responsibility for the Contractor's compliance with the laws, only to provide a means for the PEMS and the Department to be aware of the Contractor's planned sites and to obtain the Contractor's certification that they are compliant with the law. If the PEMS has questions about a given site, they should contact the AE for further guidance.

---

## **REMOVAL OF STRUCTURES AND OBSTRUCTIONS**

Most contracts require removal of structures and obstructions. This includes the removal and disposal of buildings, fences, structures, old pavement, abandoned pipelines, and any other obstructions that are not designated in the contract to remain in place.

### ***BUILDING AND FOUNDATION REMOVAL***

A Contractor is not allowed to begin removing a building without written authority from INDOT. For buildings or houses that are required to be removed, the Contractor removes the buildings and the foundations or basement walls to an elevation 1 ft below original ground. All debris and trash that is accumulated in a basement or foundation is removed. Any floor drains encountered are plugged, and any basement floors are broken. All public utilities to the building are to be shut off prior to beginning demolition. The Contractor is responsible for notifying the utility companies involved. Basements are backfilled with B Borrow in accordance with Section **203**.

Wells, cisterns, septic tanks, and other tanks are cleaned and backfilled in an approved manner. Cisterns, septic tanks, and other tanks that cannot be satisfactorily backfilled are removed. All abandoned wells are sealed and backfilled in accordance with Indiana code.

### ***INSPECTION AND REMOVAL OF ASBESTOS***

The contract documents will contain information on if the building contains asbestos. All State, Federal and Local regulations are required to be followed in cleaning up hazardous materials.

### ***BRIDGE REMOVAL***

Clearing of the right-of-way may include the removal of bridges, culverts, and other drainage structures. Bridge foundations are removed to the existing stream bed, and those portions outside the stream bed are removed 1 ft below the original ground. The removal of a reinforced concrete arch includes the removal of all associated pavement and backfill. Everyone one on the project is responsible to ensure all work in a stream is done according to the permits. Blasting should only be used in the demolition of bridges if allowed by Local ordinances. When a portion of a bridge structure is removed to widen an existing structure, care is taken not to damage the portion of the existing structure to remain in place.

### ***PIPE AND SEWER REMOVAL***

Materials not specified to be salvaged become the property of the Contractor. Sanitary and storm sewers no longer in use are removed from under the roadway and shoulders.

### ***PAVEMENT AND MISCELLANEOUS REMOVAL***

When the removal includes concrete pavement, sidewalks, curbs, and other miscellaneous concrete items, this concrete should be disposed of off the right-of-way. Payment for pavement removal includes the concrete pavement and all HMA overlay courses on existing public roads, streets, and alley pavements. Parking lots and driveways are not considered pavement removal. When a portion of pavement is removed, the limits of removal are marked and sawed along these limits to assure a smooth line of removal. Any portion that is damaged outside the removal lines is replaced at the Contractor's expense. Sawing of pavement to be removed is not paid for directly but is included in the cost of pavement removal.



---

---

# CHAPTER TWO: *MATERIALS*

---

---

## MATERIALS

All materials used in the construction of highway embankments, fills, subgrades, and subbases originate from the Earth. Most of these materials are natural in origin (the result of geologic processes that occur naturally) as opposed to synthetic materials (the result of industrial processes, such as slag or fly-ash). This chapter focuses on natural earth materials.

Earth materials consist of two types: soil and rock. **AASHTO M 146** defines soil as, “sediments or other unconsolidated accumulations of solid particles produced by the physical and chemical disintegration of rocks, and which may or may not contain organic matter.” Soil may also be defined as all unconsolidated materials overlying bedrock. The key word in these definitions is "unconsolidated". Soil is essentially natural material that is not indurated (hardened, cemented) into a cohesive mass. Soil exists in a loose, unbound condition and therefore may be easily excavated with construction equipment.

**AASHTO M 146** defines rock as, “natural solid mineral matter occurring in large masses or fragments.” Rock may be composed of hardened or cemented soil. The process of converting soil into rock is called lithification. Since lithification takes time and may be incomplete, the distinction between rock and soil may be unclear. For example, soil hardpans have been indurated by chemical action and may be quite hard but are not considered to be rock. Shale is another example: shale is considered rock by Geologists and soil by Engineers.

Soil and rock may be processed into aggregates by excavating, blasting, dredging, crushing, washing, and screening. These aggregates are considered natural aggregates since the chemical and mineralogical composition of the individual fragments or grains has not been altered. Natural aggregates are used extensively as materials for highway construction and are discussed in this chapter as well.

### **SOIL COMPOSITION AND TEXTURE**

Soil is made up of the following components:

1. Boulders
2. Cobbles
3. Gravel
4. Sand
5. Silt
6. Clay
7. Colloids
8. Organic material

Organic material aside, the components listed denote grain size and not origin or chemical/mineralogical composition. Organic materials are largely decayed plant matter and may be found in any state of decay.

Soil texture refers to the size and distribution of the components that comprise the soil. This is commonly referred to as the gradation of the soil.

## **SOIL CLASSIFICATION**

Section **903** and **AASHTO M 145** detail the classification system INDOT uses for all soils. Section **903** is strictly a textural classification system. **AASHTO M 145** has a textural component as well as an engineering property component. The liquid limit (**AASHTO T 89**) and plasticity index (**AASHTO T 90**) parameters are included in the classification system. When classification of a soil is required, a sample is submitted to the Office of Geotechnical Engineering. If the District is able to conduct all required tests, it may be submitted to your District Testing Laboratory.

### ***Organic and Marly Soils***

When discussing organic and marly soils, the terms *peat*, *marl*, and *muck* must be understood. The highly-organic *peat* is composed of decaying plant matter. *Marl* is calcareous clay (with calcium carbonate, calcium, or lime) often containing shell fragments. *Muck* is organic soil with a mix of dark, decomposed organic material and high silt content.

Organic soils are classified per **AASHTO T 267** and Section **903.05**. **AASHTO T 267** is used to determine the amount of organic matter in the soil and Section **903.05** classifies the soil based on the percentage of organic matter. Marly soils are classified per Section **903.06**.

## **FIELD IDENTIFICATION AND CLASSIFICATION OF SOILS**

Field classifications are generally conducted by the Office of Geotechnical Engineering or Consultant Geotechnical Companies. Though procedures for field classification are outlined herein, the Technician should interpret soil-boring descriptions more so than thoroughly classifying and describing soils. Soil boring logs from the geotechnical investigation accompany the contract proposal and plan sheets. These logs provide vital information concerning the soil types and potential material problems. Therefore, the Technician is required to read and interpret the soil descriptions, understand how the soil descriptions are written, and interpret what the terms mean.

Soil identification and classification in the field is based on visual inspection and simple field tests. The identification contains the following descriptions in this order:

1. Color
2. Moisture
3. Consistency or density
4. Textural classification
5. Modifying terms

### ***Class X Excavation***

The color of the soil is described in a wet condition.

### ***Moisture***

The soil moisture condition is described as:

1. Wet
2. Very moist
3. Moist
4. Slightly moist
5. Dry

### ***Consistency or Density***

The relative consistency of silt-clay material is described as:

1. Very soft – easily penetrated several inches by thumb. Exudes between thumb and fingers when squeezed in hand.
2. Soft – easily penetrated 1" by thumb. Molded by light finger pressure
3. Medium stiff – may be penetrated over ¼" by thumb with moderate effort. Molded by strong finger pressure
4. Stiff – indented about ¼" by thumb but penetrated only with great effort
5. Very stiff – readily indented by thumbnail
6. Hard – indented with difficulty by thumbnail

The relative density of granular material is described as:

1. Very loose – easily penetrated with ½" rebar pushed by hand
2. Loose – easily penetrated with ½" rebar pushed by hand
3. Medium dense – penetrated 1 ft with ½" rebar driven with 5 lb hammer
4. Dense – penetrated 1 ft with ½" rebar driven with 5 lb hammer
5. Very dense – penetrated only a few inches with ½" rebar driven with 5 lb hammer

### ***Textural Classification***

Textural classification is determined by estimating the amounts of gravel, sand, silt, and clay in the soil and then classifying the material in accordance with Section **903**. Since laboratory testing for particle size is not conducted, a few simple techniques for distinguishing fines are as follows:

1. Fine sand when rubbed between the fingers feels gritty and does not stain the fingers, whereas silt and clay materials feel smooth and leave a stain
2. Silt, when rinsed lightly with water, tends to wash off hands while clay sticks to hands

The following methods may be used in the field to estimate the soil texture, which is defined as the relative size and distribution of the individual soil particles or grains.

1. Visual Examination. By carefully looking at the soil, the material may be divided into at least the gravel, sand, and fines (silt and clay combined) components. Since the naked eye only distinguishes particle sizes down to about 0.05 millimeters, silt and clay sized particles cannot be separated without further magnification. The examination is done by drying a sample, spreading the material on a flat surface, segregating the material into various components, and estimating the relative percentage of each. The percentage refers to the dry weight of each soil fraction, as compared to the dry weight of the original sample. *Table 2-1* provides the defined particle sizes for each component and a common reference to aid in identifying the various particle sizes.
2. Sedimentation/Dispersion. This test is done by shaking a portion of the sample into a jar of water and allowing the material to settle. The material settles in layers. The gravel and coarse sand settle almost immediately, the fine sand within about a minute, the silt requiring as much as about an hour, and the clay remaining in suspension indefinitely. The percentage of each component is estimated by comparing the relative thickness of each of the layers in the bottom of the jar. The larger size particles typically settle into a denser mass than the fines.

Approximate Size Limits				
Classification		Measured	Sieve	Comparison Example
Boulders and Cobbles		Over 3"	> 3"	Grapefruit size
Gravel	Coarse	3" to 1"	3" to 1"	Lemon
	Medium	1" to 3/8"	1" to 3/8"	Diameter of penny
	Fine	3/8" to 2.0 mm	3/8" to 2.0 mm	Pencil diameter to pea or rock salt
Sand	Coarse	2.0 mm to 0.42 mm	No. 10 to No. 200	Broom straw diameter to sugar or table salt
	Fine	0.42 mm to 0.075 mm	No. 40 to No. 200	Human hair to powdered sugar
Silt		0.075 mm to 0.002 mm	< No. 200	Cannot be discerned with naked eye
Clay		< 0.002 mm	< No. 200	Cannot be discerned with naked eye

Table 2-1 Visual Grain Size Identification

### Granular Materials

Granular materials per **AASHTO M 145** have 35% or less passing the No. 200 sieve. These materials are sand and gravels with or without an appreciable amount of fines. These limits do not apply in field classification. Since texture is based on visually estimating percentages of the components, granular materials are more loosely defined in the field as materials that are composed predominantly ( $\geq 50\%$ ) of sand size or larger material. The general character of the soil is more granular than cohesive.

The following are guidelines for properly describing and classifying granular materials:

1. Estimate the largest particle in sample
2. Remove any gravel in the sample if present and estimate the amount.
3. Determine if the gravel or sand is clean or dirty
4. If the sample contains appreciable fines, determine if the fines are silty or clayey as outlined in Silt-Clay Material

Differentiation between clean and dirty may be made by two simple field tests as follows:

1. Settlement Rate Test – Place a small amount of the material in a container filled with water. The water clears in 30 seconds for clean sands and remains cloudy for dirty sands
2. Dust Formation Test – Dry out the granular material if moist. Sift the dry, granular material through your fingers and let the material fall on a hard, clean surface. If large amounts of silt and clay are present, the material that strikes the hard surface is dust

## Silt-Clay Materials

Silt-clay soils are composed predominantly of grains that visually cannot be distinguished in size. Besides the general techniques described earlier, several field tests may be used to distinguish silty from clayey soils as follows:

1. **Plasticity Test** – The ability to be molded within a certain range of moisture contents is termed plasticity. Plasticity is dependent upon the percentage and type of clay component, and therefore requires differentiation between silt (non-plastic fines) and clay (plastic fines)
  - For the ribbon/thread test (*Table 2-2*), a roll of soil moist enough to have workability, approximately  $\frac{1}{2}$ " to  $\frac{3}{4}$ " in diameter and about 3" to 5" in length, is pressed between the thumb and index finger into a ribbon of about  $\frac{1}{8}$ " thick. The longer the ribbon may be formed before the soil breaks under the soil's weight, the higher the plasticity of the soil. Highly plastic clays may be ribboned to 4" longer than the original material. Clay of low plasticity may be ribboned only with some difficulty into short lengths. Predominately silty soils do not ribbon or have ribbons that are delicate, softer, and easily crumbled. Non-plastic materials cannot be ribboned

Plasticity	Length of Ribbon, in inches
Non Plastic	0
Slightly Plastic to Plastic	0 - $\frac{1}{2}$
	$\frac{1}{2}$ - 1
	$\frac{1}{4}$ - 1
	0 - 1
Plastic to Highly Plastic	1 - 2
Highly Plastic	> 2

*Table 2-2 Ribbon/Thread Test*

2. **Dry Strength/Breaking Test** – The dry strength/breaking test is normally made on a dry pat of soil about  $\frac{1}{2}$ " thick and about  $1\frac{1}{4}$ " in diameter that has been allowed to air dry completely. Attempts are made to break the pat between the thumb and fingers. Very highly plastic clays are resistant to breakage and highly plastic clays are broken with great effort. Caution is exercised with highly plastic clays to distinguish between shrinkage cracks, which are common in such soils, and a fresh break. Clays of low plasticity may be broken with ease, therefore, clayey soils have medium to very high dry strength. Silty soils break readily and have no strength (non-plastic) to medium strength (slightly plastic). Non-plastic soils have very little dry strength, crumbling on being picked up by the hands
3. **Shaking/Dilatency Test** – In the shaking/dilatency test, a pat of soil about  $\frac{3}{4}$ " in diameter is moistened to a putty-like state and placed in the palm of the hand. The hand is then shaken vigorously or jarred on a table or other firm object. If the surface of the sample begins to glisten, this is an indication that moisture within the sample has

risen to the surface. When this does not occur, the soil is probably clayey. Where this occurs sluggishly or slowly, the soil is predominately silty, perhaps with a small amount of clay. For silts or very fine sands, the moisture rises to the surface rapidly, and the test may be repeated over and over by simply remolding and then reshaking the pat. This test is not generally done by INDOT

### **Marl, and Peat**

Marl and peat may be identified by visual inspection, color, smell, density, and compressibility. Peat is a highly organic soil characterized by undecayed to decaying plant matter, which gives the material a fibrous texture. Marl tends to have animal remains, predominantly shells. Organic soils are dull brown to black in color, spongy, and have a slight to strong odor of decay.

### **Modifying Terms**

When describing soils in the field, modifiers are used and included in the description, when appropriate. These modifiers are either textural or general.

Textural modifiers are used to indicate components that were not considered in the textural classification of the material. These include such materials as rock fragments, gravel particles, pieces of shale, etc. and are indicated as follows:

- Trace amounts – component comprises 0-10% of soil
- Little – component comprises 11-19% of soil
- Some – component comprises 20-35% of soil
- And – component comprises 36-50% of soil

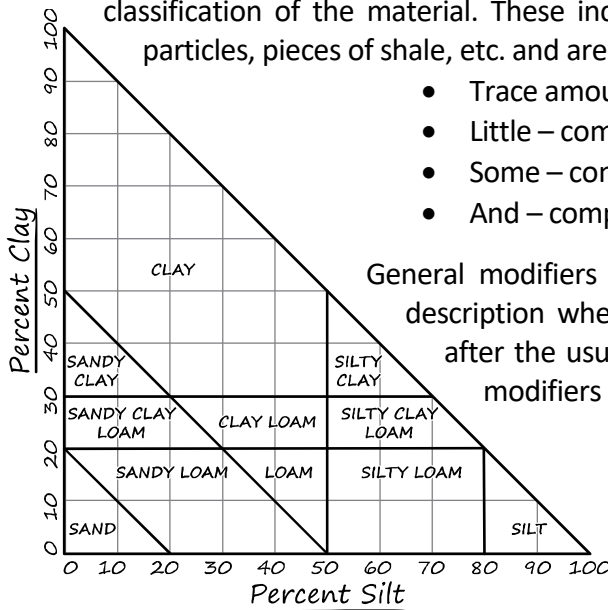

Figure 2-1 Soil Classifications

General modifiers may be very helpful and accompany the soil description whenever possible. They are noted in parenthesis after the usual soil classification. Some examples of general modifiers are:

- Fill material
- Apparently natural ground
- Peat
- Marl
- Till
- Old lake bed (lacustrine)

### **Examples and Interpretations of Field Descriptions**

All soil descriptions follow the same format. The color is described first, then the moisture, followed by consistency or density, and finally the textural classification, which is in all capital letters. The following is an example from an actual soil-boring log:

1. Topsoil (visual)
2. Brown, moist, very loose to medium dense, LOAM
3. Brown, moist, very loose, SANDY LOAM
4. Gray, moist, medium dense to loose, LOAM with little organic matter (LOI = 8.5%)
5. Gray, moist, very soft to medium stiff, SILTY CLAY LOAM
6. Brown and gray, weathered SHALE with interbedded layers of sandstone (visual), percent (%) recovery, and Rock Quality Description

Here is a quick explanation of the log entry:

1. The topsoil
2. A granular material. Granular soils have the density described, not the consistency. A range of densities may be used to describe the soil
  - Section **903.02** defines a loam as having as much as 50% sand and gravel. Therefore, since loam was considered granular, the sand-sized material probably was around 50%. Since the material obviously had large amounts of fines ( $\approx 50\%$ ), the material was classified as a loam as opposed to a sandy loam. Obviously, the sand was dirty
3. A granular material. Sandy loams have between 50-80% sand and gravel. This material was obviously granular to be classified as a sandy loam. Since the density was described as very loose, the material had considerably fewer fines than the sample above; however, there was enough to classify the sand as dirty and consequently the material is a sandy loam as opposed to sand
4. A granular material. Again, the material was composed predominantly of sand. The sample had a textural modifier, concerning the organic matter (LOI = 8.5%). The LOI is the "loss on ignition" of organic material (**AASHTO T 267**). The sample was tested in the laboratory for organic content and had obvious organic material in the material
5. A silt-clay material. The consistency of the material was described as opposed to the density. Again, a range of consistencies was given as opposed to a single consistency. The material obviously had considerably less sand than the previous samples and the fines were predominantly silt, not clay
6. The top of bedrock

The granular soils were apparently not gravelly. If they were gravelly ( $\geq 20\%$ ), the textural modifiers "*with some gravel*" or "*and gravel*" would have been used. No gravel was found in the soils at all since no textural modifiers were used.

Based on visual classifications and laboratory testing, Geotechnical Engineers refine the field boring logs.

Classification	% Sand & Gravel	% Silt	% Clay
Sand	80 - 100	0 - 20	0 - 20
Sandy Loam	50 - 80	0 - 50	0 - 20
Loam	30 - 50	30 - 50	0 - 20
Silty Loam	0 - 50	50 - 80	0 - 20
Silt	0 - 20	80 - 100	0 - 20
Sandy Clay Loam	50 - 80	0 - 30	20 - 30
Clay Loam	20 - 50	20 - 50	20 - 30
Silty Clay Loam	0 - 30	50 - 80	20 - 30
Sandy Clay	50 - 70	0 - 20	30 - 50
Silty Clay	0 - 20	50 - 70	30 - 50
Clay	0 - 50	0 - 50	30 - 100

Table 2-3 Soil Classification Chart

---

## ROCK AND SHALE EMBANKMENT

Rock and shale embankment is covered in Section **203.20**. INDOT considers three categories of rock and shale as follows:

1. Rock
2. Shale, Shale and Soft Rock Mixtures, or Soft Rock
3. Shale and Thinly Layered Limestone

To understand the differences in the materials, a greater understanding of rocks, Indiana geology, and the INDOT specifications is required.

### ***PRINCIPLE ROCK TYPES***

There are three general classes of rock: Igneous, Sedimentary, and Metamorphic. All of the rocks on earth fit into one of these classes.

Igneous rocks are rocks that were formed from cooled molten rock material called magma and are considered the original rock type. The rate of cooling and chemical composition of the magma determined the type of igneous rock, some examples being granite or basalt.

Sedimentary rocks are rocks that were formed from the accumulation, compaction, and cementation of fragmented earth materials, organic remains, and or chemical precipitates. These materials are collectively called sediments, hence the name. Sedimentary rocks are derived rock types that require the weathering and erosion of existing rocks for their formation. Examples of sedimentary rock are sandstone, limestone, and shale.

Metamorphic rocks are rocks that were formed from existing rocks that have been subjected to heat and/or pressure. This process metamorphoses or changes the rock mineralogically, texturally, and structurally. An existing metamorphic rock may be metamorphosed again by the geologic conditions. Examples of metamorphic rocks are marble (metamorphosed limestone), slate (metamorphosed shale), and gneiss (metamorphosed granite).

### ***ROCK***

Rock, as defined in **AASHTO M 146**, does not distinguish between soft rock and hard or durable rock. Section **203.03** defines what materials would classify as rock. Generally, materials meeting Section **203.03** are to be treated in accordance with Section **203.20(a)** rock embankment. This is not always the case, however, since some shale requires blasting as opposed to ripping with a bulldozer and all shale is covered under Section **203.20(b)** unless written permission is obtained to incorporate shale in accordance with Section **203.20(a)**. Therefore, careful consideration of the type of rock material in question is required before incorporating the material in embankments. When in doubt as to which section applies to the material, the Area Engineer, District Construction Director, District Testing Engineer, or the Office of Geotechnical Engineering is consulted.

### ***SHALE, SHALE AND SOFT ROCK MIXTURES, OR SOFT ROCK***

Shale is a sedimentary rock composed of clay, silt, or mud that is finely laminated. Shale appears in a variety of colors and may be highly variable in hardness. Shale belongs to a class of sedimentary rocks termed mudrocks.



The problem with mudrocks is that this material has an affinity for water. Because of the high clay content in mudrocks, they readily absorb water; however, these types of rocks are impermeable and do not allow the water to leave. This absorption of water results in a significant volume change in the material, causing the material to slake. Slaking is defined as the crumbling and disintegration of clay-rich materials when exposed to water. Clay-rich rocks, or argillaceous rocks, readily slake under alternate cycles of wetting and drying. Therefore, all mudrocks are properly treated in accordance with Section **203.20 (b)**.

Because of the propensity of shale or soft rock to slake, embankments constructed with these materials may experience problems as follows:

1. Settlement
2. Heaving, either from frost or alternating cycles of wetting and drying
3. Slope instability
4. Surface and subsurface erosion

Large pieces of unslaked material produce large voids when they eventually slake. The large voids cause settlement and possible eventual failure of the fill or embankment.

Heaving may also induce embankment failure. Shale and soft rock have a tendency to heave when an increase in moisture occurs or during freeze-thaw conditions. Heaving loosens the material, thereby decreasing the compaction of the lifts so the material no longer has the proper density. Again, settlement and failure of the fill may happen.

### ***SHALE AND THINLY LAYERED LIMESTONE***

Shale and thinly layered limestone may be common in some geographical areas in Indiana. When two rock types such as shale and limestone are found mixed together, they are termed interbedded.

Interbedded shale and limestone is essentially shale as defined in Section **203.20(b)** and rock as defined in Section **203.20(a)** intermixed. Therefore, the potential for slaking is present. Section **203.20 (c)** describes the construction requirements for these materials.

---

## **OTHER EMBANKMENT AND FILL MATERIALS**

Embankment and fill materials may or may not be aggregates and therefore are not required to originate from a Certified Aggregate Producer (CAP). In the case of borrow, there is no testing requirement for acceptance; however, the top 2 ft below the pavement is required to meet the requirements of the Section **207.03**.

1. Borrow - Borrow is defined in Section **203.08**
2. B Borrow – B borrow is defined in Section **211.02**
3. Structure Backfill - Structure backfill is defined in Section **904.05**
4. Aggregate Materials - Aggregate materials are required to originate from a Certified Aggregate Producer in accordance with Section **917**. Since these materials are certified, no testing for gradation by INDOT is required
5. Aggregate Base - The requirements for this material are listed in Section **301.02**
6. Subbase - The requirements for these materials are listed in Section **302.02**
7. Aggregate Pavements or Shoulders - The requirements for these materials are listed in Section **303.02**

---

## **SYNTHETIC MATERIALS**

Synthetic materials are by-products or waste materials that have been reclaimed and/or processed to be used in highway construction. Generally their usage is very limited and restricted.

### ***COAL COMBUSTION BY-PRODUCTS***

Coal combustion by-products are recovered from coal-fired power plants and include fly ash, bottom ash, and boiler slag. The requirements for these materials are included in Recurring Special Provision **203.23.1**.

---

---

## CHAPTER THREE: *EXCAVATION*

---

---

During the construction of a highway or bridge, existing materials may be required to be removed. These materials occupy the space in which a new highway or bridge is planned. Therefore, they are removed or "excavated." The types of excavation are:

1. Common
2. Rock
3. Unclassified

Some materials excavated may be suitable for use in construction of embankment. Some are not and are disposed of completely.

---

### COMMON EXCAVATION

Common excavation is the most frequently encountered type of excavation. The Specifications state that, "Common excavation shall consist of all excavation not included as rock excavation or excavation which is otherwise classified and paid for, including asphalt type pavement and all rippable materials".

Common excavation is the excavation of soil materials from within the contract limits; however, this excavation is not limited to soil materials and may include existing HMA pavement. If the material is indicated on the plans and is not a concrete pavement or another defined excavation, then the material is considered common excavation.

Section **203** further defines embankment construction as the excavation, hauling, and disposal or compaction of all material. Because compaction of the material is included in common excavation, soil samples are required to be obtained. These samples are submitted to the appropriate testing laboratory for determining compaction requirements and moistures.

#### ***SUBMITTING SAMPLES***

The manner of sampling and the number and the size of samples required depends upon two conditions:

1. The number of different soil types used on the contract. The submitter investigates each cut and borrow pit to determine the soil types. Only samples of the different types encountered are submitted
2. The method the Contractor expects to use in the removal and placing of the soil. If each type is worked separately, the soil is required to be sampled separately. However, if the Contractor expects to blend soil types, the soils are sampled accordingly. Blending may occur during excavating or placing. Therefore, communication with the Contractor is essential

If relatively few samples are to be secured, a 5" auger is a satisfactory tool for securing samples. Three foot extension sections of pipe may be required to reach the desired depth. The grading Contractor is required to supply a backhoe with an operator for securing a large number of samples or samples at depths greater than 5 ft.

The grade Technician may be required to determine where the samples are to be taken, obtain the samples, and submit the samples. Each soil sample is required to be a minimum of 25 lb and each granular material a minimum of 65 lb. A small portion of each sample is required to be retained for later reference.

### ***PREPARING THE IT 530***

When the samples are submitted to the District laboratory, they must be accompanied by an **IT 530** for each sample, with each sample including the following special information:

1. Centerline station and offset
2. Centerline station and offset for adjacent borrow pits
3. Elevation
4. Field office telephone number
5. Copies of applicable special provision sheets
6. Referenced specifications
7. Intended use
8. Description of soil as to texture, color, visual classification, moisture content, etc.

The laboratory will determine maximum density, optimum moisture content and sulfate content. These results are sent to the PEMS for use in determining in-place soil densities. The PEMS will need to use the portion of the submitted sample to compare to the in-place soil so the proper maximum density and moisture are used for acceptance of the placed fill.

---

## **ROCK EXCAVATION**

Rock excavation consists of the excavation of igneous, metamorphic, and sedimentary rock and boulders or detached stones having a volume of  $\frac{1}{2}$  yd<sup>3</sup> or greater. The material for this type of excavation is removed by blasting, by power shovel, or by other equivalent powered equipment. Unless otherwise specified or directed, the following criteria is used in excavating the material.

### ***EXPLORATORY DRILLING***

Exploratory drilling may be required to determine the existence of cavities and possible sink holes in cut sections. These holes are 1 ½" in diameter, and drilled on centerline at 100 ft intervals to a point which is 7 ft below the proposed grade. If a cavity or sink hole is found then additional holes are drilled along the edges of the pavement at 25 ft intervals. These holes are also drilled to 7 ft below the proposed grade. If the cavity has less than 5 ft of cover, then the cover is removed and the cavity treated as set out in the contract documents or as directed.

### ***ROCK PRE-SPLITTING***

The rock is pre-split by the use of drilling and explosives. The work is done in such a manner that minimum breakage occurs outside the neat lines of the typical cross section. The holes for this operation are from 2" - 4" in diameter, typically spaced 3 ft apart, and drilled 2 ft below the established grade of the cut or the predetermined bench elevation. The maximum depth of a pre-split lift is 30 ft. If a cut section requires more than one lift, the holes are drilled in such a manner that the specified offset for each succeeding lift is obtained. A horizontal distance of 2 ft off the back side of the paved side ditch line is required.

The pre-split face shall deviate no more than 6" from the front line and 1 ft from the back line of holes. The pre-splitting operation is kept well in advance of the regular blasting operations. The line holes are to be fired before the main excavation is blasted. There is no direct payment for pre-splitting because the cost is included in the cost of excavation.

### ***EXPLOSIVES***

The explosives to be used and the method of loading depends on the type of material to be blasted. A single strand of detonating chord or a solid column of dynamite may be used. The type used is required to be capable of pre-splitting the material with a minimum breakage outside the excavation area.

### ***PRIMARY BLASTING***

The holes for the primary blasting are drilled at least 6 ft away from the pre-split face. If additional charges are required, the holes are placed at half the distance of the full depth holes. These holes are drilled to a depth 2 ft above the pre-split face.

### ***RESTRICTIONS***

The Contractor is required to restrict the amount of explosives used near structures, rock formations, or other property that may be damaged. Adequate seismograph readings should be taken during blasting operations to document the impact on nearby buildings. It is in the Contractor's best interest to document the existing condition of nearby buildings prior to blasting operations.

### ***FINISHED GRADE***

The final breakage of rock is required to conform to or closely approximate the slope lines indicated on the plans. The final slopes are required to be left reasonably smooth and uniform with all loose and overhanging rock removed. Unless otherwise permitted, no rock is allowed to project more than 1 ft beyond the established slopes. If a natural seam intersects an established slope, permission may be granted to follow the seam face for an approved distance. If the Contractor provides a finished slope which is equal or superior to that which is obtained by pre-splitting, machine methods to establish final slopes may be used. The rock is excavated to the required elevation for the full width of the roadway as indicated on the plans or as directed. The final surface of the rock excavation is required to have proper drainage. If the rock is excavated below the required elevation, the rock excavation is backfilled to the subgrade elevation with crushed stone, spalls, subbase material, or other granular material.

---

## **UNCLASSIFIED EXCAVATION**

Unclassified excavation consists of the excavation of and proper disposal of any type of material that is encountered during the progress of the work.

### ***WATERWAY EXCAVATION***

Waterway excavation consists of excavation and the proper disposal of material encountered in the clearing of the waterways, making channel changes, or a combination of the two. The excavation does not include Class Y excavation or the excavation made for a structure as set

out in Section **206**. Waterways are excavated only according to the plans and the requirements of the 401/404 permit. No excavation should be allowed that is not shown on the 401/404 permits. Any discrepancies between the permit and plans should be discussed with the AE.

### **CLASS Y EXCAVATION**

While conducting normal waterway excavation, material may be encountered such as rock or material which consists of hard ledge rock, hard shale, conglomerate, concrete, masonry, or any similar material which is not part of the existing structure as indicated on the plans. If the material cannot be reasonably removed by any other method, the material is removed by blasting. This excavated material is defined as Class Y excavation. Section **203.07** defines material that may not be considered Class Y excavation.

### **CLASS X EXCAVATION**

One or more of the following materials encountered within the limits of foundation excavation are defined as Class X excavation:

1. Solid rock, hard ledge rock, slate, hard shale, or conglomerate. Because the material cannot be reasonably removed by any other method, blasting or pneumatic or equivalent tools are required for removal
2. Loose stones or boulders which are greater than  $\frac{1}{2}$  yd<sup>3</sup> in volume
3. Concrete, masonry, or similar materials which are parts of an old buried structure that was not shown on the plans
4. Timber grillages, old foundation piling, buried logs, stumps, or similar material that extend beyond the limits of excavation and are required to be cut off to be removed. These materials are removed back to the cofferdam limits and paid as Class X excavation

Hard pan is not considered as Class X excavation. The limits of Class X excavation are the neat lines of the footer unless the excavation lies above another type of excavation whose limits are different. In this case, Class X excavation is paid to the limits of the underlying material.

### **WET EXCAVATION**

Wet excavation is that portion of the foundation excavation, except Class X, which is below a horizontal plane designated on the plans as the upper limit of wet excavation and above the bottom of the footing. If the elevation of the upper limit of wet excavation is not indicated on the plans, an elevation of 1 ft above the elevation of low water level is used.

### **DRY EXCAVATION**

Dry excavation is that portion of foundation excavation, except Class X, which is above the upper limit of the wet excavation.

### **FOUNDATION EXCAVATION, UNCLASSIFIED**

Foundation excavation, unclassified includes all the work for wet excavation or dry excavation if no pay item is included for these items, regardless of whether or not water is encountered. Class X is not included in foundation excavation, unclassified.

If no upper limit of foundation excavation, unclassified is shown on the plans, the upper limit is the original ground, except where waterway excavation, common excavation, or other classified excavation overlaps the area of foundation excavation.

---

## **DISPOSAL OF EXCAVATED MATERIALS**

Excavated material may be classified as follows:

### ***SUITABLE MATERIAL***

If the material removed is suitable, then the material may be used for construction of embankments, shoulders, special fills, or other places as specified or directed depending on the nature of the fill.

### ***UNSUITABLE MATERIAL***

If the material is unsuitable for use in the embankment, the material is removed from the right-of-way. No unsuitable material can be disposed on private property without following the requirements of Section **203.08** and an approved Form IC 203.

### ***EXCESS MATERIAL***

Any excess excavated material that cannot be constructively used within the contract limits may be disposed of off the right-of-way, or used as directed to widen embankments or flatten fill slopes.

Excavation obtained from within the right-of-way and planned to be used in the embankment may be wasted and replaced with borrow if permission is obtained. However, the borrow is not paid for.

---

## **BORROW**

Borrow is a material obtained by the Contractor from locations outside of the right-of-way to complete the planned grading section. Frequently this material is obtained from properties adjacent to the right-of-way. Many of the areas that are "borrowed" from become ponds or small lakes. Hence the term "borrow pit".

Material such as river or lake deposit, cinders, or a soil mixture with a high organic content are not allowed. Borrow material is required to be free of substances that:

1. Form putrefying (rotting) deposits
2. Form deleterious (harmful) deposits
3. Produce toxic concentrations or combinations that may be harmful to human, animal, plant, or aquatic life

The following borrow materials that are not suitable for the growth of vegetation may be used:

1. Recycled materials such as coal combustion products, recycled foundry sand, granulated slag, etc.
2. Dune sand
3. B Borrow
4. Other granular material

When these materials are used they may not be placed within 1 ft of the required finished grade of the shoulders and slopes. The final 1 ft is required to be material suitable for the growth of vegetation. This material is required to be free from clods, debris, and stones.

### ***CONTRACTOR RESPONSIBILITIES***

When offsite borrow or the disposal of excavated material is necessary, the Contractor is required to comply with the requirements spelled out in Section **203.08**, Borrow or Disposal. These requirements are outlined on page 1-5. The Contractor will need to request approval of the borrow or disposal site on form IC-203 at least 14 days prior to when it will be used. The requirements for the Contractor request are in Section **203.08**.

### ***PREPARING A BORROW PIT***

Section **203.08** places limits on the location, planned excavation, and control of the drainage of the borrow pit. Upon approval of the site by all parties involved the Contractor may proceed with clearing the borrow pit site. Soil samples of the pit are taken and forwarded to the District Testing Department. Before any borrow material is removed from the pit, a base line is required to be established and the original cross-sections taken. The base line is established through or near the proposed borrow pit with the extremities of the line referenced outside of the excavated area. Sections should be taken well outside of the expected excavation area so the quantity can be determined if the amount of borrow is overrun. The reference line will need to be reproduced after the borrow material is removed. The quantity of borrow paid to the Contractor will be the difference from the original section and the final sections after the material is removed.

Precautions are to be taken to ensure that the references are not disturbed. In establishing a base line, consideration is given to the topography, the line of the cross sections, and the possibility of extending sections, if necessary. If the borrow pit includes a large area, an auxiliary line is run parallel to the base line to properly align the cross sections. Unless written permission is granted, there is no excavation below the elevation of the adjacent properties in a borrow pit within 150 ft of the nearest right-of-way line of an existing highway. A sketch is required to be made of the borrow pit layout in the permanent field notes. A description of the location of the borrow pit is placed on the sketch, such as, the number of feet right or left of a roadway station. The name of the property owner is also placed on the sketch.

---

## **PEAT EXCAVATION**

Peat is partly decayed plant matter that has collected in swamps and marshes over long periods of time and is generally the first stage in the formation of coal. Dried peat varies from a light yellow-brown substance to deeper layers of dark brown, compact material which looks like brown coal. Peat is not suitable for foundations of roadways because the material is unstable and subject to settlement when additional embankment is placed upon the deposit. Therefore, peat is required to be removed from under the roadway.

Peat excavation is the removal and satisfactory disposal of peat, marl, or any other unsuitable material and any overlying material. Extremely soft organic silt is found in lake bottoms and in static areas along river bottoms (flood plains). Marl is a water-deposited sand, silt, or clay containing calcium carbonate. Marl is sometimes found immediately below peat.



In rolling country where the ground rises sharply from the peat deposit, soils have often been washed over the edge of the original deposit. Some peat may be trapped under what appears to be the soil perimeter of the peat deposit. This also is considered to be peat excavation.

Removal of peat deposits may be done in several ways. Methods of treatment may be shown on the plans, as directed, or by other methods outlined in the Specifications. Because treatments detailed on the plans, or as directed, are not all uniform in application, only the methods outlined in the Specifications are discussed. The Specifications detail three methods for treatment:

1. Treatment of existing fills
2. Treatment by removal
3. Treatment by displacement

### ***TREATMENT OF EXISTING FILLS***

Treatment of existing fills is a method used to modify a fill over an existing peat deposit. The change may be in height and/or width. Treatment of existing fills may be done by several means as outlined in **203.16(a)** and is usually predetermined and outlined in the contract plans.

### ***TREATMENT BY REMOVAL***

The method of treatment by removal consists of completely removing the objectionable material by machine operations. This method is usually used when the following conditions exist:

1. The peat deposit is small in size
2. The peat deposit is shallow in depth
3. The peat deposit limits are completely within the construction limits or right-of-way

The following takes place during the method of treatment by removal:

1. New original cross-sections are taken. The entire area may have settled since the original survey
2. The width of excavation is to be the full toe of slope to toe of slope width of the proposed embankment
3. Final cross-sections are taken after the excavation is completed
4. Backfilling of the peat excavation follows as soon as possible to minimize the occurrence of slides
5. If water is not present, the excavation may be backfilled with borrow or common excavation
6. If water is present, the backfill is required to be B Borrow placed by end-dumping to an established grade of approximately 2 ft above free water level

### ***TREATMENT BY DISPLACEMENT***

Treatment by displacement is the most commonly used procedure for excavation of peat. This procedure is frequently used under the following conditions:

1. The peat deposit is large in size
2. The peat deposit is deeper than 10 ft
3. Water is present at all times
4. The free water level is high

The following steps are usually followed during this method of treatment, if conditions permit:

1. Each end of the deposit is removed until the depth of the peat excavation is greater than 10 ft. This may be subject to change as directed. If conditions permit, the upper portion of peat is excavated across the remainder of the deposit. Excavation of this upper level begins at one end and continues ahead of the displacement-backfill operation. The free water level usually controls the depth of this operation. Displacement-backfill operation is also known as "surcharge"
2. After the completion of the excavation, cased test holes are placed. These test holes determine the extent of peat displacement and are also used to determine final measurement of the excavation

The surcharge operation is the most difficult portion of the treatment to control. The weight of the surcharge literally pushes or squeezes the peat from the deposited area. A crane(s) with a drag line assists the surcharge procedure by removing the peat from in front of the surcharge. Since a properly constructed surcharge is very important, several guidelines are followed during the construction of the surcharge:

1. The surcharge is constructed of B Borrow
2. The top of the surcharge is constructed and maintained to a width equal to the full shoulder width of the embankment
3. The height of the surcharge is the same as the depth of peat being excavated. The original ground is the reference elevation for measuring the peat depths and the surcharge heights
4. The top of the surcharge is approximately level
5. The length on the top of the surcharge is at least 2 times the depth of the peat being treated
6. The surcharge is maintained and pushed forward as directed
7. The crane operation is coordinated with the rate of placing the surcharge

### ***PEAT DISPOSAL***

Once the peat deposit is excavated, by either removal or displacement, the excavated peat shall be disposed of in accordance with Section **203.08**.

---

---

# CHAPTER FOUR: *EXCAVATION CONSTRUCTION REQUIREMENTS*

---

---

## GENERAL PREPARATION

Prior to beginning excavation, grading, or embankment operations in any area, the following items are required to be completed:

1. Clearing and grubbing is conducted. This includes the removal of all perishable material such as tree roots, stumps, sod, weeds, agricultural debris, etc
2. Check sections are taken and checked satisfactorily with those on the plans. On contracts with construction engineering, the Contractor is responsible for securing check sections. The method of checking original cross sections is outlined in the *General Instructions to Field Employees*
3. After the previous items have been completed, the Contractor proceeds with scalping in areas where excavations are to be made, or embankments are to be placed. Another common term for scalping is stripping. Scalping is the removal of the upper 4" of the soils. Removal is necessary to ensure that decayable vegetation is not incorporated into an embankment. Although 4" is the minimum depth, topsoils containing large quantities of humus to a depth greater than 4" are removed until suitable materials are exposed. The removed topsoil should be stockpiled on site, this material will be spread as the upper layer on fill to get vegetation to grow. This is necessary to get the notice of termination, NOT, to close the permit. Scalping is completed to the limits the area where excavations are to be made or embankments are to be placed. The grading operations is inspected closely for unsuitable material. Roots and other large perishable objects are removed and stockpiled outside of the construction limits for later disposal
4. All pronounced depressions left in the original ground surface by removal of objectionable material from within embankment limits are filled with acceptable material and compacted to the density required for the embankment. The upper 6" of the original ground is compacted with a roller weighing no less than 10 tons, or with other approved compacting equipment
5. The final step before embankment placement is proofrolling. This work is done with an on-highway dump truck with a tire pressure of at least 90 psi. Proofrolling original ground uses a truck of at least 15 tons gross weight. All areas will need to have at least 1 pass with the proofrolling truck. This procedure also reveals all spongy and yielding materials which are not compacted. If soft areas are identified that will result in soft areas under the embankment they should be removed. The volume removed should be measured and paid in the common excavation item as undercutting. Judgment should be used in identifying these areas considering the height of embankment to be placed at that location. Identified areas within the proposed embankment are removed. The locations of spongy and yielding material may be detected visually

After proofrolling has been completed and all soft or unstable areas have been corrected, the area is ready for placement of the new embankment.

---

## GENERAL REQUIREMENTS

Excavated material that is suitable for embankment construction is placed in the embankment before placing any borrow material. This means that ditches are excavated first, since much of common excavation is derived from ditch cuts. The construction of ditches first also provides drainage for the embankment area. The roadway embankments are maintained higher at the center to promote drainage of the roadway.

---

## TEMPORARY EROSION CONTROL

Once the ditches have been completed, the Contractor begins placement of temporary erosion control devices as soon as possible. Failure to do so may cause pollution to drainage ditches, streams, and rivers adjacent to the project and is a violation of the CSGP. Some different types of temporary erosion and sediment control devices may include:

1. Perimeter protection
2. Drainage barrier at swale
3. Slope protection – interceptor ditches and slope drains
4. Sediment control in side ditches such as riprap ditch check, ditch sediment trap, or culvert pipe protection
5. Sediment basin
6. Inlet protection – curb inlet protection and drop inlet protection

These erosion control features are maintained until permanent erosion control features are in place. The need for erosion control devices is determined in the planning stages of the project, and erosion control devices are outlined and detailed in the construction plans. An SWQCP shall be submitted in accordance with Section 205. Items addressed in the plan include sequencing of operations; stockpile, equipment storage, and plant sites; borrow and disposal areas and haul roads, as well as any revision to the features shown in the plans. All appropriate erosion control items shall be in place prior to disturbing the project site. The Technician is responsible for ensuring that these devices are maintained. Inspection of control devices is required after rainfall exceeding ½" or at least once each week. Sediment basins must be cleaned and dikes or dams reconstructed if damage has reduced their effectiveness.

---

## LIFTS

The following factors must be considered as each lift of an embankment is constructed: Lifts are required to extend transversely over the entire embankment area. Doing this ensures that the outside slopes of the embankment are compacted as well as the middle of the embankment. The higher the fill, the more critical this becomes.

1. The fill width is required to be checked as the fill progresses. Failure to do so may cause fat or bellied slopes
  - a. Fat slopes are slopes which contain excess material or exceed the planned slope. Bellied slopes are slopes that do not contain enough material and these slopes are detected by viewing the slopes longitudinally
  - b. Bellied slopes are required to be corrected as the embankment is being built. Sidecasting is avoided as a solution since this usually develops a fill slough or slide at a future date

## EQUIPMENT

Equipment required for placing embankment consists of four categories;

1. Hauling equipment
2. Spreading equipment
3. Compacting equipment
4. Moisture control equipment

### HAULING

The method of hauling embankment material is determined by the Contractor and is based upon the following construction factors.

1. Type of material
2. Source of material
3. Conditions or obstacles between the source and area of placement
4. Availability of equipment

The equipment used for hauling includes:

1. Dump trucks
2. Earthmovers
3. Quarry trucks



Figure 4-1 Earthmover

Earthmovers (Figure 4-1) are frequently used for hauling embankment material. There are various sizes and models of earthmovers. Earthmovers are used in excavating, hauling, and placement of soil materials that are adjacent to or on the contract. When common excavation is required to be hauled across a bridge structure, when borrow material is obtained from a remote source, or hauling takes place over a road that is open to the public, dump trucks are used. Quarry trucks are used only in rock excavation.

### SPREADING

Because embankments are to be constructed in uniform layers, spreading equipment is necessary. Placing uniform layers may be done with several types of equipment or groups of equipment. The most common are the motor grader and the bulldozer. If soil conditions are suitable, earthmovers may also be considered as spreading equipment. This is done by the earthmover operator controlling the discharge of the materials in such a manner to create a uniform layer.

Because soil conditions may change dramatically, the earthmover is not the only spreading device necessary.

Another method of leveling layers uses a sheepfoot compactor with a blade (Figure 4-2). This equipment may be used instead of a motor grader. This is especially true on small grading projects.

A piece of equipment that may also be used during the spreading operation is the disc harrow (Figure 4-3). Although the disc does not level the soil, this equipment is helpful in creating a uniform layer.



Figure 4-2 Sheepfoot Compactor with Blade

The disc is used for:

1. Breaking up lumps, slabs, and clods
2. Aerating material to remove excess moisture
3. Incorporating water to increase moisture



Figure 4-3 Disc Harrow

## **COMPACTING**

Compacting equipment requirements vary from contract to contract. A list of the types of compactors which are most commonly used include:

1. Three wheel roller
2. Smooth drum vibrator roller
3. Vibratory tamping roller (Figure 4-4)
4. Static tamping roller or sheepsfoot
5. Crawler-tread equipment or bulldozer
6. Mechanical tamps or vibrators

The compactor to be used is determined by the Contractor and is dependent upon several factors:

1. Size of embankment
2. Type of materials being compacted
3. Conditions of materials being compacted
4. Availability of equipment
5. Contractor's preference

For placement of granular embankment material, three wheel and smooth drum vibrator rollers are preferred over tamping rollers. A dozer may be used in areas not accessible to conventional rollers, in building surcharges for peat excavation, or for rock embankments. Tamping vibratory rollers are preferable for shale embankment.



Figure 4-4 Single Drum Vibratory Roller

For placement of a clay soil embankment material, large slabs, lumps, or clods are required to be broken up before compacting. Breaking may be done by diking, but often a sheepsfoot roller is required to break up clods and low moisture lumps.

Table 4-1 is helpful in determining which compactors may be used for different materials. Whatever equipment is used for compacting, the goal is a uniform dense embankment.



Figure 4-5 Hand Vibratory Roller

<b>Compactor Type</b>	<b>Material</b>	<b>Lift Depth</b>
3 Wheel	all soils	8" maximum
Smooth Drum Vibratory	all soils	8" maximum
Tamping-Foot	soil or shale	Length of tamping foot
Crawler-Tread	Rock	see Specifications
Crawler-Tread	aggregates*	6" maximum
Smooth Drum Vibratory	aggregates*	6" maximum
Mechanical Tamp or Vibratory	Soils	6" maximum
Mechanical Tamp or Vibratory	Aggregates	4" maximum

*Table 4-1 Compactors to use by Material and Lift Depth*

\*Where impractical to conduct density tests.





---

---

# CHAPTER FIVE: *EMBANKMENT CONSTRUCTION*

---

---

The purpose of this chapter is to teach the Technician how to properly inspect embankment construction. The knowledge acquired will enable the Technician to implement the skills necessary to insure a good, solid, and lasting embankment which is absolutely necessary for a durable and safe highway. Different classifications of materials encountered, lift requirements, compaction methods, benching, density tests, moisture content, earthwork calculations, and Specifications relating to each particular area of embankment of construction will be discussed.

---

## **ROCK EMBANKMENT**

Rock excavation consists of removing rock which cannot be excavated without blasting. This material includes all boulders or other detached stones each having a volume of  $\frac{1}{2}$  yd<sup>3</sup> or more.

In a rock fill, the lifts are thick and the voids between the rock chunks are large. Although these voids are filled with fines at the top and sides of the embankment, inside the embankment many large voids remain. If these rock pieces remain intact, deformations are small within the embankment because of the friction and interlocking between pieces.

### ***LIFT REQUIREMENTS***

The requirements for a rock embankment are:

1. No large stones are allowed to nest and are distributed over the area to avoid pockets. Voids are filled with small stones
2. The final 2 ft of the embankment just below the subgrade elevation is required to be composed of suitable material placed in layers not exceeding 8" loose measurement and compacted to the required density
3. Shale or shale-like materials are not permitted in the upper 2 ft of embankment
4. Where the depth of an embankment is greater than 5 ft and consists entirely of rock, the rock is deposited in lifts not to exceed the top size of the material being placed, but in no case exceeding 4 ft
5. Where the depth of an embankment is 5 ft or less, or where the material being placed does not consist entirely of rock, the material is placed in lifts not to exceed the top size of the rock being placed, but in no case exceeding 2 ft
6. The rock for any particular lift is required to be deposited on and pushed over the end of the lift being constructed. If the voids of the last lift are not closed sufficiently, they are required to be choked with small broken stones or other suitable material and compacted as directed
7. Where a rock fill is to be placed over a structure, the structure is first covered with 2 to 4 ft of earth or other approved material, and properly compacted before the rock is placed
8. Shale is not incorporated as rock embankment unless written permission is obtained

## **COMPACTION METHODS**

When rock is used for embankment construction and has such a large top size as to make the material impractical to conduct density tests, such material may be compacted with crawler-tread equipment or with approved vibratory equipment, or both. Each lift is compacted thoroughly by successive passes back and forth with the tread areas overlapping enough on each trip so that all portions are compacted uniformly.

---

## **SHALE AND SOFT ROCK EMBANKMENTS**

If a rock fill were built of rocks which weathered rapidly in the fill, the rock pieces would become soil, which could in turn fall down into the rock voids. The cumulative result of this would be considerable settlement of the embankment and subsequent slope failure. Shales are a good example of this type of failure, since large pieces may degrade (slake) into soil which squeeze down into the large voids. The net result is that large settlements, and even slope instability, may occur.

### **LIFT AND COMPACTION REQUIREMENTS**

The requirements for lift placement and compaction include:

1. Shale, soft rock, and mixtures of these are placed in 8" maximum loose lifts
2. The compaction is required to be done with an approved vibratory tamping-foot roller in conjunction with a static tamping-foot roller. Each tamping foot on the static roller is required to project from the drum a minimum of 6". Each tamping foot on the vibratory roller is required to project from the drum a minimum of 4"
3. The moisture content is required to be controlled within -2 and +1 percentage points of optimum moisture content
4. The compaction is measured with a Light Weight Deflectometer. As an alternate to the LWD, Shale, shale and soft rock mixtures, or soft rock may be compacted to at least 95% of maximum dry density
5. Water is required to be applied to shale in the cut to accelerate the slaking action and again prior to disking and compaction. Water is paid for in accordance with **203.27(h)**
6. The water is required to be uniformly incorporated throughout the entire lift by a multiple gang disk with a minimum disk wheel diameter of 24"
7. Unless otherwise approved in writing, each embankment lift is required to receive a minimum of three passes with the vibratory roller. A roller pass is defined as being one complete coverage of a given area. The material is required to be bladed before using the vibratory roller

---

## **EMBANKMENT ON HILLSIDES AND SLOPES**

Before an embankment is placed on natural soil slopes or existing fill slopes steeper than 4:1, benches a minimum of 10 ft wide, unless otherwise specified, are cut into the slopes prior to the placement of embankment fill. Before placing embankment on natural soil slopes of 4:1 or flatter, the existing ground surfaces are plowed or deeply scarified.

If benches are cut, the excavation is paid for at the contract unit price per cubic yard for the class or classes of excavation encountered. No direct payment is made for plowing or scarifying.

---

## EMBANKMENT OVER EXISTING ROADS

Whenever constructing an embankment over an existing roadway, certain precautions are required to be taken.

### *TREATMENT OF EXISTING ROADBEDS*

1. If embankments for new pavement are to be placed over an area where a rigid pavement is in place and the upper surface of the existing pavement is 12" below the subgrade elevation of the proposed new pavement, the existing pavement is required to be removed
2. If embankment for new pavement is to be placed over an area where an existing rigid pavement is in place and the upper surface of the existing pavement is more than 12" but less than 3 ft below the subgrade elevation of the proposed new pavement, the existing pavement is required to be broken. The pavement is broken so that the area of any individual piece does not exceed 1 yd<sup>2</sup>
3. If embankment for new pavement is to be placed over an area where a hot mix asphalt surface on a concrete base is in place, and such existing surface is more than 12" but less than 3 ft below the subgrade elevation of the proposed new pavement, the hot mix asphalt is required to be removed and the concrete base is broken
4. If embankment for new pavement is to be placed over an area where HMA pavement is in place, the top of which is set at the approximate elevation of 12" or less above or below the required subgrade elevation of the proposed new pavement, the existing pavement is broken and removed to the depth directed, but no less than 12"
5. If embankment for new pavement is to be placed over any existing pavement, the top of which is greater than 3 ft below the required subgrade elevation, the existing pavement is left in place
6. If an embankment is to be widened, precautions are taken to ensure a firm foundation. After all perishable material has been removed, the existing shoulders are plowed down 2 ft out from the existing pavement. This material is used for widening. Benches, a minimum of 4 ft wide, are cut into slopes of the old embankment unless otherwise directed. No direct payment is made for plowing or benching, the cost thereof to be included in the various pay items of the contract

---

## COMPACTION CONTROL

The following compaction control requirements are included in the duties of the grade Technician:

1. Unless otherwise specified, all embankments are compacted to the target strength provided by the Geotech lab results or from a one-point proctor test
2. The moisture content needs to be kept within a specified range at the time of compaction. Section **203.23** provides the range of moisture contents for various types of soil
3. If the embankment material is too wet, the material is aerated to remove excess moisture
4. If the embankment material is too dry, the material is watered and disked to increase the moisture content

5. The embankment material is placed in uniform level layers and compacted with approved compacting equipment. Compacting equipment is required to include at least a three-wheel roller or other compacting equipment capable of providing a smooth and even surface
6. Each lift is disked or treated by some other mechanical means which ensure the breaking up of any existing lumps and clods
7. The loose depth of each lift is required to be such that the required compaction may be obtained, but in no case exceed 8"
8. Where a tamping roller is used, the loose depth of lift is required to not exceed the length of the tamper feet. The surface area of the end of each foot of the tamping roller is required to be no less than 5 in<sup>2</sup>
9. When silts, silty loams, or loessial type soils are encountered and used in embankment construction, the moisture content is controlled within -3 percent of optimum and the optimum moisture content
10. Field compaction tests are required to be conducted on each lift, and the required compaction obtained on each lift before the next lift is placed
11. The moisture content for sandy soil or a sand and gravel soil, having at least 80% sand and gravel size particles, is required to be such that the soils may be compacted to the specified density, which is normally several percentage points below optimum or as directed

---

## SETTLEMENT CONTROL

Preliminary investigation sometimes finds that the existing soil below the embankment settles over time when a heavy embankment is constructed. Therefore, settlement control is necessary to measure this settlement and to ensure that the settlement has slowed to an acceptable rate. The locations requiring settlement plates will be shown in the plans. This work consists of providing, installing, maintaining, and reading various types of geotechnical instrumentation at locations indicated on the plans or as directed as follows:

1. Prior to the beginning of embankment operations in any area, ½" by 3 ft by 3 ft settlement plates equipped with sections of ¾" and 2" galvanized threaded pipe and couplings for a cover are installed at locations as indicated in the plans
2. The ¾" pipe sections for the settlement plates are required to be 4 ft. Such pipe sections may be extended vertically from the center of the plates up through the new embankment as the embankment increases in height. The pipe sections are spot welded at the joints. A cover of pipe of 2" is slipped over the pipe and not welded to the plate. The ¾" steel pipe and 2" cover extend 2 ft or more above the grade of the new embankment at all times during grading operations and the settlement period
3. In addition to the settlement plates, lateral stakes are installed, if indicated on the plans. The stakes are required to be ¾" by 4 ft steel rods and are driven to at least 12" into the ground
4. B Borrow is used as embankment material around settlement plates and pipe to protect this equipment during construction
5. After the embankment has been constructed to subgrade elevation, settlement stakes are installed at the locations as set out in the plans. The stakes are required to be ¾" by 4 ft steel rods

6. During the construction of the embankment, elevation readings are taken on all settlement plate extension pipes and settlement stakes at the end of each 7-day period, or more frequently if the conditions warrant
7. After the embankment has been constructed to subgrade elevation, readings are taken on the settlement stakes, in addition to the settlement plate extension pipes. Lateral stakes are used to monitor horizontal movement of the ground or new fill. If lateral movement is observed during construction of the fill, the work is suspended and corrective measures are taken as directed
8. After the embankment is constructed to the subgrade elevation, a reading is taken every seven days until the settlement rate is  $\frac{1}{4}$ " or less for four consecutive weeks. The monitoring period may be reduced as directed by the Office of Geotechnical Engineering. If the results of any readings indicate that the new embankment has a settlement greater than  $\frac{1}{4}$ ", the monitoring period is extended until the settlement requirements are met
9. In the event that serious settlement develops during the construction of the embankment or within the required settlement period, the work is required to be suspended and corrective measures taken as directed



---

---

# **CHAPTER SIX: *MEASUREMENT AND EARTHWORK CALCULATIONS***

---

---

## **CONTRACT QUANTITY PAYMENT**

According to the Specifications, if the plan quantity of borrow, common and unclassified excavation is less than 15,000 CYD the plan quantity will be paid, unless either the Contractor or INDOT disagrees and can provide documentation showing another quantity was placed. When paying plan quantities for excavation, the following procedures are to be followed:

1. New original cross-sections are to be taken at 500 ft intervals and plotted to check the accuracy of the original sections
2. Final cross-sections are to be taken at 500 ft intervals. Cross-sections are required to be complete sections in cuts and from the shoulder break to the right-of-way in fills. These final sections indicate substantial conformance with the planned cut slopes and ditches and are used to determine if earthwork deductions are required
3. Spot checks are made of the cross-section areas indicated in the plans. The number of spot checks is required to average 1 per 2000 ft with the locations concentrated in areas of the major excavation. Additional area checks are made to determine whether the plan quantity needs to be adjusted for areas varying more than 10% from the area indicated on the plans. If the average deviation of all the areas checked varies from the planned areas at the corresponding locations by more than 2%, a more detailed check is required on the areas or balances showing the highest deviation
4. The computation of the volume from the planned areas of one balance is required to be checked. In general, this balance is the largest balance in the contract. Any other questionable balances are required to be checked for volume computations
5. Any other pertinent facts which would justify using plan quantity or indicating the need for adjustments is required to be considered

---

## **MEASURED QUANTITY PAYMENT**

Where measured quantities are specified or found necessary by the check of plan quantities, the excavated quantities will be computed by the average end area method. If "excess cut" or "waste" deductions, as described later, are applicable to the roadway excavation, they are deducted from the balance totals.

---

## **MEASUREMENT AND EARTHWORK CALCULATIONS**

Payment for grade construction is usually based on a bid price per cubic yard for excavation measured in-place as computed from survey notes. The unit price generally includes the following:

1. Hauling excavated material (cut) from within the limits of the roadway or bringing in other material from outside areas (borrow)
2. Building the embankments (fill) to specified form
3. Disposing of surplus material (waste)

4. Conducting such operations as forming earth shoulders, trimming slopes, and preparing the subgrade for pavement

---

## CROSS-SECTIONS

The determination of earthwork quantities is based upon field cross-sections taken in a specified manner before and after excavation. Cross-sections are vertical profiles taken at right angles to the survey centerline. Every section is an area formed by the road surface, the sideslopes, and the original ground surface.

---

## VOLUMES

Volumes are computed from cross-section measurements by the average end area method.

$$Volume \text{ (in } yd^3) = \frac{(A_1 + A_2)}{2} \times L \times \frac{1 yd^3}{27 ft^3}$$

$A_1$  and  $A_2$  are area measurements of a 2-dimensional cross-section, and  $L$  is the length between them, all measured in feet. When paying in  $yd^3$ , remember the conversion factor.

As all plan quantities are completed using this method, the Specifications require this formula to be used when documenting earthwork quantities for payment.

The formula for average end areas is most accurate when the area being calculated has generally straight lines connecting ends of similar shapes, like a trapezoid to a rectangle. In some cases, the formula may give volumes slightly larger than their true values. For example, when applied to a pyramid, for example, the error would be the maximum and would be equal to 50% of the correct volume. In practice, however, such an example wouldn't exist in the field, and for general field use, the total long-term error is seldom over 2%.

When impractical to measure material by the cross-section method due to erratic location of isolated deposits, acceptable methods involving three dimensional measurements may be used to measure material in the original position. Equations for these measurements are:

$$Volume \text{ (in } yd^3) = L \times W \times D \times \frac{1 yd^3}{27 ft^3}$$

Earthwork may also be measured on a linear basis. For linear grading items in a contract, the measurement for payment is based on the actual length of roadway mileage constructed. This includes all classes of excavation on both sides of the roadway. Small quantities of excavation may also be measured on a weight basis in accordance with Section **203.27**.

---

## PAYMENT

Generally speaking, payment for earth work is done either based on the measured volume of excavated material with the expectation that the material will be 'wasted' into the fill areas (additional fill material would be paid as borrow) or will be based on the measured volume of the fill areas, the embankment, with the Contractor using the material from the cuts as the source of material, any needed borrow would be included in the cost of embankment.



Borrow is measured and paid for by cubic yard. In most cases, borrow is cross-sectioned in the original position of the borrow before excavation begins and after excavation is completed. The volumes are computed by the average end area method.

Excavation may also be measured on a lump sum basis. When this occurs, no individual measurements are required.

There are many other special cases for different types of measurements and classes of excavation which may be encountered on a construction contract. For example when a suspended boulder with a volume exceeding  $\frac{1}{2}$  cubic yard is encountered during a common excavation activity the measured volume of the rock would be paid as rock excavation. The plans, Special Provisions, Specifications, General Instructions to Field Employees, and the PEMS are required to be consulted when starting an operation on a contract.



---

## CHAPTER SEVEN: *SUBGRADE CONSTRUCTION*

---

Subgrade is that portion of the earth roadbed which after having been constructed to reasonably close conformance with the lines, grades, and cross-sections indicated on the plans, receives the base or surface material. In a fill section, the subgrade is the top of the embankment or the fill. In a cut section the subgrade is the bottom of the cut (Figure 7-1). The subgrade supports the subbase and/or the pavement section. To ensure a stable, long-lasting, and maintenance free roadway, the subgrade is required to be constructed using certain proven procedures that provide satisfactory results.

After the rough grading is completed, the fine grade stakes are set and the final processing of the subgrade may begin. The rough grade is the top grade of the embankment as built using the information provided on the grade sheets. The grade is normally within 2" at this point. The finish grading operation consists of trimming the excess material down to the final grade. Filling any low spots with thin lifts of materials tends to slide these lifts around if not properly worked into the underlying materials.

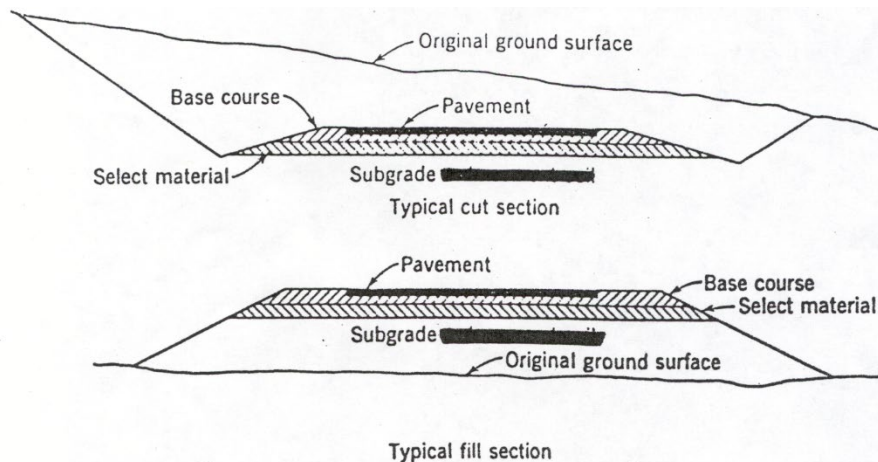

Figure 7-1 Typical Roadway Cross Sections

The subgrade is the base the pavement is built upon. As the upper surface, special consideration is given prior to the pavement construction. Subgrade treatment is constructed uniformly transversely across the width of the pavement including shoulders or curbs, unless indicated otherwise on the plans, by one of the following methods:

1. Chemical modification in accordance with Section **215**
2. Aggregate No. 53 or No. 43 in accordance with Section **301**
3. Geogrid in accordance with Section **214** placed under aggregate No. 53 in accordance with Section **301**
4. Soil compaction to 100% of maximum dry density

Longitudinally, the treatment may vary depending on the method of construction.

---

### CONSTRUCTION REQUIREMENTS

Soils containing greater than 3% by dry weight calcium, magnesium carbonate, or organic material, or with a maximum dry density of less than 100 lb/ft<sup>3</sup>, or with liquid limit of greater

than 50, or with a soluble sulfate content greater than 1,000 ppm are not allowed within the specified thickness of the subgrade. Area with planned chemical modification as subgrade treatment have additional requirements. Density is determined in accordance with **AASHTO T 99** and loss of ignition is determined in accordance with **AASHTO T 267**. Liquid limit is determined in accordance with **AASHTO T 89**.

Coal within the specified thickness of the subgrade is excavated, if directed, and disposed of in accordance with Section **202.05**. Coal or coal blossoms that are allowed to remain are mixed thoroughly with subgrade soils and compacted in accordance with Section **207.04**.

During subgrade preparation, adequate drainage is required to be provided at all times to prevent water from standing on the subgrade.

The final goal is to have a subgrade that meets the cross section and finish grade requirements as well as satisfying the density and proof rolling Specification prior to placing the initial subbase material. Even though the proof rolling is the last operation to be conducted, most of the potential soft spots are required to be detected and treated before the final grading is completed.

---

## FINE GRADING

Fine grade is required to be provided for the final trimming and checking of the cross section and grade. Most Contractors are now using GPS control on their grading equipment. This allows the grading to be accurately controlled. However the final grade still needs to be held to within ½ inch of the plan elevation. Adequate stakes are needed so the finish grade can be checked to assure that the grade is correct. The appropriate corrections for a crown in the typical cross section are used in calculating the correct offset distance. The tolerance for finishing the earth subgrade is ½" from the true grade. Any low areas in the grade requiring less than 3" additional fill material are scarified prior to placing the fill material so the thin layer of fill is tied into the previous layer when compacted.

Fine Grading (Figure 7-2) the subgrade for aggregate or asphalt base courses is usually conducted with a motorgrader with GPS control. The automatic grading machine is required to be used for preparing the subgrade for concrete base and pavement. When underdrains are specified, special care is required to be taken to ensure that there is no damage to the drains and that the aggregate backfill does not become contaminated with soil.



*Figure 7-2 Fine Grading*

---

## COMPACTION TESTING

Where the density and moisture control option is used, compaction of the embankment areas is required to be in accordance with Section **203.23**. The minimum number of tests required is outlined in the Frequency Manual. For mainline and shoulders, one test for each 1500 CYD for

each lift is required. For widening trenches  $\leq 5$  ft, one test each 1500 CYD is required. Any failing tests require additional work on the subgrade in that area to obtain the required density. Soil compaction at the optimum moisture content requires the least amount of compactive effort to obtain 100% maximum dry density. Therefore, drying excess moisture or adding water to a dry subgrade may be necessary to obtain this required density.

### **PROOFROLLING**

Even though the subgrade has been previously accepted, the condition of the subgrade at the time paving material is placed is required to be in accordance with Section **105.03** and Section **207.04**. Prior to placing the base course on the subgrade, proofrolling in accordance with Section **203.26** is completed. Undue distortion of the subgrade is avoided. If limits of the work make mechanical preparation of the subgrade impractical, appropriate hand methods may be used. Two complete coverages with the proofroller are required to verify the condition of the subgrade. All roller marks, irregularities, or failures are required to be corrected. Any depressions in the subgrade that hold water are required to be eliminated.

Preparing the subgrade well ahead of the paving operation helps insure a more uniform subgrade with fewer paving delays.

---

## **SUBGRADE TREATMENT**

The subgrade treatment type is required to be as specified on the contract plans.

Type I	24" of soil compacted in accordance with <b>203.23</b>
Type IA	Blank
Type IBC	14" chemical soil modification using cement
Type IBL	14" chemical soil modification using lime
Type IC	12" of coarse aggregate No. 53 aggregate in accordance with <b>301</b>
Type ID	12" coarse aggregate with Type 2B geotextile in accordance with <b>918.02(c)</b>
Type II	6" coarse aggregate No. 53 in accordance with <b>301</b>
Type III	In-place compaction in accordance with <b>203.23</b>
Type IV	12" Coarse Aggregate No. 53 with Type IB geogrid in accordance with <b>214</b>
Type IVA	12" coarse aggregate with geocell confinement system in accordance with <b>214</b>
Type V	3" of the subgrade excavated and replaced with 3" coarse aggregate No. 53

---

## **CHEMICAL MODIFICATION OF SOILS**

Chemical modification of soils consists of uniformly mixing dry Portland cement, fly ash, lime, or a combination of the materials with soil. This has the effect of raising the optimum moisture content allowing the compaction to take place when the soil is wetter. To aid in compaction, the lime or cement product is added at a rate of from 1% to 2%. When used for subgrade treatment, the lime or cement product is added at around 4.5%, depending on recommendations from the soil report.

The Contractor is responsible for all testing required to determine the optimum chemical modifier content for modification of the soils. The modifier selection, laboratory testing, and mix design are conducted by an approved geotechnical consultant in accordance with the Department's *Design Procedures for Soil Modification or Stabilization*. The test results,

recommendations, and type A certifications are submitted to the PEMS and Office of Geotechnical Engineering for approval at least 5 days prior to use. Based on the test results the quantity of chemical modifier may be adjusted from that shown in the specifications for different soil types. The source or type of chemical modifier may not be changed during the progress of the work without approval, and any change in source requires a new mix design.

Chemical soil modification is conducted when the soil has a minimum temperature of 45° F, 4" below the surface, and with the air temperature rising. The modifier is not allowed to be mixed with frozen soils.

The soil is scarified to a planned depth prior to placement of the chemical modifier when type A-6 or A-7 soils are used or encountered. The modifier is uniformly distributed by a cyclone, screw-type, or pressure manifold distributor. Spreading of the modifier is limited to an amount which may be placed into the soil within the same work day and during acceptable wind conditions.

The chemical modifier, soil, and possibly water are thoroughly mixed by rotary speed mixers until a homogenous layer of the required thickness has been obtained. Compaction of the mixture begins as soon as possible, but is required to be started within:

1. For cement modified soils, mixing is required to be completed within 1 h of cement placement, and compaction completed within 3 h after mixing.
2. Fly ash modified soils are required to be compacted within 4 h
3. Lime modified soils are required to be compacted within 24 h

The compaction effort is required to be in accordance with recommendations provided in the mix design. The moisture content of the mixture is required to be between optimum moisture and optimum plus 2%.

The compaction of the subgrade treatment is accepted based on the Dynamic Cone Penetrometer, DCP. For a Type I subgrade treatment the required DCP blow count is 17 for the top 6 inches and 16 for the bottom 8 inches of a 14-inch lift. For Type IIA subgrade treatment the required blow count is 20. DCP testing is done in accordance with 215.09. One passing DCP test is required every 1,500 feet for a 2-lane pavement. Testing may also be done with a LWD in accordance with 203.24(b), shown in Table 7-1.

Construction traffic is not allowed on the treated soils until the treated soils meet the DCP or LWD requirements.

When specified in the plans, subgrade construction may be constructed with geogrid and No. 53 aggregate in accordance with Sections **214** and **301**.

---

## **MOISTURE CONTROL**

The moisture content is required to be controlled during the subgrade treatment operations. The moisture requirement will be shown in the soil report. Careful monitoring and control of the moisture content of the soil during the special subgrade treatment process is essential for attaining a uniformly dense and stable subgrade.

Material Type	Allowable Average Deflection (mm)	Maximum Deflection at a Single Test Location (mm)
Lime Modified Soil	≤ 0.30	0.35
Cement Modified Soil	≤ 0.27	0.31
Aggregate over Lime Modified Soil	≤ 0.30	0.35
Aggregate over Cement Modified Soil	≤ 0.27	0.31

*Table 7-1 Allowable Average Deflection and Maximum Deflection for Chemically Modified Soils and Aggregate over Chemically Modified Soils*

---

## UNDERCUTTING

Providing surface drainage for the undercut areas is usually not possible. The size of the undercut areas is limited, and the undercutting should be scheduled so that an area is not left open when rain is likely. Water ponding in the undercut area would likely worsen the excess moisture problems that the undercut was designed to alleviate. The final moisture and density testing, and proofrolling are conducted on the top 8" of the completed subgrade near the beginning of the paving operation.

---

## MEASUREMENT AND PAYMENT

Subgrade treatment is measured in both cut and fill areas by the square yard. The cost of subgrade treatments including testing, sampling, aggregates, modifiers, geogrid materials, water, and any excavation required is included in the cost of the pay item for subgrade treatment. The under cutting of rock, where encountered, is measured in accordance with Section **203.27(b)**. Where conditions exist below the specified subgrade compaction depth that prevent achieving the specified compaction, payment for correcting such conditions is based on the directed method of treatment. The accepted quantity of chemically modified soils is paid for by the square yard, complete in place.

---

## SUMMARY

Proper subgrade construction and treatment is one more step toward the completion of a good roadway. The specified moisture and stability requirements are required when the subgrade is covered by any subsequent courses. Through careful schedule planning and construction, the Contractor may attain these results in the most economical way possible while providing a good, stable, subgrade.





---

---

## **CHAPTER EIGHT: *FINISHING***

---

---

Finishing consists of the final shaping and dressing of shoulders, ditches, and slopes by machine or by hand methods to the required smoothness, elevation, and cross section as indicated on the plans, or as directed. Finish work is usually undertaken after the paving has been completed. If the initial grading was not checked for reasonable conformance to the planned cross sections, the finishing operation may produce an excess or deficiency of material.

---

### **SHOULDERS**

The subgrade is constructed uniformly transversely across the width of the pavement including 2 ft outside the edge of shoulders or curbs. The shoulders are constructed with earth or other approved material which contains no sod, weeds, sticks, roots, or other perishable matter. The inside edges are built up above the surface of the adjoining pavement and compacted with a roller weighing no less than 5 tons. Rolling and shaping continues until the desired cross section and compaction is obtained. Shoulder areas that are not accessible to the roller are compacted with some other mechanical means that produce satisfactory results. Unless otherwise allowed, the outside edge of shoulder is required to be parallel to the pavement edges and be compacted the full width. The grade and slope of the shoulders may vary through super-elevated curves but in no case is water allowed to pond at the edge of the pavement or anywhere on the shoulder surface.

---

### **DITCHES**

Ditches are required to be constructed and finished to the grades and cross section as indicated on the plans, or as directed. All ditches are constructed so that they drain and are free from water pockets. Abrupt changes in grade and alignment of side ditches may cause erosion and are avoided.

---

### **SLOPES**

All cut and fill slopes are constructed to the cross sections as indicated on the plans, or as revised. Cut and fill slopes are finished to the degree ordinarily obtained by a grader blade. Slopes are required to be uniform without bulges and or dips. The length of transition for a slope change is required to be long enough to avoid the appearance of an abrupt change.

A slight roll back of the slope at the ends of a cut section is desirable for a more pleasing appearance. When finishing rock cuts, the rock face is carefully inspected for loose or overhanging rock that might fall on the roadway. All such material is required to be removed.

---

### **EARTH GRADED ROADS**

Earth graded roads are required to be finish graded to a reasonably smooth, uniform grade to at least within  $\pm 0.1$  ft of the required profile and cross section as indicated on the plans. Shaping and compacting is required to be conducted with approved equipment capable of providing a well-drained, finished roadway.

---

## **FINAL TRIMMING AND CLEANING**

Final trimming and cleaning consists of trimming and cleaning the otherwise completed highway between right-of-way lines for the entire contract length. At the time of acceptance of the contract, the following conditions are required for the entire length and right-of-way width of the contract.

1. All debris and rubbish removed and properly disposed of off of the right-of-way
2. All cut and fill slopes and any other areas that were disturbed left reasonably smooth and uniform
3. Any loose and overhanging rock removed
4. Weeds, brush, and stumps cut close to the ground and properly disposed of as directed
5. Waterways left unobstructed
6. Bridges cleaned of all rubbish, sand, stone, gravel, and dirt including the floors, roadways, railings, bottom chords, shoes, and seats
7. Culverts and other drainage structures left clean for their entire length

These provisions apply for all new construction contracts, including construction of pregrading contracts and paving contracts on pregraded contracts. For new construction of the second lane of a divided highway, the final trimming and cleaning requirement applies only to those areas of the right-of-way that were disturbed by the new construction. Unless otherwise specified for any contract built under traffic, the final trimming and cleaning provisions apply only to that portion of the right-of-way disturbed by the construction operations.

---

## **MEASUREMENT AND PAYMENT**

Finishing shoulders, ditches, slopes, earth graded roads, and final trimming and cleaning is not measured for payment unless otherwise provided. The cost of these items is included in the various pay items of the contract.

---

---

## **CHAPTER NINE: *SPECIAL FILL AND BACKFILL***

---

---

Special backfills play an important role in highway construction. Many times weak subgrades require special backfill to correct problems. Special backfill may also be necessary to facilitate good compaction around structures, such as catch basins, manholes, pipes, or bridge end bents.

The Technician is required to have a good knowledge of how special backfill is used for best highway performance. This chapter discusses materials, compaction, placement, and measurement of special fill and backfill.

---

### **B BORROW AND STRUCTURE BACKFILL**

Placing B Borrow and structure backfill consists of backfilling excavated or displaced peat deposits; filling up to designated elevations of spaces excavated for structures and not occupied by permanent work; constructing bridge approach embankment; and filling over structures and over arches between spandrel walls, all with special materials.

#### ***MATERIALS***

B Borrow used for special filling is required to be of acceptable quality, free from large or frozen lumps, wood, or other extraneous matter. Sand, gravel, crushed stone, air cooled blast furnace slag, granulated blast furnace slag, or other approved materials are used for B Borrow. The material is required to contain no more than 10% passing the No. 200 sieve and be otherwise suitably graded. The use of an essentially one-size material is not allowed, unless approved.

The Contractor has the option of either providing B borrow or structure backfill from a CAPP source or supplying the material from another source. The Contractor has the following options for supplying B borrow or structure backfill from a local site:

1. The establishment of a CAPP Producer Yard at the local site in accordance with 917; or
2. Use a CAPP Certified Aggregate Technician or a Consultant on the Department's list of approved Geotechnical Consultants for gradation control testing.

The frequency of gradation control testing is required to be one test per 2000 t based on production samples into a stockpile or by over the scales measurement, with a minimum of two tests per contract (one in the beginning and one near the mid-point). The sampling and testing of these materials is required to be in accordance with the applicable requirements of Section **904** for fine and coarse aggregates. The Contractor is required to indicate in writing the plan to measure the material to the PEMS and the District Testing Engineer.

#### ***FLOWABLE BACKFILL SUBSTITUTIONS***

When B borrow for structure backfill is specified, the Contractor may substitute flowable backfill in accordance with Section **213**. However, flowable backfill is not allowed to be placed into or through standing water, unless approved in writing.

## **CONSTRUCTION REQUIREMENTS**

If B borrow or structure backfill is obtained from borrow pits, the locations, depths, drainage, and final finish of the pits are required to comply with the provisions for these items in accordance with Section **203**.

If B Borrow or structure backfill is within embankment limits and if the entire fill or backfill is not required to be of B borrow and placed as such, then that portion above free-water level is required to be placed in accordance with applicable provisions of Section **203** and compacted to the required density.

If borrow is required outside the specified limits of B borrow, material in accordance with the Specifications for B borrow may be furnished at the contract unit price for borrow; however, the quantity of borrow measured for payment outside the limits of structure backfill may not exceed the theoretical quantity of B borrow furnished.

Unless otherwise specified, all spaces excavated for and not occupied by bridge abutments and piers, if within embankment limits, are required to be backfilled to the original ground line with B borrow and placed in accordance with Section **211.04**.

Where B borrow or structure backfill is required as backfill at culverts, retaining walls, sewers, manholes, catch basins, and other miscellaneous structures, the material is required to be compacted in accordance with Section **211.04**.

## **MECHANICAL COMPACTION**

Where B borrow or structure backfill is placed by mechanical compaction, the material, unless otherwise specified, is required to be placed in accordance with the applicable provisions of Section **203.23**. If mechanical tamps or vibrators are used, the material is required to be deposited in approximately 6" horizontal layers, loose measurement, and each layer compacted to density requirements.

## **EMBANKMENT FOR BRIDGES**

When special filling is required, the embankment for bridges are constructed using B borrow within the specified limits shown on the plans. All embankment construction details specifically set out in this Specification for embankment for bridges are required to be in accordance with the applicable requirements of Section **203**.

At the time B borrow is being placed for approach embankment, an earth, watertight, well-compacted dam is required to be constructed in level lifts, the details of which are shown on the plans. Except as hereinafter specified for material to be used in constructing the enclosing dam, and for growing vegetation, and unless otherwise provided, the material for constructing bridge approach embankment is required to be B borrow compacted by mechanical methods. If approach embankment or shoulders are constructed of material not suitable for growing seed or sod, then such areas are required, unless otherwise specified, to be covered with a layer of clay, loam, or other approved material which is suitable. This layer is required to be approximately 1 ft thick after being compacted into place.

## ***B BORROW AROUND BENTS***

When specified, B borrow is required to be placed around all bents falling within the limits of the approach grade as shown on the plans. Before placing, the surface of the ground on which the material is placed is scarified or plowed. The embankment slope is required to be 2:1 on the sides and beneath the structure, and 6: 1 from the end of the bridge down to the average ground line or may be required to complete the approaches back to the existing grade. The enclosing dam and provisions for growing vegetation are required to be in accordance with Section **211.05**.

## ***COMPACTION***

B Borrow and structure backfill placed behind the end bents needs to be properly compacted. The material is required to be deposited in lifts not to exceed 12" loose measurement. Each layer is mechanically compacted with two passes using a handheld vibratory plate compactor having a plate width of 17" or larger that delivers 3000 to 9000 lb per blow.

## ***UNBALANCED BACKFILL***

Unbalanced backfill is not allowed until the concrete required to resist the backfill has attained a flexural strength of 440 lb/in<sup>2</sup> for third point loading. The unbalanced height may not exceed 10 ft until the concrete has attained a flexural strength of 480 lb/in<sup>2</sup> for third point loading.

## ***SPANDRELL FILLING***

Unless otherwise specified, spandrel fills for arch structures are required to be composed of B borrow. The fill is carried up symmetrically in horizontal layers from haunch to crown and simultaneously over all piers, abutments, and arch rings. Compaction is required to be in accordance with Section **211.04**.

## ***METHOD OF ACCEPTANCE***

B borrow, structure backfill, and aggregate for end bent backfill is measured by the cubic yard as computed from the neat line limits indicated on the plans, or as adjusted. If cubic yards are set out as the pay unit for B borrow or structure backfill in the Schedule of Pay Items and if neat line limits are not specified for measurement of volume for the material, measurement is made by the cubic yard at the loading point in truck beds which have been measured, stenciled, and approved. The B borrow may be weighed and converted to cubic yards by assuming the weight per cubic foot to be 90% of the standard maximum wet density determined in accordance with **AASHTO T 99**. The material may be cross-sectioned in the original position and again after excavation is complete, and the volume computed by the average end area method. If B borrow is used for backfill in areas where unsuitable material is present or peat excavation has been conducted, the B borrow is cross-sectioned and the volume is computed by the average end area method.

If the material is to be paid for by the ton, the material is weighed in accordance with Section **109.01(b)**. If the material is obtained from a wet source such as below water or a washing plant and weighing is the method of measurement, there is required to be a 12 h drainage period prior to the weighing.

Geotextiles are required to be measured in accordance with Section **616.12**.

## ***BASIS OF PAYMENT***

The accepted quantities of B borrow are paid for at the contract unit price per cubic yard or per ton as specified, complete in place. If material which is in accordance with the requirements for B borrow is obtained within the excavation limits of the contract, the material is paid for at \$5.00/yd<sup>3</sup> as B borrow/structure backfill handling. No further payment is made.

Structure backfill is paid for at the contract unit price per cubic yard based on the neat line limits indicated on the plans or as adjusted for authorized changes, provided the material is obtained from outside the permanent right-of-way. If the schedule of pay items does not contain a pay item for structure backfill and this material is required to backfill pipes or culverts within the contract limits, a change order is needed to establish a unit price. Structure backfill placed outside the neat lines is paid for as B borrow if such backfill eliminates required B borrow material. Otherwise, no payment is made for backfill material placed outside the neat lines.

Aggregate for end bent backfill is paid for at the contract unit price per cubic yard based on the neat line limits indicated on the plans or as adjusted by authorized changes.

Geotextiles are paid for in accordance with Section **616.13**.

Flowable mortar, when substituted for B borrow or structure backfill, is paid as B borrow or structure backfill, respectively.

---

## **FLOWABLE BACKFILL**

Flowable backfill is used to fill trenches for pipe structures, culverts, utility cuts and other work extending under pavement locations and fill cavities beneath sloped wall and other locations in accordance with Section **105.03**.

### ***PROPORTIONING***

The Contractor must submit a mix design or use an established mix design from **213.03(a)**. If an established mix design is used, no trial batch is needed. If the Contractor chooses to provide a mix design, a trial batch is required. The mix design includes a list of all ingredients, the sources of each, the gradation of any aggregate, the names and dosage rates of all admixtures, and all batch weights. Except for adjustments to compensate for routine moisture fluctuations, mix design changes after the trial batch verification will require a new mix design approval.

Only the materials listed in Section **213.02** may be used in the flowable backfill mix designs. The proposed mix design materials and proportions are submitted to the District Testing Engineer. Final proportioning is determined based on the approved mix design.

### ***FLOW***

The test (**ASTM D 6103**) for flow consists of filling a 3" diameter by 6" high open-ended cylinder placed on a smooth level surface to the top with the flowable backfill. If necessary, the cylinder is struck off so that the mixture is level. The cylinder is pulled straight up within 5s. The spread of the material is then measured. The diameter of the spread is required to be at least 8". Flow adjustments may be made by making minor adjustments in the water or fly ash filler content in the mixture.

### ***AVERAGE PENETRATION RESISTANCE***

The Contractor will not be allowed to perform any construction activities with vibratory equipment until the penetration count with a DCP is at least 12. Activities without vibration will be allowed when the penetration count reaches 7.

### ***MIXING EQUIPMENT***

The mixing equipment is required to be in accordance with the applicable requirements of Section **702** or Section **722**. When using equipment in accordance with Section **722**, the yield will be demonstrated according to Section **213.07**.

### ***PLACEMENT***

The mixture is discharged from the mixing equipment by a reasonable means into the spaces to be filled. The flowable backfill is brought up uniformly to the fill line as indicated on the plans or as directed. Placing of material over the flowable backfill is not allowed until the DCP count has been reached.

Voids beneath a reinforced concrete bridge approach pavement are filled as directed. Holes are drilled at locations as directed and in accordance with Section **612.05**. The flowable backfill is placed until the bridge approach pavement has uniform support by means of completely filling all voids. During the filling operation, plugs may be required. Plugs are installed to confine the backfill as directed. The bridge approach pavement is required to not lift off the bridge seat.

### ***LIMITATION OF OPERATIONS***

Flowable backfill may not be placed on frozen ground and is required to be protected from freezing until the material has set.

The flowable backfill is not subject to any load nor disturbed by construction activities until the penetration resistance testing has been completed.

### ***METHOD OF MEASUREMENT***

Flowable backfill is measured by the cubic yard as computed from the neat line limits shown on the plans, or as adjusted. If neat line limits are not shown on the plans, the volume in cubic yards of flowable backfill furnished and placed is computed from the nominal volume of each batch and a count of the batches. Unused and wasted flowable backfill is estimated and deducted. Drilled holes are measured by the number of holes drilled.

### ***BASIS OF PAYMENT***

The accepted quantities of flowable backfill are paid for at the contract unit price per cubic yard furnished and placed.

Filling voids beneath a concrete bridge approach pavement is paid for at the contract unit price per cubic yard for flowable backfill. Holes drilled in the pavement are paid for at the contract unit price per each.





---

---

# CHAPTER TEN: MSE WALLS

---

---

## DESIGN

MSE walls are constructed in accordance with Section 731. The wall system is chosen by the Contractor from the department's list of approved systems. The Contractor will require the services of a PE to provide the final design for the wall. The structural integrity of the wall depends on the designer accounting for many factors in his design including the height, limits, weight of the backfill material and internal friction angle of the fill material. The final design along with shop drawings for the fabrication of the wall panels will need to be submitted according to the procedure below. The shop drawings will need to include information on the back fill material.

### MSE WALL SHOP DRAWINGS

Shop Drawings are submitted by the fabricator in order to provide more specific details on how the wall is to be constructed. The plans and design calculations for MSE retaining walls are to be submitted by the Contractor or fabricator directly to the Engineer of record (EOR) for review and approval. MSE shop plans and design calculations must be stamped by a P.E. Upon receipt, the EOR should forward an electronic copy of the shop drawings and design calculations to the INDOT Office of Geotechnical Services.

The INDOT Office of Geotechnical Services will review the design calculations and will provide any necessary comments back to the EOR for inclusion in the response back to the Contractor or fabricator. The EOR will provide the final approval of the MSE shop drawings and design

calculations. The EOR will send a copy of approved shop plans to the submitter and to the District Construction office for further distribution. Construction will not be allowed to begin until these drawings have been approved. Below are 2 items that are included in a typical set of Shop Drawings that should be reviewed and followed as closely as possible. A *General Note* page is part of the shop drawings and contains important information regarding wall design and construction. This page should be reviewed by the inspection team prior to the start of construction.

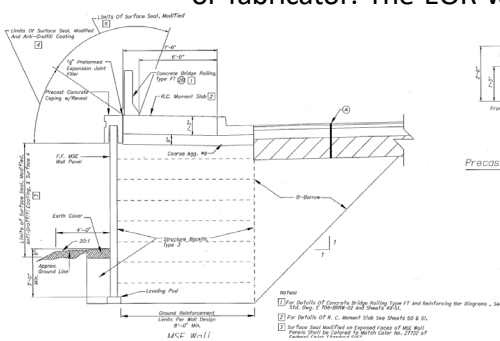

Figure 10-1 Example MSE Wall Plans

Orientation of straps including orientation when obstructions such as piling or drainage structures are encountered. See Section 731.04 for other items included in Shop Drawings.

---

## CONSTRUCTION

### PROOFROLLING

The MSE wall and the associated backfill material and the roadway have a significant total weight and as such there will need to be a well-constructed foundation. The wall panels are constructed on the leveling pad. This will be shown on the plans with the location and elevation. The area of ground reinforcement will need to be proof roller to assure a firm

foundation base for the wall. Figure 10-2 shows an area of proofrolling that does not pass for an acceptable base for MSE wall.

Any locations that are unable to be compacted to pass proofrolling will need to be undercut and the proper material placed and compacted.

Figure 10-3 shows an adequately compacted area as demonstrated by proofrolling.

When the panels and other material are delivered to the jobsite they will need to be inspected for compliance with the approved drawings. Some areas to note are that the correct panels (size, shape, soil reinforcement connections and layout) are delivered. The panels will need to be stored to prevent damage. You will need to assure that the correct straps, size and length and type are delivered. If any panels are damaged they will need to be rejected or repaired according to the manufacture's recommendations.



*Figure 10-2 Unacceptable Compaction*



*Figure 10-3 Acceptable Compaction*

## **PREPARATION**

Once the foundation has been excavated to the correct elevation and compacted and passes proofrolling the construction of the wall system can begin. The leveling pad will be built according to plans and any modifications specific to the chosen wall system. Per Section **731.07** the leveling pad will need to cure for a minimum of 12 hours prior to beginning wall construction. As in all construction the first course of wall panels will need to be placed carefully since any discrepancies and errors in alignment will continue throughout the wall. The panels will need to be checked that the correct panels are placed in the proper position, that they have the proper spacing, that there is adequate bracing of the panels and that the required spacers are placed.

Of special consideration the tilt of the panels will need to be verified. The integrity of the wall depends on the soil strap friction and the friction does not develop until a load (and subsequent slight movement) is applied. Since some movement will occur the panels are tilted inward, cambered at the top to accommodate some deflection outward. The proper tilt should be indicated on the shop drawings.

The joints between the panels are covered on the inside of the wall with a filter fabric. The fabric is held in place over the seams as the backfill is placed using an approved adhesive. The adhesive must be applied to the wall panels and not the fabric. Applying the adhesive to the

fabric will clog the pores in the fabric and defeat the purpose of using a porous fabric. The fabric will need to be properly stored and protected from UV light prior to installation.



Figure 10-4 Five Passes of Plate Compactor within 3' of Wall

### **BACKFILL**

The proper placement of the structural backfill type 3 is essential for the longevity and integrity of the wall. The fill needs to be placed in loose lifts of less than 8" in the area of reinforcement. This is reduced to 5" in the area within 3 feet of the wall panels. The backfill material shall be compacted using a roller in accordance with Section **409.03(d)4** with a

minimum 1000 vibrations per second. Within 3 feet of the wall the roller is not to be used. Compaction is done with a light weight mechanical means.

Figure 10-4 shows proper compaction within 3 feet of the wall. A minimum of 5 passes should be made to assure adequate compaction.



Figure 10-5 Proper Placement

The backfill material is not to be pushed into the wall. This will compromise the integrity of the wall as it will cause the panels to deflect outward before the reinforcement straps are capable of resisting the load of the material. Panels could be pushed out of alignment, straps could break, and the structure will not last the minimum 75 year design life. Push backfill parallel with the wall, and keep equipment a minimum of 3 ft from the wall to reduce load. The fill material is to be pushed out to the wall in stages using a dozer or other equipment along the length of the wall and not directly into the wall. Each lift of fill is not to be placed until the previous lift has been fully compacted, see Figure 10-5 and Figure 10-6.

### **REINFORCEMENT PLACEMENT**

The fill is to be brought up to the elevation of the reinforcement attachments before the straps are to be connected to the attachment point. A small amount is to be dug out from under the attachment point. The connecting bolt is placed from the bottom with the strap centered at the point. If the reinforcement straps are placed prior to the backfill material the compaction effort will pull the straps out of the designed horizontal position or possibly damage the straps or the connection points.

Figure 10-7 shows the proper method of attaching the straps to the wall panels. The nut should be on top.



Figure 10-6 Improper Placement

Other MSE wall systems may have a different strap/reinforcement connection – the same care should be followed to assure the straps are not overloaded prior to compaction of the fill material. Whichever system is used, follow the manufactures recommendations.

Construction equipment should not be operated on the reinforcement straps until the backfill material is in place and compacted. This shows the correct method of delivering the straps to the wall area. Also note the windrow of backfill material ready to be placed onto the reinforcement. You can see from the tracking that the equipment is operated longitudinally to the wall and not directly into it.

The reinforcement location in the fill needs to be carefully placed around any obstructions or other objects whose function requires location in the fill. Straps should never be cut or eliminated due to objects in the fill. If there is any questions of where to place the straps the designer of the wall should be contacted.



*Figure 10-7 Proper Strap Attachment*

### **REVIEW**

As the wall is built, watch for the following:

1. Is the proper compaction being met within 3 feet of the wall and greater than 3 feet from the wall based on DCP criteria?
2. Is the fill being brought up to or slightly above the soil reinforcement elevation before the reinforcement are connected?
3. Is the reinforcement being properly connected?
4. Is the soil reinforcement in the proper alignment?
5. Are the vertical and horizontal alignments checked periodically and adjusted as needed?
6. Is the Contractor removing the wooden wedges as per specification?
7. At the end of each day's operation, is the Contractor shaping the last level of backfill to permit a positive drainage away from the wall such as temporary pipe etc?
8. Has the Contractor backfilled the front of the wall?
9. Is the correct coping being installed?



*Figure 10-8 Reinforcement Strap Installation*

---

---

# CHAPTER ELEVEN: *AGGREGATE BASES*

---

---

Uncoated aggregate bases are classified as compacted aggregate bases or subbases. In general, subbases have a small amount of material passing the No. 200 sieve making the material a well-drained material. Compacted aggregate is denser than subbase. Aggregate bases provide additional strength for pavement sections and allow less capillary rise of moisture from paving subgrades, making them less susceptible to "frost heave" and "pumping". The location, width, and depths of aggregate bases are found in the typical cross-section sheets of the plans.

---

## **AGGREGATE BASE**

An aggregate base is a dense-graded compacted aggregate that is normally placed on a prepared subgrade in accordance with Section **105.03**. Materials used for aggregate bases are required to be size No. 53, Class D or Higher in accordance with Section **904**.

### ***PREPARATION OF SUBGRADE***

Subgrade is required to be compacted in accordance with Section **207.04**. In areas of 500 ft or less in length, or for temporary runarounds, proofrolling is not required. Proofrolling is also not required in trench sections where proofrolling equipment cannot be used.

### ***TEMPERATURE LIMITATIONS***

Aggregate is not placed when the air temperature is less than 35° F or on a frozen subgrade. Frozen aggregates may not be used.

### ***SPREADING***

The aggregate is required to be spread in uniform lifts with a spreading and leveling device approved by the PEMS. The spreading and leveling device is required to be capable of placing aggregate to the depth, width, and slope specified. The compacted depth of each lift is required to be a minimum of 3" and a maximum of 6" The aggregate is handled and transported to minimize segregation and the loss of moisture. In areas inaccessible to mechanical equipment, approved hand spreading methods may be used.

### ***COMPACTING***

Aggregates are required to be compacted according to Section **301.06**. Compaction is tested using a Light Weight Deflectometer. The aggregate is required to meet the compaction requirements at the time subsequent courses are placed. In areas inaccessible to compaction equipment, such as private drives, mailbox approaches, and temporary runarounds, the compaction requirements may be accepted by visual inspection.

Alternatively, aggregate shall be compacted to 100% of the maximum dry density in accordance with **AASHTO T 99**. All displacement or rutting of the aggregate is repaired prior to placing subsequent material.

### **CHECKING AND CORRECTING BASE**

The top of each course is checked transversely to the cross section. Deviations exceeding ½" are corrected. If additional aggregate is needed, the course is re-mixed and re-compacted.

### **METHOD OF MEASUREMENT**

Compacted aggregate base is measured by the ton in accordance with Section **109.01(b)**.

### **BASIS OF PAYMENT**

The accepted quantities of compacted aggregate base are paid for at the contract unit price per cubic yard, complete in place. The cost of placing, compacting, water, and necessary incidentals is included in the costs of the pay item. Payment is not made for material placed outside of a one-to-one slope from the planned typical section. Replacement of pavement damaged by the Contractor's operations is done at no additional payment. If the aggregate is placed as a subgrade treatment it is not paid as aggregate, but as subgrade treatment.

---

## **SUBBASE**

Subbase is a foundation course of selected materials, placed and compacted on a prepared subgrade in accordance with Section **105.03**. Subbase for PCCP consists of 3" of coarse aggregate No. 8 as the aggregate drainage layer placed over a 6" coarse aggregate No. 53 as the separation layer. Dense graded subbase consists of a 6" of coarse aggregate No. 53.

Coarse aggregate No. 8 used as an aggregate drainage layer is required to consist of 100% crushed stone or air cooled blast furnace slag and meet the requirements of Section **904**.

### **PREPARATION OF SUBGRADE**

Subgrade is required to be prepared in accordance with Section **207**.

### **TEMPERATURE LIMITATIONS**

Aggregate may not be placed when the air temperature is less than 35° F or on a frozen subgrade. Frozen aggregate may not be used.

### **SPREADING**

The aggregate is required to be spread in uniform lifts with a spreading and leveling device approved by the PEMS. The spreading and leveling device is required to be capable of placing aggregate to the depth, width, and slope specified. The compacted depth of each lift is a minimum of 3" and a maximum of 6". The aggregate is handled and transported to minimize segregation and the loss of moisture. In areas inaccessible to mechanical equipment, approved hand spreading methods may be used.

### **COMPACTING**

Subbases are required to be compacted as follows:

1. Aggregate Separation Layers and Dense Graded Subbase. Compaction is required to be in accordance with Section **301.06**.

2. Aggregate Drainage Layers. Compaction consists of two passes with a vibratory roller before trimming, and one pass with the same roller in static mode after trimming. A vibratory roller is required to be equipped with a variable amplitude system, a speed control device, and have a minimum vibration frequency of 1000 vibrations per min. A roller in accordance with Section **409.03(d)4** may be used.
3. In areas inaccessible to standard size compacting equipment, a specialty roller/compactor in accordance with Section **409.03(d) 6** may be used.

All displacement or rutting of the aggregate drainage layers is required to be repaired prior to placing subsequent material.

#### ***CHECKING AND CORRECTING SUBBASE***

The top of each course is checked transversely, and deviations exceeding ½" are corrected. If additional aggregate is required, the course is re-mixed and re-compacted.

#### ***METHOD OF MEASUREMENT***

Subbase for PCCP or dense graded subbase is measured by the cubic yard based on the theoretical volume to the neat lines as indicated on the plans. The quantity indicated in the Schedule of Pay Items is adjusted if the quantity is different by more than 2% of the measured quantity.

#### ***BASIS OF PAYMENT***

The accepted quantities of subbase for PCCP or dense graded subbase are paid for at the contract price per cubic yard, complete in place. The cost of compacting, water, aggregates placed outside neat lines as indicated on the plans, and necessary incidentals is included in the cost of the subbase.

---

## **AGGREGATE PAVEMENT OR SHOULDERS**

Aggregate pavements or shoulder require a dense-graded compacted aggregate which is placed on a prepared subgrade in accordance with Section **105.03**. Materials for this use are required to be No. 53 or No. 73 in accordance with Section **904**. A dust palative, if required, is to be in accordance with Section **407**.

#### ***PREPARATION OF SUBGRADE***

Subgrade is required to be compacted in accordance with Section **207.04**. In areas of 500 ft or less in length, or for temporary runarounds, proofrolling is not required. Proofrolling is also not required in trench sections where proofrolling equipment cannot be used.

#### ***TEMPERATURE LIMITATIONS***

Aggregate is not placed when the air temperature is less than 35° F or on a frozen subgrade. Frozen aggregates may not be used.

### ***SPREADING***

The aggregate is required to be spread in uniform lifts with a spreading and leveling device approved by the PEMS. The spreading and leveling device is required to be capable of placing aggregate to the depth, width, and slope specified. The compacted depth of each lift is a minimum of 3" and a maximum of 6". The aggregate is handled and transported to minimize segregation and the loss of moisture. In areas inaccessible to mechanical equipment, approved hand spreading methods may be used.

### ***COMPACTING***

Aggregates are required to be compacted according to the current specifications. Compaction is tested using a Light Weight Deflectometer. The aggregate is required to meet the compaction requirements at the time subsequent courses are placed. In areas inaccessible to compaction equipment, such as private drives, mailbox approaches, and temporary runarounds, the compaction requirements may be accepted by visual inspection. All displacement or rutting of the compacted aggregate is repaired prior to placing subsequent material.

### ***CHECKING AND CORRECTING BASE AND SURFACE***

The top of each aggregate course is checked transversely and all deviations in excess of ½" are corrected. If additional aggregate is required, the course is remixed and re-compacted.

### ***METHOD OF MEASUREMENT***

Compacted aggregate is measured by ton in accordance with Section **109.01(b)** for the type specified.

### ***BASIS OF PAYMENT***

The accepted quantities of compacted aggregate are paid for at the contract unit price per ton, for the type specified, complete in place. The cost of placing, compacting, water, and necessary incidentals is included in the costs of the compacted aggregate. Payment is not made for material placed outside of a one-to-one slope from the planned typical section. Replacement or repair of pavement or shoulders damaged by the Contractor's operations does not require additional payment.



---

# CHAPTER TWELVE: *LIGHT WEIGHT*

## *DEFLECTOMETER*

---

### OVERVIEW

Acceptance of the compaction of aggregate bases is determined by testing with a Light Weight Deflectometer, LWD. The LWD is used to determine the surface deflection resulting from an application of an impulse load. The resulting deflections are used to determine the stiffness of granular materials placed in embankments and aggregate subgrades.

The test procedure is described in **ITM 508**. The Contractor is required to keep the moisture content within the requirements of Section **203.23**. The district testing lab determines the compaction criteria from samples submitted to the lab. The lab results will include optimum moisture, maximum density, and gradation in accordance with **AASHTO T 99 Method C, T 11**, and **T 27** respectively. The minimum deflection required will be specified or determined based on a test section for each material type. When required, test sections are constructed in the presence of the Engineer and determine the roller type, pattern, and number of passes required to obtain the minimum required deflection.

Prior to construction of the test area, the subgrade should be proof rolled in accordance with Section **203.26**. See the contract documents for detailed instructions on the test strip.



Figure 12-1 A Lightweight Deflectometer

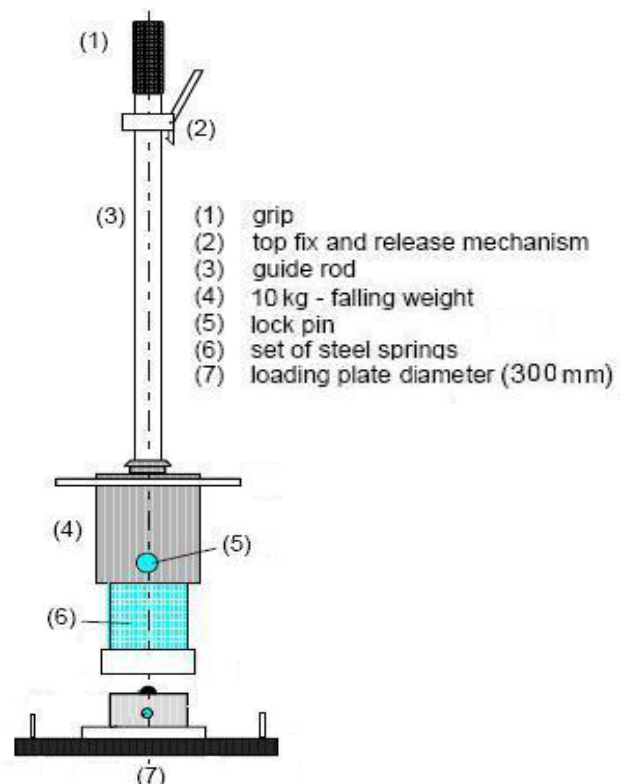

Figure 12-2 Breakdown of an LWD

---

## USING THE LIGHTWEIGHT DEFLECTOMETER

In general, the LWD test procedures are as follows:

1. The test area shall be leveled so that the entire undersurface of the load plate is in contact with the material being tested.
2. Any loose and protruding material should be removed. If required, any unevenness should be filled with fine sand.
3. The test should not be conducted if the temperature is below freezing.
4. The test area should be at least 1.5 times larger than the loading plate.
5. The loading plate should be seated in place by rotating it back and forth through about 45 degrees.
6. Hold the guide rod plumb.
7. Lift the weight to the release mechanism. Release the weight and catch it when it rebounds after striking the loading plate. Repeat this step 3 times to seat the plate.
8. Turn on the control box and press start.
9. The test will require 3 drops as prompted by the control box. Record the data for each drop in mm. The test is considered invalid if you fail to catch the rebounding weight or the plate moves laterally. If that happens, move the plate at least 2 feet away and repeat the full test sequence.
10. If the results vary by more than 10% for 2 consecutive drops the area will need additional compaction or additional drying. This will need to be done by the Contractor and the location retested.
11. The results should be recorded on the test form. Also, copy the results to the data card in the control box.
12. Calculate the average deflection of the 3 drops.
13. The average deflection will be recorded in mm.

# CHAPTER THIRTEEN: *DYNAMIC CONE PENETROMETER*

## OVERVIEW

The compaction of a cohesive soil is accepted based on strength of the soil as measured by a Dynamic Cone Penetrometer, DCP. The test is conducted in accordance with **ASTM D 6951**, using the 17.6 pound hammer. Currently the instructions for use of the DCP are in **ITM 509**. During the compaction of the fill and testing the moisture content is required to be within the limits shown in Section **203.23**. The criteria for DCP acceptance is also found in Section **203.23**.

## COMPONENTS & SETUP

The components of a DCP are shown in Figure 13-1.

The Division of Materials and Tests recommends using the disposable tips (Figure 13-2) to reduce damage to the DCP with it is removed from the embankment after the test is taken. Additional tips are available from District Testing or Central Materials.

Since the DCP test procedure counts the blows required for a given penetration, the easiest way to do this is by monitoring the depth with a series of marks along the stem of the DCP (Figure 13-3).

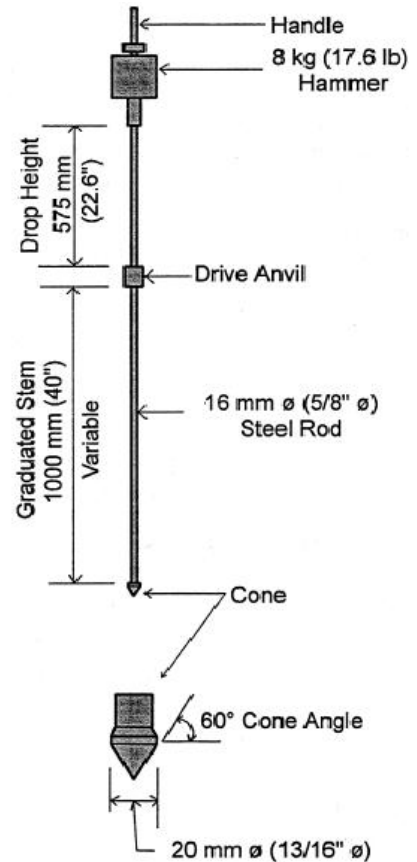

Figure 13-1 DCP Components



Figure 13-2 No Tip Installed (Top)  
Disposable Tip (Bottom)



Figure 13-3 Depth Marks

---

## USE OF THE DCP

1. The DCP is held vertically, by the handle.
2. The weight is lifted to the top of the DCP and cleanly dropped.
3. The number of blows required for a given penetration depth is recorded as the test result.
4. Pull straight up on the weight (Figure 13-4) towards the handle to remove the DCP from the ground – *do not rock* the DCP to aid removal.

Care should be taken when raising the weight to not to bump the handle too hard and displace the disposable tip from the bottom of the stem. Doing so could ruin the tip of the DCP.

A few things to remember when performing the DCP test:

- Representative samples of the soil from the jobsite or borrow pit needs to be taken and submitted to the District for sieve analysis and determination of liquid limit, plastic limit, optimum moisture content and maximum density. They will also provide you with a target blow count.
- If the DCP is bouncing and does not appear to be penetrating, the point may be bearing on a rock. If necessary, reset at a nearby location and conduct another test.
- For most tests, disposable cone points are recommended. The disposable cones cause less wear and tear on the DCP when it is being removed from the ground.
- If necessary, a 1-Point Proctor can be performed to determine the optimum moisture content if soil conditions have changed.



Figure 13-4 The Weight

---

---

# CHAPTER FOURTEEN: *FAMILY OF CURVES AND ONE-POINT PROCTOR PROCEDURES*

---

---

Highway embankments are composed of soil and/or aggregates placed in layers and compacted to an acceptable level. The purpose of a highway embankment is to provide adequate support of the overlying roadway and applied traffic loads. Section **203.23** discusses the methods of compaction control for embankment construction using most types of soils and aggregates. Subgrade compaction with density and moisture control requires compaction to 100% of the maximum dry density. Embankment compaction is accepted using the LWD and DCP rather than percentage of density. The Family of Curves and the One-Point Proctor procedure can be used for the determination of the optimum moisture content.

---

## MAXIMUM DRY DENSITY

Maximum dry density refers to the soil or aggregate density as determined in accordance with **AASHTO T 99**. **AASHTO T 99** sets forth a method of determining the density of a sample placed in layers in a certain size mold and compacted with a specified weight dropped from a specified height. The process is repeated on the same sample at various moisture contents. The resultant points are plotted on a chart of moisture content versus density. The maximum dry density and optimum moisture are found at the peak of the curve formed by joining the points.

---

## FAMILY OF CURVES

Repeating the compaction process for several different types of cohesive soils yields graphs (i.e. curves) of similar shape and geometry. These similar graphs plotted on one sheet are called the Family of Curves (see **AASHTO T 272**). A copy of the INDOT developed Family of Curves is kept on file in each District Testing Department. The Family of Curves may be used to estimate the maximum dry density and optimum moisture content of a cohesive soil sample in the field. **AASHTO T 99** is used to determine the values in a laboratory process.

Each layer of soil is required to be tested for compaction using either the LWD or DCP depending on the soil type, and moisture during embankment construction. In preparation for testing the soil, samples are taken from the jobsite cut areas or from proposed "borrow areas". By carefully observing the soil layers in a cut, the Technician may obtain samples of each soil type and submit those samples to District Testing. The samples are processed in accordance with **AASHTO T 99** and the maximum dry density and optimum moisture content of each sample is reported to the project in the form of a lab report.

The testing process works well if the embankment is constructed from just one soil type in each lift of embankment. However, the normal process is not nearly as well defined. Each embankment layer being placed may contain different portions of two or more types of the soils as sampled. Which optimum moisture content that is most representative of that specific lift of embankment may be difficult to determine.

---

## ONE-POINT PROCTOR

If the soil is cohesive in nature, the INDOT Family of Curves may be used. After the Technician has conducted a DCP test to determine the in-place compaction of an embankment layer, a representative sample of soil, approximately 7 pounds, is removed from the area around the test site. The maximum dry density and optimum moisture of the soil sample is determined using the one-point proctor method, **AASHTO T 272** Method A. The process involved is similar to that required in **AASHTO T 99**. The moisture of the sample is determined in accordance with **ITM 506**. The resulting wet density and actual field moisture content are plotted on the Family of Curves, the curve number line is followed to the maximum density line, the intersection point is then followed over to the turn line on the Maximum Wet Density vs Maximum Dry Density chart, the point at the intersection is followed down to the turn line on the Opt. Moisture Content vs Maximum Dry Density chart, then followed to the left to find the optimum moisture content.

The following example illustrates the use of the INDOT Family of Curves to select a maximum dry density and optimum moisture content for a density test.

### **EXAMPLE PROBLEM**

A sample of the soil is obtained from the area immediately surrounding the DCP test site. The sample size is required to exceed 7 pounds. A minimum of 2.2 pounds is required for the moisture test in accordance with **ITM 506** and approximately 4 to 5 pounds is necessary to produce the molded soil sample for the one-point proctor. This sample need not be protected from drying.

From the one-point proctor test, the following information was obtained.

A. Weight of prepared sample in the mold	9.93 lb
B. Weight of the one-point mold	5.40 lb
C. Net weight of Soil (A-B)	4.53 lb
D. $C \times 30 =$ Weight of one cubic foot	136.00 lb
E. <b>ITM 506</b> moisture content	6.5%

By plotting 136.0 lb/ft<sup>3</sup> on the vertical axis of the chart and 6.5% on the horizontal axis, the point falls between the first and second curve (Figure 14-1). A line between the curves is followed up to the turn line, then over to the 2<sup>nd</sup> chart and down to the maximum dry density of 131.0 pcf, then followed down to the turn line on the 3<sup>rd</sup> curve and over to the optimum moisture content of 8.8%. These values then become the target dry density and moisture content for the soil mixture being tested.

As previously mentioned, Section **203.23** requires that the moisture content during compaction be within the specified range.

The points plotted on the Family of Curves do not always plot directly onto one curve. For example, if the one-point proctor revealed a wet density of 131.0 lb/ft<sup>3</sup> and the moisture content results was 14.0%, plotting this pair of points on the chart would locate a point between Curve 9 and Curve 10. For this situation, the average of the curve data may be obtained to select the maximum dry density and optimum moisture content.

The moisture content used to plot on the Family of Curves is required to be between the optimum moisture and minus two percent of optimum moisture. If the plotted points fall outside of these limits, water may be added to the sample or the sample may be dried to allow the moisture to fall within the prescribed limits. The soil sample would then be recompacted in the one-point mold and a new wet density calculated and moisture obtained.

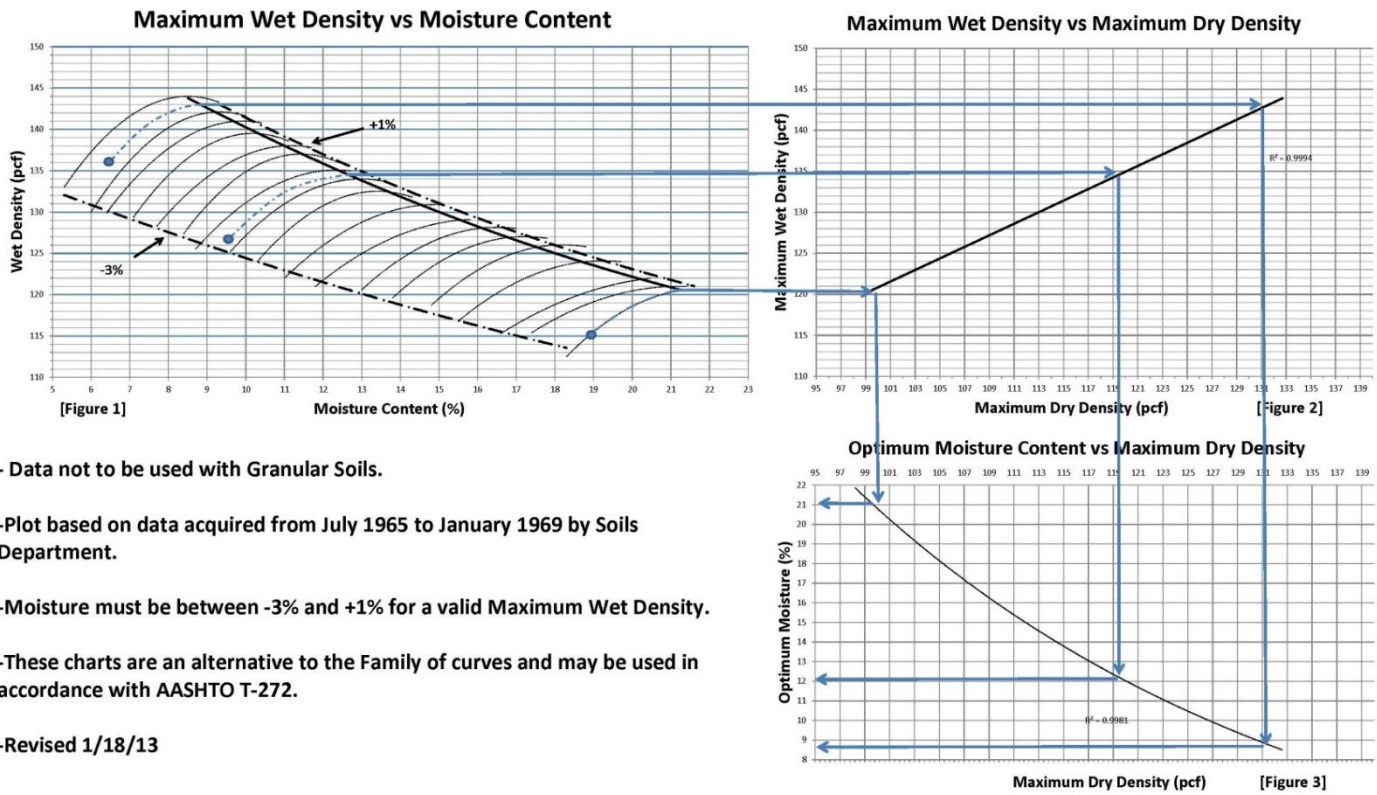

- Data not to be used with Granular Soils.
- Plot based on data acquired from July 1965 to January 1969 by Soils Department.
- Moisture must be between -3% and +1% for a valid Maximum Wet Density.
- These charts are an alternative to the Family of curves and may be used in accordance with AASHTO T-272.
- Revised 1/18/13

Figure 14-1 Typical Moisture Density Curves