

# Indiana Department of Transportation



CERTIFIED TECHNICIAN PROGRAM  
TRAINING MANUAL FOR



# Hot Mix Asphalt Paving



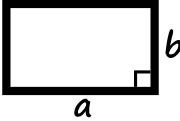
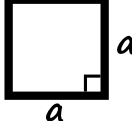

# MATH REFERENCES

1 foot = 12 inches      1 square foot = 144 square inches      1 cubic foot = 1728 cubic inches  
 3 feet = 1 yard      9 square feet = 1 square yard      27 cubic feet = 1 cubic yard  
 5280 feet = Mile      1760 yards = 1 mile      1 acre = 4840 square yards

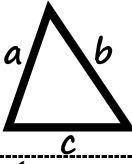
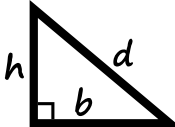
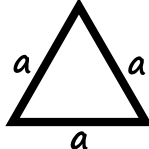
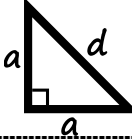
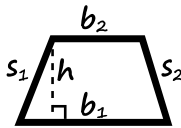
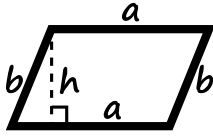
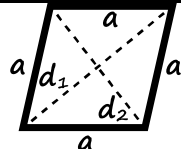
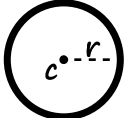
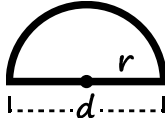
Rectangle		Square	
Perimeter	$2(a + b)$	Perimeter	$4a$
Area	$a \times b$	Area	$a^2$
Triangle		Triangle (any)	
Perimeter	$a + b + c$	Area by sides (no height)	$s = \frac{1}{2}(a + b + c)$
Area	$\frac{1}{2}(b \times h)$		$A = \sqrt{s(s - a)(s - b)(s - c)}$
Right Triangle		Equilateral Triangle	
Perimeter	$b + h + d$	Perimeter	$3a$
Area	$\frac{1}{2}(b \times h)$	Area	$\frac{\sqrt{3}}{4}a^2$
Isosceles Right Triangle		Trapezoid	
Perimeter	$2a + d$	Perimeter	$b_1 + b_2 + s_1 + s_2$
Area	$\frac{1}{2}a^2$	Area	$h \times \frac{b_1 + b_2}{2}$
Parallelogram		Rhombus	
Perimeter	$2(a + b)$	Perimeter	$4a$
Area	$a \times h$	Area	$\frac{d_1 \times d_2}{2}$
Circle		Semicircle	
Perimeter	$2\pi r$	Perimeter	$\pi r + 2r$
Area	$\pi r^2$	Area	$\frac{\pi r^2}{2}$

# AREA OF A CIRCULAR SEGMENT

$$\text{Area} = C \times b \times \text{coefficient}$$

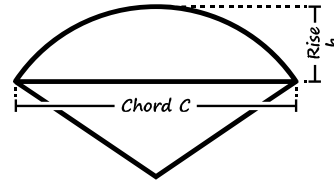

Coefficient	$\frac{b}{C}$
0.66667	0.00218
0.66668	0.00436
0.66669	0.00655
0.66671	0.00873
0.66673	0.01091
0.66676	0.01309
0.66679	0.01528
0.66683	0.01746
0.66687	0.01965
0.66692	0.02183
0.66697	0.02402
0.66703	0.02620
0.66710	0.02839
0.66717	0.03058
0.66724	0.03277
0.66732	0.03496
0.66740	0.03716
0.66749	0.03935
0.66759	0.04155
0.66769	0.04374
0.66779	0.04594
0.66790	0.04814
0.66802	0.05035
0.66814	0.05255
0.66826	0.05476
0.66839	0.05697
0.66853	0.05918
0.66867	0.06139
0.66882	0.06361
0.66897	0.06583
0.66913	0.06805
0.66929	0.07027
0.66946	0.07250
0.66964	0.07473
0.66981	0.07696
0.67000	0.07919
0.67019	0.08143
0.67039	0.08367
0.67059	0.08592
0.67079	0.08816
0.67101	0.09041
0.67122	0.09267
0.67145	0.09493
0.67168	0.09719
0.67191	0.09946

Coefficient	$\frac{b}{C}$
0.67215	0.10173
0.67240	0.10400
0.67265	0.10628
0.67291	0.10856
0.67317	0.11085
0.67344	0.11314
0.67372	0.11543
0.67400	0.11773
0.67429	0.12004
0.67458	0.12235
0.67488	0.12466
0.67519	0.12698
0.67550	0.12931
0.67582	0.13164
0.67614	0.13397
0.67647	0.13632
0.67681	0.13866
0.67715	0.14101
0.67750	0.14337
0.67786	0.14574
0.67822	0.14811
0.67859	0.15048
0.67897	0.15287
0.67935	0.15525
0.67974	0.15765
0.68014	0.16005
0.68054	0.16246
0.68095	0.16488
0.68136	0.16730
0.68179	0.16973
0.68222	0.17216
0.68265	0.17461
0.68310	0.17706
0.68355	0.17952
0.68401	0.18199
0.68448	0.18446
0.68495	0.18694
0.68543	0.18943
0.68592	0.19193
0.68642	0.19444
0.68692	0.19696
0.68743	0.19948
0.68795	0.20201
0.68848	0.20456
0.68901	0.20711

Coefficient	$\frac{b}{C}$
0.68956	0.20967
0.69011	0.21224
0.69067	0.21482
0.69123	0.21741
0.69181	0.22001
0.69239	0.22261
0.69299	0.22523
0.69359	0.22786
0.69420	0.23050
0.69482	0.23315
0.69545	0.23582
0.69608	0.23849
0.69673	0.24117
0.69738	0.24387
0.69805	0.24657
0.69872	0.24929
0.69941	0.25202
0.70010	0.25476
0.70080	0.25752
0.70151	0.26028
0.70223	0.26306
0.70297	0.26585
0.70371	0.26866
0.70446	0.27148
0.70522	0.27431
0.70600	0.27715
0.70678	0.28001
0.70758	0.28289
0.70838	0.28577
0.70920	0.28868
0.71003	0.29159
0.71087	0.29452
0.71172	0.29747
0.71258	0.30043
0.71345	0.30341
0.71434	0.30640
0.71524	0.30941
0.71615	0.31243
0.71707	0.31548
0.71800	0.31854
0.71895	0.32161
0.71991	0.32470
0.72088	0.32781
0.72187	0.33094
0.72287	0.33409

Coefficient	$\frac{b}{C}$
0.72388	0.33725
0.72491	0.34044
0.72595	0.34364
0.72701	0.34686
0.72808	0.35010
0.72916	0.35337
0.73026	0.35665
0.73137	0.35995
0.73250	0.36327
0.73364	0.36662
0.73480	0.36998
0.73598	0.37337
0.73717	0.37678
0.73838	0.38021
0.73960	0.38366
0.74084	0.38714
0.74210	0.39064
0.74337	0.39417
0.74466	0.39772
0.74597	0.40129
0.74730	0.40489
0.74865	0.40852
0.75001	0.41217
0.75140	0.41585
0.75280	0.41955
0.75422	0.42328
0.75566	0.42704
0.75713	0.43083
0.75861	0.43464
0.76011	0.43849
0.76164	0.44236
0.76318	0.44627
0.76475	0.45020
0.76634	0.45417
0.76795	0.45817
0.76959	0.46220
0.77125	0.46626
0.77293	0.47035
0.77463	0.47448
0.77636	0.47865
0.77812	0.48284
0.77990	0.48708
0.78171	0.49135
0.78354	0.49566
0.78540	0.50000

---

---

# MANUAL DISCLAIMER

---

---

The references in this manual are reflective of the 2024 INDOT Standard Specifications. The material covered herein is for training purposes only. The Standard Specifications, Contract Information Book, General Instruction to Field Employees, and Construction Memos should be consulted for determining the current inspection procedures for a given contract. On-site procedures, field tests, and other operating procedures may vary from those described within this manual.

---

---

## TABLE OF CONTENTS

---

---

<b>CHAPTER ONE: HOT MIX ASPHALT PAVEMENT .....</b>	<b>1-1</b>
TERMINOLOGY .....	1-1
ASPHALT .....	1-1
<i>Source and Nature of Asphalts</i> .....	1-2
HOT MIX ASPHALT.....	1-3
<i>Paving Courses</i> .....	1-3
<i>Open-graded and Dense-Graded Mixtures</i> .....	1-4
DESIGN MIX FORMULA .....	1-4
MIXING PROCESS.....	1-4
<i>Batch Plant Operations and Components</i> .....	1-5
<b>CHAPTER TWO: MIX COMPOSITION TYPES.....</b>	<b>2-1</b>
QC/QA HOT MIX ASPHALT PAVEMENT.....	2-1
<i>Quality Control Plan</i> .....	2-1
<i>Materials</i> .....	2-3
HOT MIX ASPHALT (HMA).....	2-5
<i>Hot Mix Asphalt Pavement</i> .....	2-5
QC/QA STONE MATRIX ASPHALT PAVEMENT.....	2-6
<b>CHAPTER THREE: PAVING EQUIPMENT .....</b>	<b>3-1</b>
DISTRIBUTORS.....	3-1
PAVERS.....	3-1
<i>Paver Components</i> .....	3-2
<i>Towed Screed</i> .....	3-2
<i>Paver Requirements</i> .....	3-3
<i>Paver Screed Controls</i> .....	3-3
<i>Spray Paver</i> .....	3-4
WIDENING MACHINES.....	3-4
COMPACTION EQUIPMENT .....	3-4
<i>Two-Axle Tandem Roller</i> .....	3-5
<i>Three-Wheel Roller</i> .....	3-5
<i>Pneumatic Tire Roller</i> .....	3-5

<i>Vibratory Roller</i> .....	3-6
<i>Oscillatory Roller</i> .....	3-6
<i>Trench Roller</i> .....	3-6
MATERIAL TRANSFER VEHICLES .....	3-6
HAUL TRUCKS .....	3-7
HAND TOOLS .....	3-7
<b>CHAPTER FOUR: PREPARATION OF SURFACE</b> .....	<b>4-1</b>
SUBGRADE TREATMENT .....	4-1
PROOFROLLING .....	4-1
MILLING .....	4-1
PATCHING .....	4-2
WEDGE AND LEVEL .....	4-3
SURFACE CLEANING .....	4-4
TACK COAT .....	4-4
<i>Application</i> .....	4-4
<i>Breaking and Setting</i> .....	4-5
PRIME COAT .....	4-6
<b>CHAPTER FIVE: MIX PLACEMENT AND COMPACTION</b> .....	<b>5-1</b>
WEATHER LIMITATIONS .....	5-1
TEMPERATURE AND APPEARANCE AT POINT OF DELIVERY .....	5-2
PAVING OPERATION .....	5-2
<i>Screed Control</i> .....	5-2
<i>Start-Ups</i> .....	5-5
<i>Transverse Joints</i> .....	5-5
<i>Longitudinal Joints</i> .....	5-6
<i>Safety Edge</i> .....	5-6
<i>Compaction</i> .....	5-6
ASPHALT EMULSION STRUCTURAL TREATMENTS .....	5-9
<i>Joint Sealant</i> .....	5-9
<i>Joint Adhesive</i> .....	5-10
<b>CHAPTER SIX: THICKNESS AND TONNAGE CONTROL</b> .....	<b>6-1</b>
MIXTURE ADJUSTMENT FACTOR .....	6-1
DETERMINING COURSE THICKNESS .....	6-2
DEPTH CHECKS .....	6-3
ACTUAL RATE OF SPREAD .....	6-3
<i>Stationing</i> .....	6-3
<i>Weigh Tickets</i> .....	6-4
<i>Computing Rates of Spread</i> .....	6-4
<b>CHAPTER SEVEN: QUALITY ASSURANCE PROCEDURES AND SAMPLING</b> .....	<b>7-1</b>
DESIGN MIX FORMULA .....	7-1

LOTS AND SUBLOTS .....	7-1
<i>QC/QA HMA</i> .....	7-1
<i>QC/QA SMA</i> .....	7-1
QC/QA SAMPLE TYPES .....	7-2
<i>Plate Samples</i> .....	7-2
<i>Core Samples</i> .....	7-2
<i>Appeal Samples</i> .....	7-2
<i>Truck Samples</i> .....	7-3
ACCEPTANCE SAMPLING PROCEDURES .....	7-3
<i>Random Numbers</i> .....	7-3
<i>Plate Samples</i> .....	7-4
<i>Core Sampling</i> .....	7-9
<i>The Field Assistant HMA Tracker</i> .....	7-12
<b>CHAPTER EIGHT: HMA PAVING CHECKLISTS .....</b>	<b>8-1</b>
HAUL TRUCK CHECKLIST .....	8-1
SURFACE PREPARATION CHECKLIST .....	8-1
HMA PLACEMENT CHECKLIST .....	8-1
COMPACTION CHECKLIST .....	8-2





---

---

# CHAPTER ONE: *HOT MIX ASPHALT PAVEMENT*

---

---

This manual will provide information and guidance to Technicians regarding how to properly inspect Hot Mix Asphalt (HMA) paving operations. Furthermore, this manual promotes contract compliance between the Department and the Contractor.

A quality pavement requires materials and construction practices in accordance with the design and specifications for the pavement. Technicians are responsible for the quality and are required to know how a typical pavement is constructed and the related specifications to achieve a long-lasting pavement. Paving deficiencies found by the Technician must be reported to the Primary PEMS (Project Engineer/Manager/Supervisor).

---

## TERMINOLOGY

HMA has numerous synonyms, from bituminous paving mix, bituminous concrete, bituminous mix, asphalt paving mix, asphalt mix, asphaltic concrete, to simply "asphalt" among other terms. This manual uses "hot mix asphalt" to standardize the wording and minimize confusion. When the Standard Specifications are referenced in the manual, *QC/QA HMA* is used for mixtures in accordance with Section **401**, *HMA* is used for mixtures in accordance with Section **402**, and *SMA* is used for mixtures in accordance with Section **410**.

Asphalt materials include Performance Graded (PG) Asphalt Binders, Asphalt Emulsions, Cutback Asphalt, Utility Asphalt, and Asphalt used for coating corrugated metal pipe. Hot mix asphalt used for Department specified pavements requires PG binders for the asphalt material. This manual uses the term *binder* when referring to this material.

---

## ASPHALT

Asphalt is a black cementing material that varies widely in consistency from solid to semisolid at normal air temperatures. When heated sufficiently, asphalt softens and becomes a liquid, which allows it to coat the aggregate during HMA production.

Asphalt is mostly made of hydrocarbons called bitumen. Virtually all asphalt used in the United States is produced by modern petroleum refineries and is called petroleum asphalt. The degree of control allowed by modern refinery equipment permits the production of asphalts with specific characteristics suited to specific applications. As a result, different asphalts are produced for paving, roofing and other special uses.

Paving asphalt, commonly called binder, is a highly viscous, sticky material, and is an excellent cement for binding together aggregate particles in HMA as it adheres readily to aggregate. It is an excellent waterproofing material, resistant to most acids, alkalis and salts. As such, properly constructed HMA pavement is waterproof and resistant to many types of chemical damage.

Binder for paving may also contain modifiers to improve performance properties. Some of these binders require special storage and handling. The material suppliers' recommendations should be followed to ensure that these performance characteristics are not altered or lost before mixing and placement of the HMA.

Binder changes when the material is heated and/or aged. Binder tends to become hard and brittle and therefore loses some of its ability to adhere to aggregate particles. These changes may be minimized by understanding the properties of the binder and taking steps during construction to ensure that the finished pavement is built in a way that retards the aging process.

### **SOURCE AND NATURE OF ASPHALTS**

Because asphalt is used for many purposes, there is sometimes confusion about where asphalt comes from, how the material is refined, and how the material is classified into grades. There is similar confusion about terms related to asphalt properties and use.

#### **Petroleum Refining**

Crude petroleum is refined by distillation, a process in which various fractions (products) are separated out of the crude. Distillation is accomplished by raising the temperature of the crude petroleum in stages. As shown in Figure 1-1, different fractions separate at different temperatures.

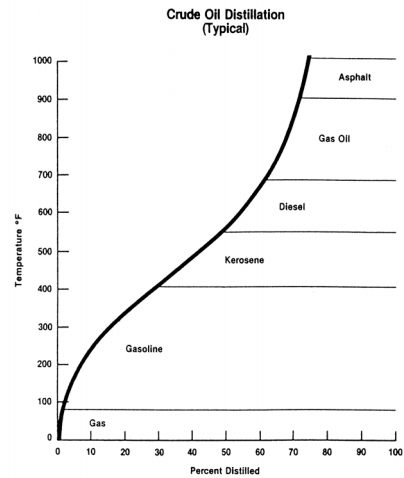

Figure 1-1 Typical Distillation Temperatures and Products

The lighter fractions are separated by simple distillation. The heavier distillates, often referred to as gas oils, may be separated only by a combination of heating and applying a vacuum. The product which cannot be distilled under vacuum distillation is asphalt.

Figure 1-2 is a schematic illustration of a typical refinery. The schematic shows the flow of petroleum during the refining process.

#### **Asphalt Refining**

Different types of asphalt are required for different applications. To produce asphalts that meet specific requirements, refiners are required to have a way to control the properties of the asphalts they produce. This is often accomplished by blending crude petroleum of various types together before processing. Blending allows refiners to combine crudes that contain asphalts of varying characteristics in such a way that the final product has exactly the characteristics required by the asphalt user.

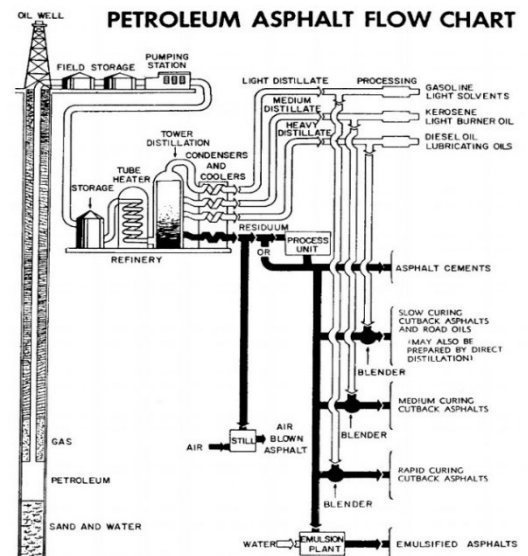

Figure 1-2 Typical Refining Process

Once the crude petroleum has been blended, there are two widely used processes by which asphalt may be produced from them: vacuum distillation and solvent extractions.

As discussed above, vacuum distillation involves separating the asphalt from the crude by applying heat and a vacuum. In the solvent extraction process, additional gas oils are removed from the crude, leaving residual asphalt.

### **Performance Graded Binder**

The binder specifications are based on fundamental properties which are measured at actual in service temperatures where the critical distresses occur. The upper temperature extreme is designated as the average 7-day maximum pavement design in degrees Celsius. This temperature is obtained by accumulating the temperature from each successive 7-day period throughout the summer, and choosing the 7-day period which yields the largest average. The lower temperature extreme is designated as the minimum pavement design temperature in degrees Celsius. An example of how this grading system works is shown in Figure 1-3. The specification limits for the PG Binders are listed in Section **902.01**.

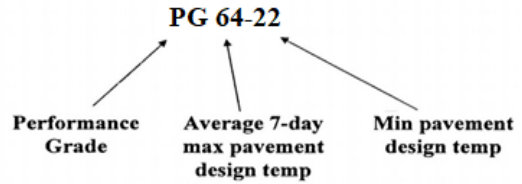

Figure 1-3 PG Grading System

---

## **HOT MIX ASPHALT**

Hot mix asphalt is a combination of two basic ingredients: asphalt and aggregates. Asphalt accounts for 3-8% of the mixture by weight, while the remaining 92-97% is aggregate.

### **PAVING COURSES**

A typical HMA pavement is comprised of three distinct HMA layers, known as courses: base, intermediate and surface.

#### **Base Course**

The base course is a foundation layer consisting of larger crushed aggregate sizes to provide stability and strength to the overall pavement. This course provides the bulk of the pavement structure and one of its main purposes is to distribute the traffic loads. Base courses are usually placed on treated subgrades but occasionally they are used for structural overlays, being placed in three or more lifts on an existing pavement that has been milled.

#### **Intermediate Course**

The intermediate course is a transitional layer of medium-sized crushed aggregate which act as a barrier to keep surface material from being pushed into the base material. Intermediate courses are typically placed on underlying base courses or a milled pavement for functional overlays in two lifts. Intermediate materials may qualify to be used as a base when designated as such in their mix design and are often used as a wedging and leveling course.

#### **Surface Course**

The surface course, also referred to as the wearing course, is the layer in direct contact with traffic loads and generally contains the highest quality of asphalt with smaller crushed aggregates. It provides features such as friction, smoothness, noise control, and rut and shoving resistance. Surface courses are usually placed on underlying intermediate courses or, for mill-and-fill operations, on a milled pavement surface.

## **OPEN-GRADED AND DENSE-GRADED MIXTURES**

HMA mixtures may also be open-graded or dense-graded mixtures.

### ***Open-Graded Mixtures***

Open-graded HMA mixtures usually consist of larger crushed aggregates with a minor percentage of small aggregates or fines. The open structure of the mix permits water to flow through the pavement. One use of this mix is to provide a free draining base course. If open-graded mixtures are specified, a dense-graded base mixture is needed under the open-graded layer, and underdrains must be included in the design.

### ***Dense-Graded Mixtures***

Dense-graded mixtures contain more small and fine aggregates to close up spaces between the larger aggregates. Dense-graded mixtures shed water from the surface better, providing a smoother ride, noise controlling, and are typically used for base, intermediate, or surface courses not requiring free drainage.

---

## **DESIGN MIX FORMULA**

Precise proportions of asphalt and aggregates are blended to produce HMA paving mixtures. The types of asphalt used, and the proportions of each component vary among mixtures. As a result, each mix has a different set of characteristics and properties.

Prior to paving, a Contractor will develop and submit a Design Mix Formula, or *DMF*, they anticipate using to District Testing for acceptance. A DMF specifies the types and proportions of binder and aggregates used to produce the mix and is available for review to Construction personnel via the *DMF Entry* application. A DMF may not be used on the contract until the DMF has been both accepted by District Testing and assigned to the corresponding Contract Item by the Contractor in DMF Entry.

The Technician is required to know what the pay item description is for each mix used. The pay item description indicates whether the mixture is QC/QA HMA in accordance with Section **401**, HMA in accordance with Section **402**, or SMA in accordance with Section **410**, alongside other mix features.

The PEMS will receive a notification when a DMF is assigned to an item on their Contract. DMFs can be reviewed directly in the DMF Entry application in ITAP by the HMA Technician, who is required to verify the materials being used to produce the mix that is being installed on a Contract Item each day.

---

## **MIXING PROCESS**

A HMA plant is an assembly of mechanical and electronic equipment where aggregates are blended, heated, dried, and mixed with binder to produce HMA meeting specified requirements. The plant may be stationary (located at a permanent location) or portable (moved from contract to contract). There are numerous types of plants, including batch plants, continuous mix plants, parallel-flow drum plants, counter flow drum plants, and double barrel

drum plants to name a few. In general, however, a majority of plants may be categorized as either batch plants (Figure 1-4) or drum mix plants (Figure 1-5).

Batch plants are labeled thusly as the HMA is produced in smaller batches and mixed as it is dispensed into trucks or a storage bin, in contrast to Drum plants which mix much larger quantities of HMA in a drum prior to being stored for dispersal. The size of a batch varies according to the capacity of the plant pugmill, which is the plant's mixing chamber where aggregate and binder are blended. A typical batch is approximately 6000 lb.

### BATCH PLANT OPERATIONS AND COMPONENTS

At a batch plant, aggregates are blended, heated and dried, proportioned, and mixed with binder to produce HMA. A plant may be small or large, depending on the type and quantity of HMA being produced, and also may be stationary or portable. Figure 1-6 illustrates the sequence of these operations.

Certain basic operations are common to all batch plants:

1. Aggregate storage and cold feeding
2. Aggregate drying and heating
3. Screening and storage of hot aggregates
4. Storage and heating of binder
5. Measuring and mixing of binder and aggregate
6. Loading of finished HMA

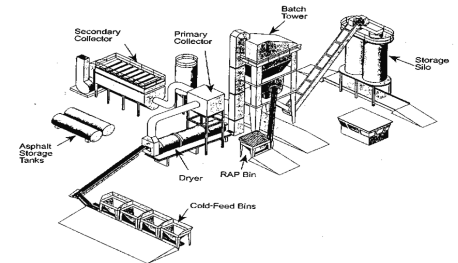

Figure 1-4 Typical Batch Plant

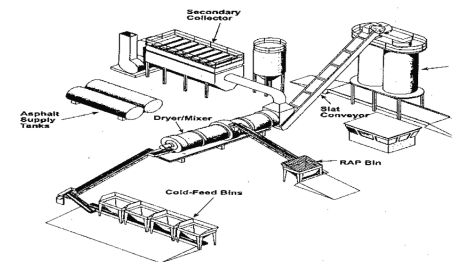

Figure 1-5 Typical Drum Plant

Aggregates are removed from storage or stockpiles in controlled amounts and passed through a dryer to be dried and heated. The aggregates then pass over a screening unit that separates the material into different sized fractions and deposits them into bins for hot storage. The aggregates and mineral filler, if applicable, are withdrawn in controlled amounts, combined with binder, and thoroughly mixed in a batch. The HMA is loaded directly into trucks, or placed in a surge bin, and hauled to the paving site.

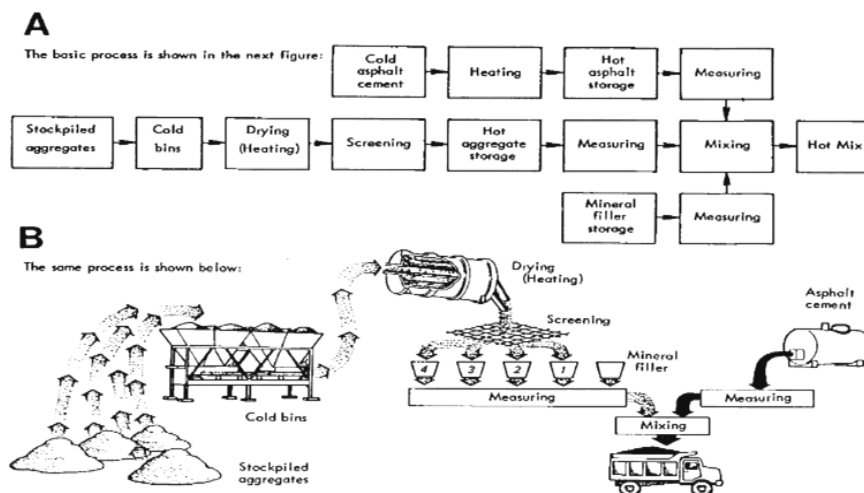

Figure 1-6 Basic Batch Plant Operations

Figure 1-7 illustrates the major components of a typical batch plant. The following overview of the processes involved in plant operations should help the Technician understand the functions and relationships of the various plant components:

Cold (unheated) aggregates stored in the cold bins (1) are proportioned by cold-feed gates (2) on to a belt conveyor or bucket elevator (3), which delivers the aggregates to the dryer (4), the aggregate is dried and heated. Dust collectors (5) remove undesirable amounts of dust from the dryer exhaust. Remaining exhaust gases are eliminated through the plant exhaust stack (6). The dried and heated aggregates are delivered by hot elevator (7) to the screening unit (8), which separates the material into different sized fractions and deposits them into separate hot bins (9) for temporary storage. When needed, the heated aggregates are measured in controlled amounts in to the weigh box (10). The aggregates are then dumped into the mixing chamber or pugmill (11), along with the proper amount of mineral filler, if needed, from the mineral filler storage (12). Heated binder from the hot binder storage tank (13) is pumped into the binder weigh bucket (14) which weighs the binder prior to delivery into the mixing chamber or pugmill where the binder is combined thoroughly with the aggregates. From the mixing chamber, the HMA is deposited into a waiting truck or delivered by conveyor into a surge bin.

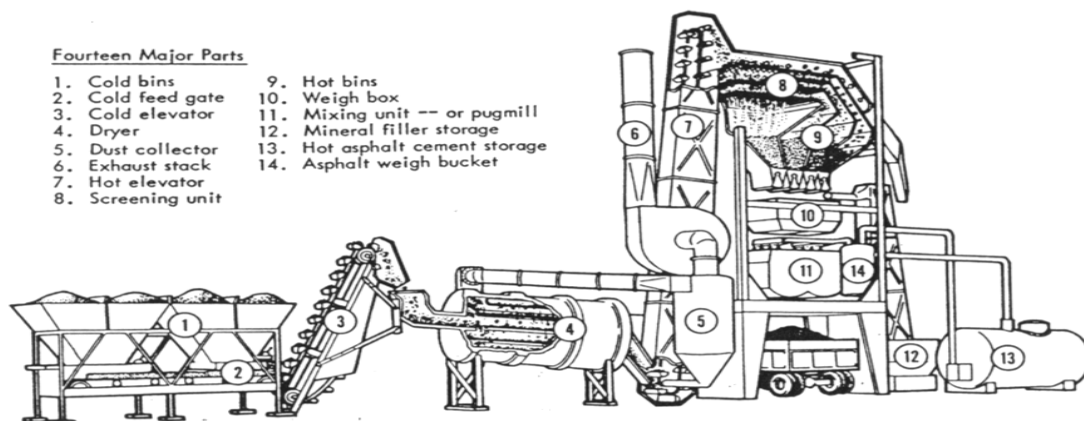

Figure 1-7 Major Batch Plant Components

### **Drum Plants**

Drum mixing is a relatively simple process of producing HMA. The difference between drum mix plants and batch plants is that, in drum mix plants, the aggregate is not only dried and heated within the drum but also mixed with the binder. There are no gradation screens, hot bins, weigh hoppers, or pugmills - aggregate gradation is controlled at the cold feed.

As the aggregates, which have been correctly proportioned at the cold feed, are introduced into the drum mix plant for drying, the binder is also added into the drum. The rotation and angle of the drum provide the mixing action that thoroughly blends the binder into the aggregates. As the HMA is discharged from the drum, the mixture is carried to one or more on-site surge bins, and subsequently loaded into trucks.

## Drum Mix Plant Components

The fundamental components of the drum mix plant are:

1. Aggregate cold-feed bins
2. Conveyor and aggregate weighing system
3. Drum mixer
4. Dust collection system
5. Hot mix conveyor
6. Mix surge bin
7. Control van
8. Binder storage tank

Figure 1-8 illustrates the major components of a typical drum mix plant. The following overview of the processes involved in plant operations should help the technician understand the functions and relationships of the various plant components:

Controlled gradations of aggregates are deposited in the cold feed bins (1) from which the aggregates are fed in exact proportions onto a cold-feed conveyor (2). An automatic aggregate weighing system (3) monitors the amount of aggregate flowing into the drum mixer (4). The weighing system is interlocked with the controls on the binder storage pump (5), which draws binder from a storage tank (6) and introduces binder into the drum where binder and aggregate are thoroughly blended by the rotating action of the drum. A dust collection system (7) captures excess dust escaping from the drum. From the drum, the HMA is transported by hot mix conveyor (8) to a surge bin (9) from which the mixture is loaded into trucks and hauled to the paving site. All plant operations are monitored and controlled from instruments in the control van (10).

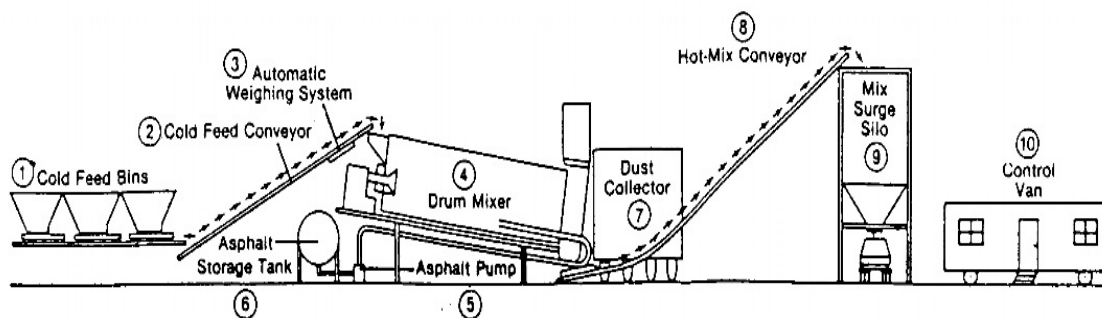

Figure 1-8 Basic Drum Mix Plant

The mixing process is essentially similar in all drum mixing plants; however, there are several plant designs available. These include the counter-flow drum, which has the burner located near the outlet end of the drum, and the unitized counter-flow drum, which has an outer mixing drum that surrounds the dryer drum.





---

---

## CHAPTER TWO: *MIX COMPOSITION TYPES*

---

---

A HMA pavement is composed of distinct courses of layered binder and aggregate blends. The individual material properties of each component may affect the overall performance of the pavement. If pavements are to perform long term and withstand specific traffic and loading, the materials making up the pavements are required to be of high quality.

The primary mix compositions specified by INDOT are:

**SS 401**, Quality Control/Quality Assurance, or QC/QA, Hot Mix Asphalt Pavement

**SS 402**, Hot Mix Asphalt Pavement

**SS 410**, Quality Control/Quality Assurance, or QC/QA, Stone Matrix Asphalt Pavement

The main difference between QC/QA and non-QC/QA mix is acceptance requirements.

---

### QC/QA HOT MIX ASPHALT PAVEMENT

Quality control/quality assurance hot mix asphalt pavement, or QC/QA HMA, sometimes referred as 401 mix, consists of base, intermediate or surface mixtures in large installations. The Contractor is responsible for Quality Control, or QC, of all phases of asphalt operations per Section **401**. This Section also includes the tolerances that are required to be met by the Contractor during the production and paving operations. To ensure that the Contractor's QC procedures provide a finished product within defined tolerances and expectations, the Department uses corresponding Quality Assurance, or QA, procedures. These procedures are designed to randomly sample material being placed by the contractor, as well as provide inspection of the Contractor's QC processes. The QA process consists of a number of tests used to ensure mix consistency and adherence to the accepted Design Mix Formula.

In general, QC/QA SMA follow the same principles as QC/QA HMA as expressed in the following sections. Additional information on QC/QA SMA and its differences from QC/QA HMA can be found at the end of this chapter.

#### **QUALITY CONTROL PLAN**

The contract specific phases that the Contractor intends to use in the paving operations to ensure the construction of a quality pavement are included in the Quality Control Plan, or *QCP*. In general, these phases include the methods of operation for activities such as mix placement, grade control, compaction, and sampling. The Contractor cannot begin paving operations until the QCP is approved by the PEMS. The QCP is required to be prepared in accordance with **ITM 803** and submitted by the Contractor in accordance with Section **401.02**. The QCP shall be submitted to the Engineer at least 15 days prior to commencing HMA paving operations.

It is the Technician's duty, and to their advantage, to review the Contractor's QCP initially and periodically to determine if paving operations are being performed per their plan. If the Contractor is performing work contrary to their QCP, attempt to resolve the discrepancy as soon as possible and notify the PEMS. Keep in mind that the QCP can be revised by an addendum. The current approved version of the QCP remains in effect until an addendum is approved. Do not allow proposed changes to be implemented until an addendum is approved.

## **Quality Assurance Procedures Overview**

QA procedures require both plate and core samples to be taken during paving operations, which are subsequently sent in for testing. Sampling procedures and additional information can be found in [Chapter Seven: Quality Assurance Procedures and Sampling](#). QA test results are distributed for volumetric properties and density via the *HMA Pay Wizard* application. These are made available as the Contractor enters corresponding QC test results and are available to Construction users with Contract Authority on a given Contract.

### **Plate Samples**

Plate samples are used to determine the following volumetric properties:

1. Asphalt Binder Content
2. Air Voids
3. Volume of Effective Binder

#### **ASPHALT BINDER CONTENT**

Asphalt binder content affects HMA pavement performance in the areas of stiffness, strength, durability, raveling, rutting, and moisture damage.

Per **ITM 571 Asphalt Content by Extraction**, the HMA plate sample is processed with a suitable solvent to determine asphalt content. This is calculated by determining the difference between the initial mass of the HMA mixture and the mass of the remaining extracted components: aggregate, fibers (if used), and fines recovered from the solvent and water rinse.

#### **AIR VOIDS**

Air voids are small pockets of air between coated aggregate in the compacted asphalt mixture. A specified minimum percentage of air voids is needed to prevent pavement from flushing, shoving, or rutting. High air voids shorten pavement life via accelerated aging.

By analyzing HMA core samples, the bulk specific gravity and maximum specific gravity of the asphalt mixture are determined, and the air voids are subsequently calculated.

#### **VOLUME OF EFFECTIVE BINDER**

The Volume of Effective Binder, or  $V_{be}$ , is calculated as the mixture VMA minus the mixture Air Voids. VMA (Voids in Mineral Aggregate) is the volume of void space between aggregate particles of a paving mixture including the air voids, and  $V_{be}$  is expressed as a percent of the total volume of a sample. Adequate  $V_{be}$  is needed to ensure an acceptable amount of asphalt was added to the mixture, without under- or overfilling voids.

$V_{be}$  is also determined by bulk specific gravity, or  $G_{sb}$ , of the aggregate and is expressed as a percentage of the volume of the mix.

### **Core Samples**

Core samples are taken to determine the in-place density of a paved course. Density is determined by determining the maximum specific gravity, or  $G_{mb}$ , in relation to an established  $G_{sb}$ . The density for the mixture is expressed as the percentage of the  $G_{mb}$ , or compaction percentage, determined by dividing the  $G_{sb}$  by the  $G_{mb}$ .

## ***Smoothness***

Pavement smoothness is another quality assurance parameter. Depending on the contract, the profile may be measured by use of a profilograph or inertial profiler. Exempt segments unsuitable for measurement by profilograph are verified with a 16 ft straightedge. Contracts utilizing an inertial profiler to measure smoothness will include corresponding testing and evaluation methods within the contract CIB. Inertial Profilers measure the consistency of pavement in both wheel paths to determine the IRI, or International Roughness Index.

On contracts that do not include a corresponding profilograph or IRI pay item, all longitudinal profiling of constructed pavement is verified with the 16 ft straightedge. The 16 ft straightedge shall be a rigid beam mounted on two solid wheels on axles 16 ft apart. The straightedge has a mounted push bar to facilitate propelling the device along or across the pavement. Tolerance points are located at the  $\frac{1}{4}$ ,  $\frac{1}{2}$ , and  $\frac{3}{4}$  points and should be composed of threaded bolts to allow adjustment to required tolerances. At locations where the 16 ft straightedge is used, pavement variations shall be corrected to  $\frac{1}{4}$ " or less.

Regardless of the instrument used to measure the longitudinal profile, a 10 ft straightedge is used to verify the transverse slopes perpendicular to mainline direction, including longitudinal profiles of public road approaches and median crossovers. At locations where the 10 ft straightedge is used, the pavement variations shall be corrected to  $\frac{1}{8}$ " or less.

Smoothness is checked either by profilograph or inertial profiler, operated by the Contractor, or straightedge, operated by the Department. An INDOT representative should be present to observe profilograph operations.

## ***MATERIALS***

All QC/QA HMA mixtures are required to be produced by a certified HMA plant in accordance with **ITM 583**.

### ***Pay Item Description***

QC/QA HMA pay items have a standardized format that provides information about the type of material required.

For example, a **QC/QA-HMA, 3, 70, Surface 9.5 mm** pay item provides the following information:

1. "**QC/QA-HMA**" represents Quality Control, Quality Assurance Hot Mix Asphalt
2. The "**3**" reflects the ESAL category for the mixture, a classification of a volume range of anticipated truck traffic on a roadway. Higher ESAL categories represent higher expected truck volumes, so higher ESAL category mixtures require more durable aggregate and binder mixes to carry the anticipated loads.
3. The "**70**" reflects the PG binder grade required for the mixture. Typical PG binder grades that appear in pay item descriptions include 64, 70, and 76. Larger numbers indicate stiffer binders, typically required at locations subjected to higher loads or where higher temperatures are anticipated. PG 70 and PG 76 are primarily used in upper pavement courses and are more common in the southern regions of the State. PG 76 binders are also used in open graded mixtures to prevent draindown.
4. "**Surface**" indicates the mixture course or layer.

- "9.5 mm" identifies the mixture designation, or nominal aggregate size used. Nominal aggregate sizes for dense graded mixtures are 4.75 mm, 9.5 mm, 12.5 mm, 19.0 mm and 25.0 mm. Opened-graded mixtures allow for 9.5 mm, 19.0 mm and 25.0 mm nominal aggregate sizes. Mixtures with larger mix designations utilize larger aggregate. The maximum particle size in a mixture is larger than the nominal aggregate designation – see Section 401.05 for gradation range information

**Recycled Asphalt Pavement**

QC/QA HMA mixtures may also include recycled asphalt pavement, or *RAP*, as shown in Figure 2-1. RAP is primarily processed roadway millings. A mix's maximum RAP amount is determined by the course and ESAL category. The amount of RAP included in each mixture is identified in its DMF.



Figure 2-1 Recycled Asphalt Pavement

**Recycled Asphalt Shingles**

QC/QA HMA mixtures may also include recycled asphalt shingles, or *RAS*, obtained from the waste from a shingle manufacturing or from post-consumer (tear-off) shingles (Figure 2-2). Similar restrictions to allowable RAP exist also for RAS, based on the course and ESAL category. The amount of RAS included in each mixture is identified in its DMF. RAS and RAP may be used together in a HMA mixture.



Figure 2-2 Recycled Asphalt Shingles

**Binder Replacement**

The amount of RAP, RAS, or a combination of both that is allowed in HMA is based on the amount of binder in these recycled materials. Rather than specifying a maximum percentage of these recycled materials in the mixture, the amount of binder replacement of the virgin asphalt in the mixture is specified. The limits of the binder replacement in the mixture are specified in Section 401.06. Figure 2-3 is a graphical representation of how the binder replacement requirement is applied.

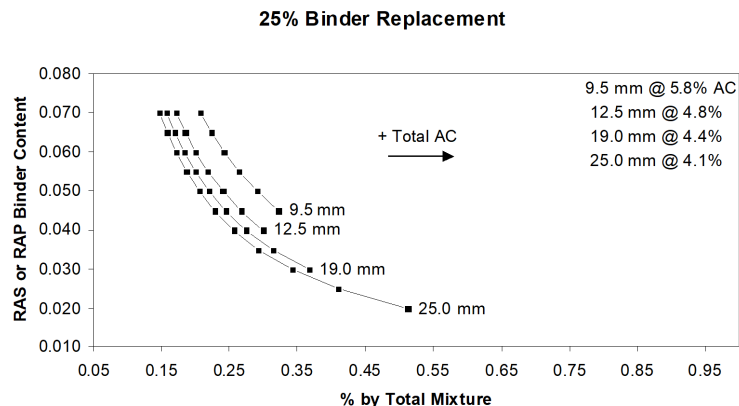

Figure 2-3 Binder Replacement

The amount of total binder replaced by binder in the recycled material is computed as follows:

$$\text{Binder Replacement, \%} = \frac{(A \times B) + (C \times D)}{E}$$

Where:

A = RAP, % Binder Content by Mass of Rap

B = RAP, % by Total Mass of Mixture

C = RAS, % Binder Content by Mass of RAS

D = RAS, % by Total Mass of Mixture

E = Total % Binder Content by Total Mass of Mixture

### ***Design Mix Formula***

The Contractor submits a DMF for each HMA mixture to District Testing via *DMF Entry* in ITAP. **ITM 583**, Certified Hot Mix Asphalt Producer Program, is the primary document that includes requirements related to the development of the DMF. The DMF includes the following information related to the mix design:

1. Producer (Contractor)
2. Plant Location
3. Material Identification and Sources of PG Binder and coarse and fine aggregate
4. DMF number
5. Applicable ESAL Categories
6. Mixture Course and Nominal Aggregate Designation
7. Gradation Information
8. Specific Gravity
9. Lab and Plant Mixture Temperatures
10. RAP/RAS Content
11. Volumetric Properties
12. Mixture Adjustment Factor, MAF
13. Other Miscellaneous Design Information

---

## **HOT MIX ASPHALT (HMA)**

### ***HOT MIX ASPHALT PAVEMENT***

Hot mix asphalt pavement, also known as *non-QC/QA HMA* or *402 mix*, are base, intermediate, or surface mixture placements in lower quantities, and as such are accepted by certification as opposed to the in-place testing used with QC/QA HMA. These mixes are used for assorted purposes, such as rumble strips, wedge and level, temporary pavement, curbing mixtures, patching mixtures, and other instances where the concepts of QC/QA acceptance are impractical. Requirements for these mixtures are found in Section **402**.

### ***Quality Control***

The Quality Control Plan requirements for non-QC/QA HMA mixtures are identical to those for QC/QA HMA mixtures as covered in the previous section of this chapter. Unlike QC/QA, however, HMA QCP methodology is more process driven at the time of placement, as samples are not generally taken for testing.

### ***Pay Item Description***

402 HMA pay items have a "402 Mix Type" component which has an equivalent design ESAL category. ESAL stands for *Equivalent Single Axle Load*, and is the effect on pavement of any combination of truck axle loads of varying magnitude equated to the number of 80-kN (or 18,000-lb) single-axle loads that are required to produce an equivalent effect.

For example, the *Type B* designation in the pay item **HMA Surface, Type B** designates an ESAL category of less than 3,000,000. The ESAL categories range from *Type B* for the lowest anticipated truck traffic volumes to *Type D* for the pavements with the highest expected truck volumes. Unlike QC/QA HMA, these pay items do not include any reference to the PG binder required or a specific nominal aggregate size. Section **402.04** includes a minimum PG binder grade for each ESAL category and allows the Contractor to select the nominal aggregate size for each mixture.

### ***Acceptance of Mixtures***

The primary difference between HMA and QC/QA HMA mixtures is the method of acceptance as specified in Section **402.09**. HMA mixes are accepted by a Type D Certification in accordance with Section **916**. As these mixtures are accepted by certification, no QA sampling or testing is required. However, the Producer is still required to conduct QC Testing in accordance with the Quality Control Plan for the HMA Producer Program/Plant, **ITM 583**, and the Quality Control Plan for the Contractor, **ITM 803**.

---

## **QC/QA STONE MATRIX ASPHALT PAVEMENT**

QC/QA Stone Matrix Asphalt pavement, *QC/QA SMA* or simply *SMA*, is a durable, stable, rut-resistant mixture that relies on coarse aggregate contact within the mixture to provide strength and a rich mortar binder to provide durability as specified in Section **410**. Since aggregates do not deform as much as asphalt binder under load, this aggregate-to-aggregate contact greatly reduces rutting. The bonding substance consists of asphalt binder, mineral filler (material passing the No. 200 sieve), and a stabilizing additive of either cellulose or mineral fibers.

The primary advantage of QC/QA SMA is extended life as compared to conventional dense-graded mixtures. This extended life is expected as a result of better rut resistance and the potential to reduce reflection cracking. Other potential advantages are the reductions in traffic noise as well as tire splash and spray. A possible disadvantage to look out for, however, is surface bleeding and draindown of fine aggregate due to higher asphalt content.

QC/QA SMA is more expensive than a typical dense-graded HMA because it requires more durable aggregate alongside higher asphalt content and additive(s). With cost-efficiency in mind, QC/QA SMA should be used in circumstances where increased rut resistance, improved durability, and longer life is exceedingly desirable and worth the increase in cost.

---

## CHAPTER THREE: *PAVING EQUIPMENT*

---

Before paving operations may be started, all of the paving equipment is required to be checked for conformance with the Section **409** and the Contractor's Quality Control Plan. If the equipment functions properly, the chances of a successful paving operation are greatly increased.

The major pieces of paving equipment on a HMA contract are distributors, pavers, material transfer devices, widening machines, rollers, and hauling trucks. Each piece of equipment is required to be checked prior to beginning the paving operation to ensure that the equipment is in good working order and in compliance with specific requirements.

---

### DISTRIBUTORS

A distributor is used to apply liquid asphalt material such as prime and tack coats to surfaces to be paved as shown in Figure 3-1. The distributor consists of an insulated tank mounted on a truck or trailer. A power-driven pump forces the asphalt through a system of spray bars and nozzles onto the construction surface. An oil-fired burner, generally, with flues through the tank, heats the asphalt to the proper application temperature.



*Figure 3-1 Distributor Truck*

The distributor is required to:

1. Maintain the liquid asphalt at a uniform temperature
2. Apply material at a uniform rate
3. Apply material at variable widths

The distributor is required to be equipped with:

1. A tachometer (Bitumeter) to measure the speed during applications
2. Pressure gauges
3. Accurate volume measuring gauges or a calibrated tank
4. A thermometer for measuring temperatures
5. A power unit for the pump
6. Full circulating spray bars to prevent material cooling in the spray bars. The spray bars are required to be adjustable both laterally and vertically

---

### PAVERS

HMA and SMA mixtures are placed by a paver (Figure 3-2). The HMA paver spreads the mixture in either a uniform layer of a desired thickness or a variable layer to a desired elevation and cross section. Upon placement, the HMA is ready for compaction.

## PAVER COMPONENTS

The paver consists essentially of a tractor and a screed. The tractor receives, conveys, and augers the mixture to the screed and propels the screed forward. The tractor may be mounted on either rubber tires or crawlers. In addition to the engine, the tractor unit has a hopper for receiving mix from a haul truck or a material transfer machine, conveyors to move the mix through the flow control gates to the augers, flow gates to regulate the flow of mixture to maintain uniform auger speed, and augers to evenly spread the mix in front of the screed. If haul trucks are used, rollers are mounted on the front of the tractor to push the haul trucks during the dumping process. The rollers turn freely so the trucks have little effect on paver operation. The screed conducts the actual placing to the desired width and thickness or elevation as indicated in Figure 3-3. The screed is towed by the tractor and is free to float up or down until the bottom of the screed is parallel with the grade over which the screed is traveling.



Figure 3-2 HMA Paver

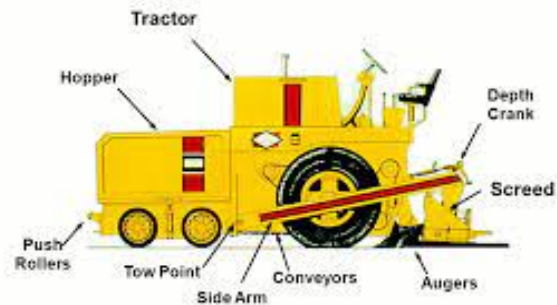

Figure 3-3 Paver Components

## TOWED SCREED

The relationship between the vertical movement of the screed tow point and the elevation of the screed is illustrated in Figure 3-4. There is an 8 to 1 ratio between the tow point and the elevation; therefore, a 1" vertical movement of the tow point results in only a  $\frac{1}{8}$ " vertical corrective movement of the screed. Before the  $\frac{1}{8}$ " movement is made, the paver moves five times the length of the screed side arm. This relationship is the key to the paver's ability to lay smooth pavements.

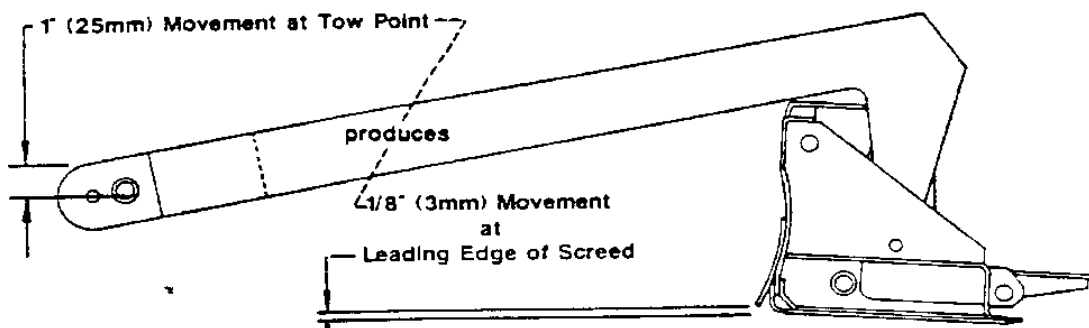

Figure 3-4 Screed Tow Point and Elevation



## **PAVER REQUIREMENTS**

The paver must:

1. Be a self-contained power propelled unit, equipped with a material receiving system
2. Be equipped with an activated (vibratory) screed or strike-off assembly capable of being heated for the full length, including extensions. Auger extensions are required with the extendable screed
3. Be capable of spreading and finishing mix in lane widths indicated on the typical sections for the contract
4. Be equipped with automatic grade and slope controls if the width of the roadway or shoulder to be paved is 8 ft or more in width. The operator's control panel is required to have gauges that indicate compliance with the established grade and slope
5. Have a grade leveling system (commonly called a ski or mat reference) for attachment to the paver to activate the automatic grade control
6. When a dense graded intermediate or a surface mixture is placed adjacent to an aggregate or earth shoulder, be equipped with a device capable of constructing a safety edge on the side of the paver adjacent to the said shoulder

## **PAVER SCREED CONTROLS**

The automatic screed controls may be set for manual, semiautomatic, or automatic operation on most pavers. Paver screed control components are illustrated in Figure 3-5.

Automatic screed controls typically have the following main components:

1. Infrared sonic grade sensor
2. Non-contact slope sensor
3. Control station
4. Slope control
5. Motors and hydraulic cylinders to change the screed tilt

The grade sensor rides on a string-line, a ski, or a joint matcher to detect changes in elevation and transmit the information electronically to the controls. The electronic controls may be checked by varying the position of the grade sensor and observing if the screed controls react to make the correct adjustment. When the ski is used, the grade sensor is required to always ride on the center of the ski so that all elevation changes are averaged.

Use of the automatic controls further enhances the paver's capability to produce a smooth pavement surface regardless of irregularities in the surface being paved. Crown or superelevation slope is controlled by the slope sensor or pendulum set for the desired slope. Once the screed is set for the desired course thickness and slope, the automatic controls activate the motors or cylinders to change the screed tilt to automatically compensate for road surface irregularities. Automatic slope and grade controls are required to be used as outlined in the Quality Control Plan (QCP).

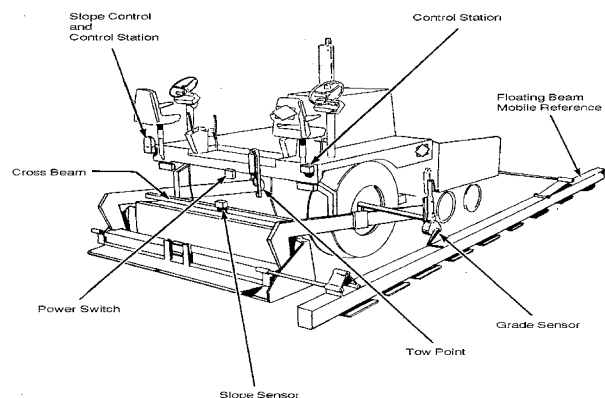

Figure 3-5 Paver Screed Controls

## **SPRAY PAVER**

The use of spray pavers as seen in Figure 3-6 may be an option to consider for paving operations. Spray pavers combine the processes of both the paver and distributor truck into one machine, which makes this feature a primary advantage to conventional pavers. Spray pavers allow the application of an emulsion tack coat and the placement of an asphalt paving course in one process. The paver utilizes rows of emulsion distribution nozzles placed in front of the hopper and near the rear axle.



*Figure 3-6 Spray Paver*

The distribution nozzles can coordinate spray patterns to place a uniform coat of emulsion on the existing surface. The distribution nozzles provide a consistent and uniform application just prior to the placement of the asphalt pavement course. This process helps eliminate the potential for the traveling public or the paver to track emulsion on tires or treads. These pavers can also perform paving operations without utilizing their emulsion application process.

---

## **WIDENING MACHINES**



*Figure 3-7 Widening Machine*

Widening machines, like those shown in Figure 3-7, are used when the pavement width is too narrow for a regular paver or is inaccessible. An inside 4 ft shoulder of a dual-lane highway is one instance where HMA may be placed separately using a widening machine.

Widening machines are required to be self-propelled and capable of placing material at variable widths. Vibrating or heated screeds and automatic grade and slope controls are not required for these machines, though automatic grade controls for matching joints are available on some models. Self-propelled wideners are usually used for widths up to 4 ft, and wideners mounted on motor- graders are used for widths between 4 ft and 8 ft. The use of widening pavers is not allowed on widths of 8 ft or more.

---

## **COMPACTION EQUIPMENT**

Six types of rollers are used for compacting HMA: two-axle tandem, three-wheeled, pneumatic tire, vibratory, oscillatory, and trench. All have steel wheels except for tire rollers.

Rollers must have proper sprinkling systems to wet the drums or tires to prevent the mix from sticking, while scrapers are also required on steel-wheel rollers. Rollers are required to be equipped with drip pans to prevent oil, grease, or fuel from dropping onto the roadway, as petroleum products damage HMA pavement. Clutches must function smoothly – a roller that jerks when starting, stopping, or reversing can roughen the surface.

QC/QA mixtures in accordance with Section **401** are compacted with rollers designated in the Contractor's Quality Control Plan. HMA mixtures are required to be compacted by the rollers designated in Section **409.03(d)**, and SMA mixtures are compacted with rollers in accordance with Section **409.03(d)1**, **409.03(d)2**, or **409.03(d)7**.

**TWO-AXLE TANDEM ROLLER**

A two-axle tandem steel-wheel roller (Figure 3-8) is required by Section **409.03(d)1** to weigh at least 10 tons. This type of roller should be operated at a maximum speed of 3 mph.



Figure 3-8 Two-Axle Tandem Roller

**THREE-WHEEL ROLLER**

The three-wheel roller (Figure 3-9) is required by Section **409.03(d)2** to have three wheels with a minimum bearing of 300 lb/in on the rear wheels. This bearing weight is computed by dividing the weight of the drive axle by the combined width of the two rolls. A tandem roller with a drive wheel bearing of no less than 300 lb/in may be used in lieu of the three-wheel roller. This roller should be operated at a maximum speed of 3 mph.



Figure 3-9 Three-Wheel Roller

**PNEUMATIC TIRE ROLLER**

A pneumatic tire roller (Figure 3-10), per SS **409.03(d)3**, must be a minimum 5' 6" wide, be equipped with wide-tread compaction tires of a minimum size of 7:50 by 15, be capable of exerting a uniform, average contact pressure from 50 to 90 lb/in<sup>2</sup> over the surface by adjusting ballast and tire pressure, have fully vertically oscillating wheels on at least one axle mounted as to prevent scuffing of the pavements during rolling or turning, and operate at a maximum speed of 3 mph.



Figure 3-10 Pneumatic-Tire Roller

The Contractor is required to furnish charts and tabulations indicating the contact areas and pressures for the full range of tire inflation pressures and for the full range of tire loadings for each type and size of pneumatic-tired roller to be used.

The tires on a pneumatic tire roller are typically arranged so the gaps between the tires on one axle are covered by the tires of the other as shown in Figure 3-11.

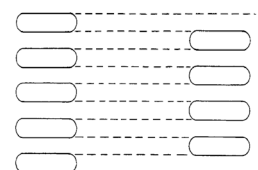

Figure 3-11 Pneumatic Tire Roller Tire Pattern

### **VIBRATORY ROLLER**

Vibratory rollers (Figure 3-12) are required by Section **409.03(d)4** to be outfitted with two drums equipped for vertical impact forces, a variable amplitude system, a speed control device, and have a minimum vibration frequency of 2,000 vibrations per minute. A reed tachometer shall be provided for verifying the frequency of vibrations



Figure 3-12 Vibratory Roller

### **OSCILLATORY ROLLER**

An oscillatory roller (Figure 3-13), found in Section **409.03(d)5** has dual, opposed, eccentric weights that rotate in the same direction around the drum axis. The rotation of the weights causes the drum to move in a rocking motion instead of a vertical motion that is provided by vibratory rollers. This rocking motion creates horizontal and downward shear forces. Because the drum does not bounce like a vibratory roller, the oscillatory roller provides a smoother surface of the mixture. Typically, oscillatory rollers are used in special applications. They can help achieve density but reduce the impact on nearby pipes or buildings.

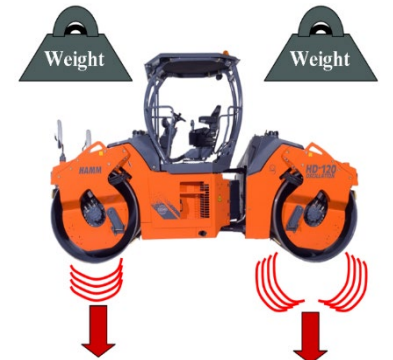

Figure 3-13 Oscillatory Roller

### **TRENCH ROLLER**

When the width of a trench is too narrow to accommodate a standard roller, a trench roller (Figure 3-14) is used for compaction. The trench roller is required by Section **409.03(d)6** to be of sufficient weight to exert a pressure of 300 pounds per linear inch of width for the compression wheel. The compression wheel may be either hollow or solid. Weight is added to hollow wheels by filling the wheel with water ballast. Counterweights are used for rollers with solid wheels.



Figure 3-14 Trench Roller

To provide uniform compaction for the entire width of the compression wheel, the face of the wheel is required to be parallel to the surface being compacted. Trench rollers use a vertical adjustment on the wheel not in the trench to tilt the machine to accomplish this uniform compaction.

---

## **MATERIAL TRANSFER VEHICLES**

Material Transfer Vehicles (Figure 3-15), known as MTVs or Shuttle Buggies, are used to transfer mix from the haul trucks to the paver and is generally the preferred method to place mix. Once material is dumped into the MTV, the equipment remixes the load uniformly, with current and previous loads, and conveys it to the paver.



Figure 3-15 Material Transfer Vehicle

Physical and temperature segregation has been shown to be significantly reduced due to the remixing of the material prior to the material being fed into the paver. The use of this equipment has also shown to improve pavement smoothness because the MTV does not come into physical contact with the paver. Instead, the MTV fills the paver's hopper by dropping material from above.

---

## HAUL TRUCKS

Haul trucks (Figure 3-16) are used to transport mix to the MTV or paver. The following check points should be monitored when a truck arrives on site:

1. Watch for foreign or old, clumped material in the mix which would indicate that the beds were not clean before loading
2. Ensure trucks are equipped with tarps and are used as needed to keep the material from cooling or becoming contaminated en route
3. Ensure these watertight tarps overlap the bed of the trucks enough to prevent rain and foreign material from getting into the mix
4. Inspect for evidence of excess use of approved anti-adhesive agents
5. Watch for hydraulic or fuel leaks



*Figure 3-16 Haul Trucks*

---

## HAND TOOLS

Standard hand tools used in the paving operation include shovels, lutes, and straightedges. Straightedges come in ten-foot and sixteen-foot varieties, both of which have adjustable bolts to mark tolerance points at  $\frac{1}{4}$ ,  $\frac{1}{2}$ , and  $\frac{3}{4}$  of the straightedge length, and are mounted on wheels.

Fuel oil, kerosene, and solvents shall not be transported in open containers on equipment. Cleaning of equipment and small tools shall not be performed on the pavement or shoulder areas to avoid contaminating the work area.



---

# CHAPTER FOUR: *PREPARATION OF SURFACE*

---

HMA pavements may be placed on the following surfaces:

1. Over existing HMA or concrete pavement
2. On newly constructed subgrade, aggregate base or HMA base courses
3. A combination of existing pavement and base course if, for example, widening a lane

The existing surface is required to be compacted, stable and free from mud or other foreign matter before placing the new HMA pavement. Preparation for a HMA course may include subgrade treatment, proofrolling, milling, patching, leveling, wedging, and cleaning. The surface is required to be inspected for cross slope, potholes, base failure, dips, and bumps to determine the need for corrections.

The requirements of the Contractor for surface preparation are designated in the Quality Control Plan (QCP) for the contract. For more information on QCPs, refer to *Chapter Two: Mix Composition Types*.

---

## SUBGRADE TREATMENT

Subgrade on which a HMA course may be placed is specified in Section **207**. One of several Subgrade Treatment Types may be allowed and is specified in the Contract Plans and Section **207.04**. One subgrade treatment procedure is chemically modifying the soil (Figure 4-1).



Figure 4-1 Chemically Modifying Soil

---

## PROOFROLLING

In some cases the subgrade or subgrade treatment areas may be accepted by proofrolling in accordance with Section **203.26**. The action of proofrolling consists of a loaded dump truck driving slowly over the subgrade of the entire paving area with the technician witnessing the deflection or rutting of the surface. The primary purpose of proofrolling is to visually locate soft subgrade areas, check the subgrade compaction, and to provide uniform support to receive HMA base for the pavement structure. Soft subgrade areas that are located shall be remedied per specification.

---

## MILLING

Milling is part of a pavement rehabilitation process where a portion of the existing HMA or PCC pavement surface area is removed. The milling machine (Figure 4-2) can grind at variable depths and pitch across the full lane width.



Figure 4-2 Milling Machine

Milling is done prior to repaving for many reasons including:

1. Removal of distressed pavement
2. Improve smoothness
3. Reshape cross slopes
4. Eliminate shoulder work after new layer(s) are placed (mill and fill)
5. Maintain curb exposure
6. Maintain clearances and other drainage features
7. Transitions to approaches or other pavement where new paving stops
8. Roughing the existing surface texture to remove asphalt joint material

There are several different pay items for milling depending on the application, but all are paid by the square yard as specified in Section **306**. The specific type of milling is specified in the contract. Possible milling types include:

1. Approach Milling
2. Asphalt Milling
3. Asphalt Removal
4. PCCP Milling
5. Scarification/Profile Milling
6. Transition Milling

The macrotexture after milling is required to be checked in accordance with **ITM 812** and Section **306.04**. Milling procedures and procedures to check macrotexture and cross slopes are required to be described in the QCP.

Milling operations should be included in the quality control plan in accordance with **ITM 803**. Where the milling operation in a partial-day closure results in a longitudinal vertical or near vertical face exceeding 2" in height, the adjacent lane shall be milled during the same day, the milled lane resurfaced during the same day, or the vertical face tapered at a 45° angle or flatter. Where located within 3" of a curb, surface material that cannot be removed by the milling machine shall be removed by other approved methods.

Transverse milled vertical faces greater than 1" that are exposed to traffic shall be transitioned in an approved manner.

Castings located in milling areas that are not to be adjusted may remain in place during the milling or may be removed and replaced at the Contractor's option.

The millings produced become the property of the Contractor and may be transported to a HMA plant facility for use as recycled asphalt pavement (RAP). When specified, millings may be used to construct shoulders.

---

## PATCHING

Unsuitable areas are required to be identified and marked for removal by Department personnel. Areas to be removed include potholes, base failures, unstable mixes in place, and spots with excess asphalt. If the pavement to be patched is overlaid, the edge of the removal area is not required to be sawed. The removal area is required to conform to the marked lines to minimize over-breakage. If the patch is not overlaid, a neat edge for the patch is required to be attained by sawing. The size of the patches depends on the conditions found on the



contract. The size and depth of the excavation are required to be measured and recorded for determination of the pay quantities. A typical full depth HMA patch section is illustrated in Figure 4-3.

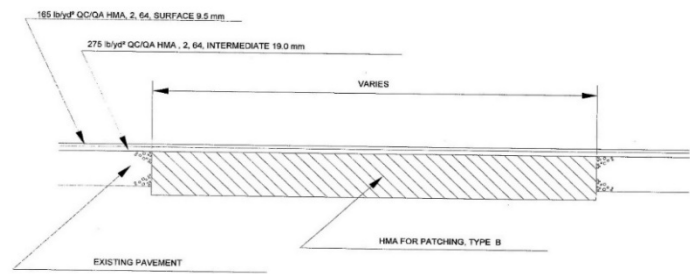

Figure 4-3 Typical Full Depth HMA Patch Section

Where unstable material is encountered below the existing pavement in the base, subbase, or subgrade, this material is removed. The sides of the excavation are required to be vertical because HMA does not properly compact against sloping sides. The bottom of the removal area is compacted and the area backfilled with suitable material up to the bottom of the existing pavement.

Before placing the HMA patching material, the edges of the existing course are cleaned and tacked with asphalt to ensure a bond between the old surface and the new mix. The finished thickness of any course shall be at least two times but not more than four times the maximum particle size as shown on the DMF, except 4.75 mm mixtures shall be at least 1.5 times but not more than 3 times the maximum particle size shown on the DMF. Each lift is required to be compacted and sufficiently cooled before placing the next lift.

Patching operations are scheduled so that all removal areas opened during the day are completely patched at the close of the work day to allow opening the lane to traffic. When a patch cannot be completed, it shall be backfilled, compacted, and a temporary surface placed to carry traffic during the night. All temporary work is at the expense of the Contractor and is avoided if at all possible.

## WEDGE AND LEVEL

When the surface of a pavement is irregular, the surface is required to be brought to a uniform grade and cross section. Normally, milling is specified to correct this problem; however, sometimes a leveling course is used. Wedge and level may not be the best practice since proper compaction is difficult when non-uniform thicknesses are placed. The HMA materials used are specified in the contract and Section **402.07(b)**. Wedges of HMA are used to level sags and depressions in an old pavement prior to the paving operation.

Leveling and wedging material is required to be placed in lifts to ensure compaction. The top of each lift is required to be parallel to the desired profile or cross section. Because of the difficulty of feathering the edges of HMA mixtures, placing the material in lifts parallel to the existing surface usually results in rough patches that reflect to the finished surface. Each of these examples are shown in Figure 4-4.

The number and lengths of lifts are determined by the allowable lift thickness and the depth of the area to be leveled.



Figure 4-4 Correct and Incorrect Wedge and Level

Wedges are also used to re-establish the crown on a tangent roadway or superelevation on a curve (Figure 4-5). The number of wedge courses necessary to rebuild the crown or superelevation depends on the total depth to be placed and the maximum particle size in the mix.



Figure 4-5 Crown Wedge

The finished thickness of any course shall be at least two times but not more than four times the maximum particle size as shown on the DMF, except 4.75 mm mixtures shall be at least 1.5 times but not more than 3 times the maximum particle size shown on the DMF. Feathering may be less than the minimum thickness requirements.

Acceptance of patching material and wedge and level is done on the basis of a Type D certification. This certification is needed before the material may be incorporated into the project. The Type D certification is required to report the air voids and binder contents of the mix. The allowable deviations from the DMF are 1.5 % for air voids and 0.7 % for the binder content. If the results do not comply with these requirements, the HMA is processed as a failed material.

---

## SURFACE CLEANING



Figure 4-6 Power Broom

Existing surfaces are required to be cleaned before applying a tack coat. Cleaning may be done by sweeping, but sometimes mud or other foreign matter must be removed with shovels and hand brooms. Where dirt is embedded, a pressure washer or compressed air may aid in thorough cleaning. Power brooms are typically used for sweeping (Figure 4-6).

Excess asphalt material at cracks and joints is required to be removed to the elevation of the existing surface or below. Failure to remove the excess asphalt materials results in "bleeding" of the asphalt through the subsequent courses causing bumps or other irregularities in the surface.

---

## TACK COAT

A tack coat is the application of asphalt material, also referred to as emulsion, to an existing paved or milled surface (Figure 4-7). The primary purpose of the tack coat is to adhere the newly placed HMA to the paving surface. Tack coats are covered by Section 406. The material that is used for tacking is Asphalt Emulsion, SS-1h or AE-NT (Section 902.01(b)).

### APPLICATION

The tack coat is applied with an asphalt distributor and is required to be uniformly applied with a pressure distributor. More technical information in regards to the asphalt distributor can be found in [Chapter One: Paving Equipment](#).



Figure 4-7 Tack Coat Application

The asphalt material application rate are based on the existing surface type, as follows:

Surface Type	Application Rate*(gal./sq yd)
New Asphalt	0.05 to 0.08
Existing Asphalt	0.06 to 0.11
Milled Asphalt	0.06 to 0.12
PCCP	0.05 to 0.08

\* The asphalt material shall not be diluted.

*Table 4-1 Asphalt application rates*

Typically, the entire tacked area should be covered by mix each day. The rate of application, temperature, and areas to be treated are required to be approved by the PEMS before the application. In the event of rain or other circumstances where the tack coat remains uncovered, the material may be lightly sanded and provisions made for traffic safety.

The following are some key tack coat inspection points:

1. The application surface is clean of debris and any standing water
2. Uniform and adequate coverage without streaking or puddling
3. Minimal truck tracking of the tack coat, this can be mitigated by allowing sufficient time for the tack coat to break and set before equipment tracks the material

When the Contractor cannot get uniform coverage and streaking or puddling continues despite adjustments to the distributor, the use of a burlap drag may be required. The tack coat may be mopped, broomed, or squeegeed to obtain a more even distribution or to facilitate curing.

Figure 4-8 is an example where streaking has occurred. This is commonly caused by clogged nozzles on the distributor spray bar. In situations where one or more of the spray bar nozzles are clogged, there will be portions of the existing pavement that are either lightly coated or not coated at all. If a distributor spray bar nozzle becomes clogged, the distributor should be stopped and the clogged nozzle or nozzles repaired or replaced prior to resumption of application of the asphalt material.



*Figure 4-8 Poor Tack Coat Application*

Areas inaccessible to the distributor's spray bar are tack coated with hand sprayers. Extreme care is required to be taken with the hand spray to obtain uniform coverage without puddling.

Depending on the contract, tack coat is measured and paid for by either the ton or the square yard. If tack coat is being paid for by area, determine the area covered by tack on a daily basis. If tack coat is paid for by weight, collect the weigh tickets from the distributor driver each day. Run a daily total of weigh tickets to determine the daily quantity.

**BREAKING AND SETTING**

Time is required to allow the asphalt material to break and set before the HMA is placed on the tack coat. The emulsion turns from brown to black and becomes sticky when the material "breaks" and the water evaporates. When the emulsion has set, it has fully cured and can be opened to construction traffic.

---

## PRIME COAT

A prime coat is the application of asphalt material used on rubblized concrete pavements and acts as an initial sealer in the asphalt placement process to block the other layers from moisture, dust, and debris before additional HMA courses are placed.

The prime coat also binds together any dust on the surface and promotes the bond between the pavement and the HMA overlay. Section **405** includes the requirements for the allowable materials, equipment, preparation of surface, and application rate of asphalt materials and cover aggregate for prime coats. The asphalt material is not allowed to be applied on a wet surface, when the ambient temperature is below 50° F, or when other unsuitable conditions exist, unless approved by the Engineer. The rubblized concrete pavement to be treated is required to be shaped to the required grade and section, free from all ruts, corrugations, or other irregularities, and uniformly compacted and approved.

---

---

# CHAPTER FIVE: *MIX PLACEMENT AND COMPACTION*

---

---

The procedures for mix placement and compaction, are in general, specified by the Contractor in the Quality Control Plan for QC/QA HMA (Section **401**), HMA (Section **402**) and SMA (Section **410**) mixtures for the contract.

The paving and compaction equipment on a HMA contract are distributors, pavers, material transfer devices, widening machines, rollers, and haul trucks. Before paving operations may be started, all of the paving equipment is required to be checked for conformance with the Specifications and the Contractor's QCP. A pre-paving meeting is a good practice to assure that all of the personnel involved in the paving and compaction operation understand the procedures to be used on the project. Pre-paving meetings should be held prior to beginning paving operations for the project, prior to phase changes in a project, and at the beginning of each construction season for multi-year projects.

---

## WEATHER LIMITATIONS

Hot mix asphalt may be placed only when weather conditions are favorable. Placing the mix on a cold surface or when the air temperature is low causes the mix to cool too quickly. No mixture of any type may be placed on a frozen subgrade.

QC/QA HMA courses of less than 138 lb/yd<sup>2</sup> and SMA mixtures are required to be placed when the ambient temperature and the surface temperature is 45° F or higher. Minimum temperatures for non-QC/QA HMA are shown in Table 5-1. HMA courses may be placed at lower temperatures provided the density of the HMA course is controlled by plate and core samples as indicated in Section **402.16**.

Non-QC/QA HMA Courses	Air Temp	Surface Temp
≥ 220 lb/yd <sup>2</sup>	32° F	32° F
≥ 110 lb/yd <sup>2</sup> and < 220 lb/yd <sup>2</sup>	45° F	45° F
< 110 lb/yd <sup>2</sup>	60° F	60° F

*Table 5-1 Minimum Temperatures for 402 HMA*

Paving mixtures may not be laid on wet surfaces or when other conditions are obviously not suitable, even if air and surface temperatures are within the limits.

Mixing at the plant is required to stop when rain starts; however, material, which is on the way to the contract, may be placed if the rainfall is light enough to avoid excessive cooling, segregation or raveling after compaction. Since rain may be prevalent at the paving site but not at the plant, a means of rapid communication is required to be provided to prevent several loads of material from being delivered which may not be used.

---

## TEMPERATURE AND APPEARANCE AT POINT OF DELIVERY

The quality and temperature of the mix at the paving site should be continually monitored. This is done by visually observing each load and by periodically checking the temperature of the mix before being unloaded.

When a truck arrives on-site, check the following items prior to accepting a load:

1. Verify the maximum aggregate size of the mix being placed. The mix designated on the ticket must match the course being placed, and the Mix Design must be accepted
2. The coloring of the mix should be consistent throughout the load. Improper mixing at the plant may result in some parts of the mix being lighter in color than others
3. All aggregate is required to be coated with asphalt. Ensure large coarse aggregate with rough surface texture is entirely coated
4. Asphalt puddling on the surface indicates insufficient mixing
5. Blue smoke rising from the mix indicates the temperature of the mix is too hot. Check the temperature of the mix to confirm, as a smoky truck load may also indicate the use of fuel oil as an anti-adhesive in the truck bed
6. Segregation is the most common mix problem; aggregate particles must be distributed throughout the mix. If coarse aggregate dispenses at the very beginning or very end of the load, the mix is segregated due to improper mixing or settling
7. Specifications require the maximum temperature at the time of spreading to be no more than 315° F when PG 58-28, PG 64-22, PG 64-28, or PG 70-22 binders are used and not more than 325° F when PG 70-28 or PG 76-22 binders are used. Mix temperatures at the paver site should never be higher than these limits

To attain the best results, HMA mixes are required to be placed at the optimum temperature. For mixtures not controlled by density cores, Section **401.13** requires mixture at the time of spreading to be no less than 245° F. Normally a surface thermometer is sufficient for obtaining an accurate temperature of the mixture, but in cases where a load may need to be rejected, a probe thermometer can be requested from the paver crew. Also, a previously placed mix course should be no more than 175° F before a new course is placed on top.

---

## PAVING OPERATION

Many types of pavers are used for HMA paving operations. As such, the below information may not apply to all pavers, but should be representative of the general operations of a paver.

### **SCREED CONTROL**

The primary factor in producing a high-quality pavement is controlling the vertical position of the free-floating screed with respect to the grade surface over which the paver is moving. Several factors influence the vertical position of the screed, such as the paving speed, head of material, mix consistency, pre-compaction, and angle of attack. If any of these factors is off during a paving operation, the variation can change the course depth, density, or texture.

The three primary variable factors which influence the vertical position of the free-floating screed (Figure 5-1) are Angle of Attack (**F1**), Head of Material (**F2**) and Paving Speed (**F3**)

## Angle of Attack

The *angle of attack* is the angle that exists between the bottom surface of the screed and the surface over which the paver is moving. Paving over a flat, level surface with consistent variables produces a consistent course. A vertical displacement of the screed or tow point changes the angle of attack. The screed must move to restore the original angle, as illustrated in Figure 5-2. This is referred to as self-leveling.

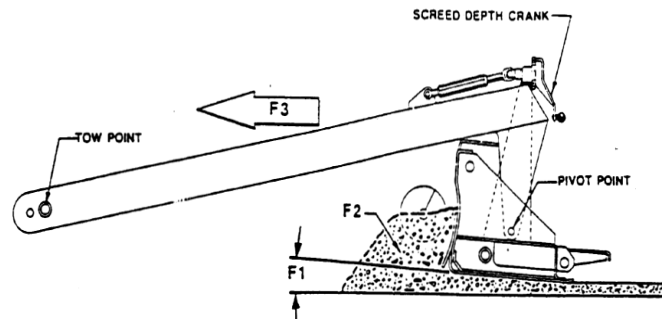

Figure 5-1 Free Floating Screed

When the angle of attack is increased, more material can pass under the screed, causing the screed to rise until it once again is moving on a plane parallel to the grade surface.

Decreasing the angle reduces the amount of material allowed to pass beneath the screed, causing the screed to drop until the screed is again parallel to the grade.

The angle of attack is controlled by either manual screed depth cranks or automatic level controls. One full turn of the depth crank raises or lowers the screed approximately  $\frac{1}{4}$ ".

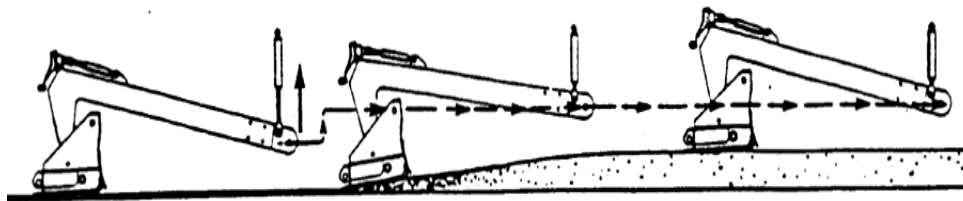

Figure 5-2 Angle of Attack is corrected by self-leveling

## Head of Material

The *head of material* is the volume of material directly in front of and along the length of the screed. The volume and consistency of the head of material are primary factors in the amount of mix that flows under the screed, affecting the course density, texture, and profile. The head of material determines the resistance to forward travel exerted on the screed.

Figure 5-3 shows various levels of material along the screed. The head of material should be maintained at a near constant level along the length of the screed, from the center to almost covering the auger shaft. Modern pavers use automatic leveling.

When the head of material is too high, resistance to forward travel is increased causing the screed to rise, which results in ripples, auger shadows, long waves, increased depth, or a less dense mat. When the head is too low, resistance to forward travel is decreased and the screed gradually falls, resulting in a thin mat with possible voids.

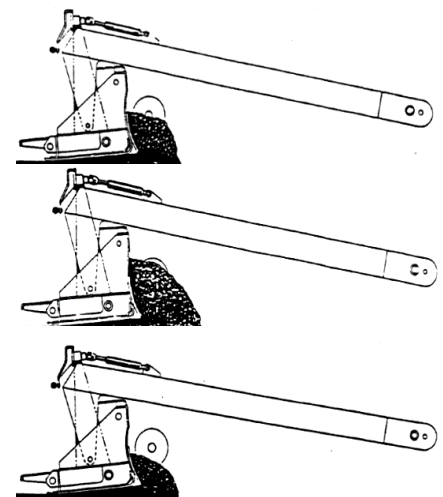

Figure 5-3 Head of Material on Screed:

A fluctuating head of material results in a combination of the mat deficiencies described above, plus alternating changes in the mat texture and depth.

### ***Paving Speed***

The speed of the paving operation is determined by the rate of material delivery to the paver. The optimum speed results in the paver being in continuous operation, using the mixture as the material is delivered, and never having trucks stack up waiting to unload. Continuous, uninterrupted forward travel at a constant speed, with other variables held constant, produces a smooth riding surface. While absolute compliance with this goal is usually not possible, fewer interruptions or changes in paving speed provide a smoother finished surface. The paving speed is required to be adjusted to give a uniform texture and coordinate with plant production.

Paving speed to match plant production may be computed for any planned quantity. The paving speed and plant production must match and should be outlined in the QCP.

Pavers may not operate at speeds in excess of 50 ft per minute for mixes that are not density controlled by cores. Excessive paver speeds often result in non-uniform surfaces.

Whenever the absence of loaded trucks necessitates a pause, the paver is stopped with a substantial quantity of mix ahead of the screed. Operating the paver until the mix is too low ahead of the screed results in a dip in the pavement.

In addition to the three major factors discussed, other improper operating procedures which may affect the riding quality of the pavement include:

1. A truck bumping into the paver
  - This practice is the most common cause of transverse marks and ridges in the finished mat. Drivers are required to stop their trucks ahead of the paver and let the paver operator pick up the truck as the paver travels forward
2. A truck driver holding the brakes
  - This practice reduces the paving speed causing an increase in course depth and may cause the paver wheels to slip or break traction. This problem causes a non-uniform edge line of the course and a bump in the mat
3. Paver engine in poor operating condition
  - An improperly functioning engine may cause power and speed surges resulting in ripples, waves, or auger shadows in the mat
4. Unequal or over inflation of paver tires
  - This may cause the drive wheel to slip or break traction resulting in a rough, uneven mat
5. Loose or unevenly tensioned traction drive chains
  - This may cause power or speed surges resulting in ripples, waves, or auger shadows in the mat

Automatic grade and slope controls are required to be outlined in the QCP for mixtures produced in accordance with Section **401**. Section **402** indicates that automatic slope and grade controls are required except when placing mixtures on roadway approaches which are less than 200 ft in length or on miscellaneous work.



## **START-UPS**

Three types of start-ups are used in hot mix asphalt paving:

1. Full depth
2. Continuing an existing lay
3. Feathering

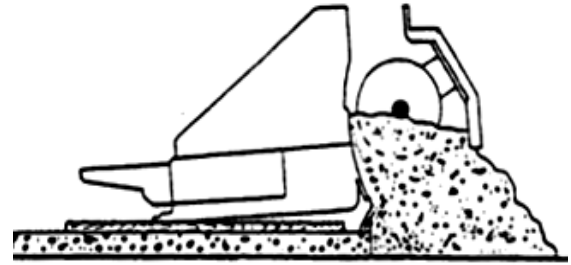

*Figure 5-4 Continuing on Existing Lay*

A full depth start-up is used when starting a new pavement mat. To begin, the screed is elevated from the grade by the thickness of the course plus a margin to allow for compaction by rolling. Blocks of the required thickness may be placed under each end of the screed.

When resuming a previously laid mat, the tapered material is removed back to the full-depth section and the joint is tacked. Strips of lath sized to allow for the compaction margin are placed under the ends of the screed. The front of the screed should never be placed beyond the joint.

When building a start-up feather joint, the screed is set directly on the existing pavement at an angle to gradually taper up to the full depth. The feathering is required to be long enough to provide a smooth transition from old to new surfaces. Temporary transverse joints, if constructed under traffic, are also feathered.

Paving exceptions are indicated on the plans. Bridges, except for earth-filled arches, are exception from paving, as adding HMA pavement over a concrete bridge deck would reduce its lifespan, causing deterioration to the deck. There may also be exceptions when paving under a bridge if the result might reduce the overhead clearance to an unacceptable height.

With any start-up, the screed and any bolted-on screed extensions are required to be pre-heated before any mix is processed through the paver. Screed heaters are provided on all pavers for this purpose, but the main screed's heating device may not provide heat to the extensions. After preheating, the heaters are turned off as heat is maintained by the HMA.

## **TRANSVERSE JOINTS**

A transverse joint, commonly called a day joint, is normally required at the end of each day's paving to provide a smooth transition for traffic. The procedure for the construction of the transverse joint is required to be included in the QCP for the project.

The last few feet of the course is left unrolled, the mix is cleared away from the wedge area, joint paper is laid on the existing surface and up the vertical face of the joint, the mix is shoveled over the paper to form the wedge, and the course is rolled. The Contractor is not allowed to completely empty the paver hopper to make the day joint since some of the mix still in the hopper is too cold.

When paving is resumed, the wedge and paper are removed to provide an exposed course that is full-depth and at the proper grade for continuing the lay. The screed is elevated with blocks as previously described. The paver is positioned with the front of the pre-heated screed over the joint line. After the hot mixture is conveyed into place, sufficient time to re-heat the joint is allowed before moving the paver forward. The paver is advanced enough to allow the workmen to conduct the necessary handwork. The straightedge is required to be used to check

the joint to ensure the proper grade before allowing the roller on the surface. Once the joint has been rolled, the joint is rechecked with the straightedge. If any corrections are required, there should be sufficient heat remaining in the mix to make the joint smooth.

### **LONGITUDINAL JOINTS**

Longitudinal joints are made when joining adjacent lays to make the specified width of pavement. Longitudinal joints in the surface should be at the lane lines of the pavement. Longitudinal joints below the surface shall be offset from previously constructed joints by approximately 6" and be located within 12" of the lane line. For adjacent lays, the paver screed does not overlap the adjoining lay and is carried slightly higher to allow for compaction of the new lay to match the adjoining lay. The raker uses a lute to remove the excess material from the previous lay into the new lay to obtain a tight, smooth joint and to prevent the rollers from compacting this material into the cold mat. The paver attempts to place the material in such a way that no luting is necessary.

### **SAFETY EDGE**

A safety edge (Figure 5-5) is a wedge of asphalt mixture placed at the edge of the pavement that results in a 30 - 35° angle of mixture. A safety edge should be constructed at locations where a dense graded intermediate mixture or a surface mixture is constructed adjacent to an aggregate or earth shoulder. The purpose of the safety edge is to provide a means for a vehicle to leave or access the edge of pavement and therefore reduce roadway departure accidents.



*Figure 5-5 Safety Edge*

### **COMPACTION**

Compaction of HMA mixes is conducted with steel wheel, pneumatic tired, vibratory, or oscillatory rollers in three phases:

1. Breakdown or initial rolling
2. Intermediate rolling
3. Finish rolling

Both vibratory and tamper-type paver screeds begin the compaction of the mix as the material flows under the screed. Breakdown rolling compacts the material beyond that imparted by the paver, intermediate rolling compacts and seals the surface, and finish rolling removes the roller marks and other blemishes left from the previous rolling.

#### ***Breakdown Rolling***

For example, when a single lane is being placed, the outside edge (the low side) of the lane is rolled first. When placing a new course adjacent to the existing lay, the longitudinal joint is rolled first followed by the breakdown rolling on the low edge.

In general, the roller proceeds straight into the un-compacted mix and returns in the same path, however, when the roller stops and reverses direction the roller should be at an angle to the pavement. The turning movement is normally completed on previously compacted material. The drive wheel of the roller is toward the paver because there is less tendency for

the mix to shove under the drive wheel. The recommended pattern for breakdown rolling is illustrated in Figure 5-6.

After the required passes for the breakdown rolling are completed, the roller is moved to the outside of the lane on the cooled portion of the course to repeat the process on the next segment.

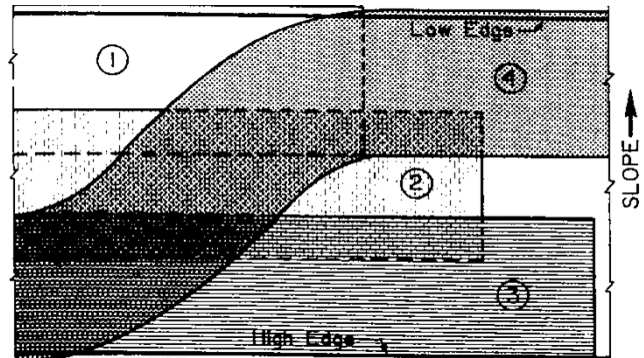

Figure 5-6 Breakdown Rolling Pattern

### **Intermediate Rolling**

Intermediate rolling is conducted immediately after the breakdown rolling while the mix is still hot and at a temperature that results in maximum density. The rolling pattern is the same pattern as done for the breakdown rolling.

Keeping the tires hot helps prevent the newly laid material from sticking to the tires for the pneumatic-tired roller. Intermediate rolling is continuous until compaction is attained. If the mixture is accepted in accordance with Section 402, the rolling pattern is established by the specifications.

### **Final Rolling**

Final rolling is conducted to improve the surface texture. This rolling is completed while the course is still warm enough so roller marks from the breakdown and intermediate compaction are removed.

### **Specified Rollers**

Compaction may be controlled by the number of passes of a specified series of rollers (Section 402) or by density (Section 401 and 410). The QCP for the contract is required to specify the type of rollers to be used. Sufficient rollers are required to be operated to complete the compaction before the temperature of the mix has cooled to a point where the density cannot be obtained.

The rolling operation is required to obtain a fully compacted mat. If the necessary compaction is not attained, subsequent traffic may consolidate the course further resulting in wheel ruts. Some mixtures, designated as "tender mixtures", may have a temperature range whereby after the initial breakdown passes, rolling is required to cease until the temperature drops to an acceptable level. Otherwise, the course may be damaged and/or any density attained by initial breakdown may be lost. Monitoring compaction during the first day of paving is critical to obtain the necessary density.

Section 402.15 for non-QC/QA mixtures allows the Contractor to designate the type of rollers used. Option No. 1 requires a three wheel roller, followed by a pneumatic tire roller and a tandem roller. Options 2, 3, 4, and 5 include different roller and roller application combinations. A roller pass is defined as one complete coverage by the roller of a given area. The various options for rolling are included in the following Table 5-2 Applications by Roller Type.

Refer to Chapter Three: Paving Equipment for more detailed information on roller types.

Number of Roller Applications							
Rollers	Courses ≤ 440 lb/yd <sup>2</sup>					Courses > 440 lb/yd <sup>2</sup>	
	Option 1	Option 2	Option 3	Option 4	Option 5	Option 1	Option 2
Three Wheel	2		4			4	
Pneumatic Tire	2	4				4	
Tandem	2	2	2			4	
Vibratory				6			8
Oscillatory					6		

**Note:** A roller application is defined as one pass of the roller over the entire mat

*Table 5-2 Applications by Roller Type*

### **Plant Production – Number of Rollers**

Before the contract begins, verification of a sufficient number of rollers and haul trucks to keep pace with the anticipated plant production is necessary. This procedure is documented in the Quality Control Plan required for the project.

### **Compaction Controlled by Density**

For all QC/QA (Section **401**) and SMA (Section **410**) mixtures, density is determined by cores obtained from the course after all rolling is complete except for the following locations:

1. The total planned lay rate to be placed over a shoulder existing prior to the contract is less than 385 lb/yd<sup>2</sup>
2. The first lift of material placed at less than 385 lb/yd<sup>2</sup> over a shoulder existing prior to the contract award

If cold weather paving is allowed, the density is also determined by cores per Section **402.16**.

Quality control procedures for density control are to be included in the QCP in accordance with **ITM 803**. Non-destructive density testing is required except for cores taken to correlate the density gauge and quality control cores defined in the QCP. Each non-nuclear gauge is calibrated in accordance with the manufacturer's recommendations and correlated to the type of mixture being placed, depth of mixture, and possibly the underlying base materials. Near the beginning of the paving operation, an area may be designated for testing to determine the proper rolling patterns to achieve the target density. This area is commonly referred to as a "test strip". Non-destructive tests are taken and cores obtained at the same locations in the test strip. The difference between the gauge readings and the measured core densities is determined and used for an "offset" for the gauge.

Non-QC/QA mixture density is controlled by the specified rolling option, per Section **402.15**.

### ***Transverse Joints***

The ramp section and paper from the day joint are required to be removed prior to resuming. The screed is set higher than the previously laid course to allow for compaction. When the paver has moved away from the joint, any mix on the surface of the old course is butted into the joint with a lute. The joint is first rolled transversely with the roller compacting on the old course and extending into the uncompacted mix about 6". Pinching the material into the joint in this way helps attain a tight joint. Planks perpendicular to the lay are used to support the roller to prevent breaking down the edge of the course while rolling in the transverse direction. Rolling is continued transversely until about 3 ft of the new lay has been rolled.

The roller is then turned parallel to the lay down and rolling is continued. The joint is required to be checked with a straightedge. The roller usually smooths out a bump while the mix is still warm by rolling transversely. Additional material may be required if the straightedge indicates a dip. Material may be added by hand, leveled with a lute, and then re-rolled to correct a dip. However, adding material tends to produce poorer quality surface texture.

### ***Longitudinal Joints***

Section **402** requires that the longitudinal joint be compacted in accordance with the following:

1. For confined edges, the first pass adjacent to the confined edge, the compaction equipment shall be entirely on the hot course 6" from the confined edge
2. For unconfined edges, the compaction equipment shall extend 6" beyond the edge of the hot mat

Another technique for the construction and compaction of the longitudinal joint that may be used for mixtures placed in accordance with Section **401** and **410** is explained as follows:

1. Uncompacted/hot HMA abutting a rolled/cold course is placed  $\frac{1}{4}$ " per 110 lb/yd<sup>2</sup> higher than the rolled/cold mat
2. Any excess HMA placed on top of the rolled/cold course is required to be removed (or luted off) from the rolled/cold course prior to compaction.
3. The most efficient way to compact the longitudinal joint is to put the roller on the hot course and overlap the joint by approximately 6" over the cold mat. The entire width of the course is required to receive a uniform number of passes of the compaction equipment. If the hot course is tender with pushing and shoving during the compaction operation, the rolling operation is required to be delayed until the course becomes stable under the roller

QC/QA HMA mix does not have a specific roller pattern for longitudinal joints, but density cores can be taken with 3" of joint.

---

## **ASPHALT EMULSION STRUCTURAL TREATMENTS**

The following asphalt emulsion structural treatments are used to bond or seal paving courses within the entire pavement structure.

### ***JOINT SEALANT***

Joint sealant, commonly referred to longitudinal fog seal, is used in conjunction with a joint adhesive to prevent water from penetrating the pavement structure. Because of the difficulty

in compacting the asphalt mixture at the longitudinal joint, joint sealant is applied to assist in sealing the material on each side of the joint, for a minimum width of 24" across the center of the joint. If a milled centerline corrugation is applied, the joint sealant will seal any cut aggregates that may occur because of the corrugations. The sealant shall be applied at an application rate of  $0.03 \pm 0.01$  gal. /sq. yd. onto a dry surface, free of any foreign or loose material, using a distributor in accordance with Section **409.03(a)**. Section **401.15** provides additional information on material and construction requirements.

### ***JOINT ADHESIVE***

Joint adhesive is required between adjacent mats to provide a waterproof seal at the joint. The joint adhesive is a hot asphalt material that is applied using a wand applicator on the joint face  $\frac{1}{8}$ " thick at the temperature recommended by the manufacturer. The application of the adhesive is made within the same day, but at least 30 minutes prior to construction of the longitudinal joint. Section **401** and **906** includes the material and construction requirements for joint adhesive.

---

---

# CHAPTER SIX: *THICKNESS AND TONNAGE CONTROL*

---

---

The lay rates (thickness) and width of the paving operation are shown on the typical sections in the contract plans or the Contract Information Book. Lay rates are used to define the thickness of the layers of the pavement. The actual compacted thickness of the course is required to conform to the planned design. The design thickness is determined so the pavement is strong enough to carry the anticipated traffic. If the course is too thin, the pavement will likely fail prematurely. If the course is too thick, the pay quantities will overrun and increase the cost of the contract unnecessarily.

The thickness of the course is checked by verifying the uncompacted thickness behind the paver and by verifying the actual lay rate (sometimes called yield).

The plans specify the rate in pounds per square yard that the HMA is to be placed. This is known as the "Planned Lay Rate". The planned quantity lay rate is used in the rate of spread and verifying the design thickness.

---

## MIXTURE ADJUSTMENT FACTOR

A Mixture Adjustment Factor (MAF) is used to adjust the mixture planned quantity and lay rate prior to paving operations, and the pay quantity upon completion of production of the mixture. The MAF is a means of adjusting lay rates to the design thickness due to materials with different densities and is a two-step calculation process. First, the MAF is calculated by dividing the maximum specific gravity ( $G_{mm}$ ) from the mixture design by the following values:

Mixture	Maximum Specific Gravity
9.5 mm	2.465
12.5 mm	2.500
19.0 mm	2.500
25.0 mm	2.500

Step two is determined by applying a correction value to step one's calculated MAF value. If the calculated MAF is equal to or greater than 0.980 and equal to or less than 1.020, the MAF value is considered to be 1.000. If the calculated MAF is less than 0.980, then 0.020 is added to the value. If the calculated MAF is greater than 1.020, 0.020 is subtracted from the value. The planned quantity and lay rate are adjusted by multiplying by the MAF. The accepted quantity for payment is adjusted by dividing by the MAF.

The MAF does not apply to open graded mixtures, temporary HMA, HMA patching and widening, HMA approaches and sidewalks, structure installation, and underdrains.

**EXAMPLE**

Calculate the Mixture Adjustment Factor (MAF) to determine the Adjusted Pay Quantity, given:

- Mix Des & Course = 9.5 mm Surface
- Planned Quantity = 9750.00 tons
- Placed Quantity = 9500.00 tons
- Mix Design Gmm = 2.360
- Lay Rate = 165 lb/yd<sup>2</sup>

Solution:

$$\text{MAF} = \frac{\text{Mix Design Gmm}}{\text{Max Specific Gravity}} = \frac{2.360}{2.465} = \mathbf{0.957}$$

$$\text{MAF}^* = 0.957 + 0.020 = \mathbf{0.977}$$

\*Using adjustment factors stated above

$$\text{Adjusted Planned Quantity} = 0.977 \times 9750.00 = \mathbf{9525.75 \text{ tons}}$$

$$\text{Adjusted Lay Rate} = 0.977 \times 1.65 \text{ lb/yd}^2 = \mathbf{161 \text{ lb/yd}^2}$$

$$\text{Adjusted Pay Quantity} = \frac{9500.00}{0.977} = \mathbf{9723.64 \text{ tons}}$$

**DETERMINING COURSE THICKNESS**

Before conducting any depth checks, the required course thickness needs to be determined. Through historical experience, HMA mixes have indicated that 110 lb/yd<sup>2</sup> is equivalent to approximately 1" of compacted depth when the MAF is approximately equal to 1.0. Mixes made with some aggregates such as slag, weigh somewhat less or more depending on the type of aggregate used.

The formula for determining the compacted course thickness in inches is:

$$\frac{\text{Planned Lay Rate (lb/yd}^2\text{)}}{110 \text{ lb/yd}^2} \quad \text{OR} \quad \frac{\text{Adjusted Lay Rate (lb/yd}^2\text{)}}{\text{MAF} \times 110 \text{ lb/yd}^2}$$

**EXAMPLE**

Determining the compacted course thickness, given:

- Planned Lay Rate = 165 lb/yd<sup>2</sup>
- Adjusted Lay Rate = 161 lb/yd<sup>2</sup>
- MAF = 0.977

Solution #1 – use Planned Lay Rate:

$$\frac{\text{Planned Lay Rate (lb/yd}^2\text{)}}{110 \text{ lb/yd}^2} = \frac{165 \text{ lb/yd}^2}{110 \text{ lb/yd}^2} = \mathbf{1.5 \text{ in}}$$

Solution #2 – use Adjusted Lay Rate:

$$\frac{\text{Adjusted Lay Rate (lb/yd}^2\text{)}}{\text{MAF} \times 110 \text{ lb/yd}^2} = \frac{161 \text{ lb/yd}^2}{0.977 \times 110 \text{ lb/yd}^2} = \mathbf{1.5 \text{ in}}$$



---

## DEPTH CHECKS

The approximate thickness of the uncompacted course is checked immediately behind the paver screed and at various points across the lane. Uncompacted course (loose mix) is placed approximately  $\frac{1}{4}$  inch additional thickness per inch of depth placed. For example, a compacted thickness of 3 inches will be placed  $3\frac{3}{4}$  inches behind the paver uncompacted. Depth checks are made regularly and are useful in determining if particular areas on the grade or pavement differ greatly from the typical cross sections. An excessively thin or thick course does not compact properly. A course too thin drags the mix aggregate. A course too thick is difficult to compact to the required density. Adjustments to the paver may be required for the depth of mix. If the problem is extensive, the slope of the pavement or the planned thickness may need to be adjusted.

---

## ACTUAL RATE OF SPREAD

The determination of the actual rate of spread is a more accurate method of determining the mixture placed than individual depth checks because the rate of spread considers the average spread over a longer paving area.

Weigh tickets are collected as the mix is delivered to the paving site and a record is kept of the actual amount of mix placed. This record is used to determine the "Placed Quantity" and compare this quantity to the "Planned Quantity".

The actual rate of spread is computed and compared to the planned rate. The planned rate is typically shown on the plans in pounds per square yard. The actual rate of spread may be computed in pounds per linear foot, tons per linear foot, or pounds per square yard. Both the planned and actual rates are required to be in the same units for valid comparison.

The purpose of computing the actual rate of spread is to determine if the planned amount is being placed. If the actual rate exceeds the planned rate, too much mix is being placed and there is an overrun of material. If the actual rate is less than the planned rate, too little mix is being placed and there is an underrun. In either case, adjustments are required to be made to bring the actual quantity in line with the planned quantity.

The two components to determine actual rate of spread are:

1. Length of segment paved which is calculated by stationing
2. Quantity of mix placed which is calculated by truck weigh tickets

### **STATIONING**

Projects are surveyed and staked in 100 ft increments called *stations*. Station 1 is written as 1+00, Station 25 as 25+00, and so on. Station 25+00 would equal 2500 ft from a fixed reference point or datum.

The use of stations makes the determination of distance paved relatively easy. If the paving started at Station 25+00 and ended at Station 60+00, there would be 3500 ft (6000 minus 2500) of mix paved. To be more precise, the distance from the actual starting or ending point to a station is determined and added or subtracted from the station referenced. For example, if the paving started 75 ft past Station 25+00, the starting point would be 25+75, or 2575 ft from

the fixed reference point. If the ending point was 40 ft beyond Station 60+00, or 60+40, the distance paved would be 6040 minus 2575, or 3465 ft.

**WEIGH TICKETS**

A weigh ticket which shows the net weight of the material is required to be furnished for every load of mix delivered to the paving site. The weigh ticket is issued to the truck driver at the weighing site. The weigh tickets also show the cumulative tonnage delivered each day. Weigh tickets are collected from the truck driver by a Department technician for each load at the same time the material is unloaded at the paving site.

Upon taking the ticket, it is advantageous to record the ticket’s starting station of the load and the lane (right, left, or center) where the material is placed. A preferred method of designating lanes is EBPL (eastbound passing lane), EBDL (eastbound driving lane), etc. Sign the original ticket after checking the appearance of the mix and verifying all information on the ticket is applicable to the project.

**COMPUTING RATES OF SPREAD**

As stated above, there are several methods of computing the actual rate of spread. The calculations differ primarily in the units in which the rates are expressed. The four methods express rate of spread in the following ways:

**Method 1 – Pounds per Square Yard** (industry standard)

**Method 2 – Pounds per Linear Foot**

**Method 3 – Tons per Linear Foot**

**Method 4 – Linear Feet Covered per Truck Load**

When the MAF is not equal to 1.000, the adjusted lay rates and adjusted planned quantities should be used for the comparisons below.

Before explaining these methods, the relationship of the different areas used in each of the four methods is required. As indicated in Figure 6-1, 9 ft<sup>2</sup> equals 1 yd<sup>2</sup>, and the number of square yards in a linear foot depends on the width being paved.

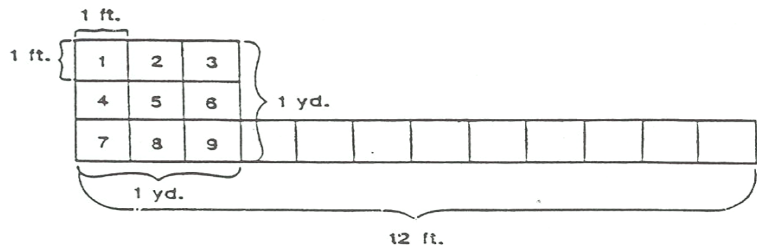

Figure 6-1 Conversion Visual Aid

The formula for determining the relationship per linear foot is:

$$\frac{1 \text{ ft} \times \text{width (ft)}}{9 \text{ ft}^2/\text{yd}^2}$$

So for a width of 12 ft (as shown), the square yards per linear foot would be:

$$\frac{1 \text{ ft} \times 12 \text{ ft}}{9 \text{ ft}^2/\text{yd}^2} = 1.33 \text{ yd}^2/\text{lft}$$

Use the quantities shown in Figure 6-2 for the following examples.

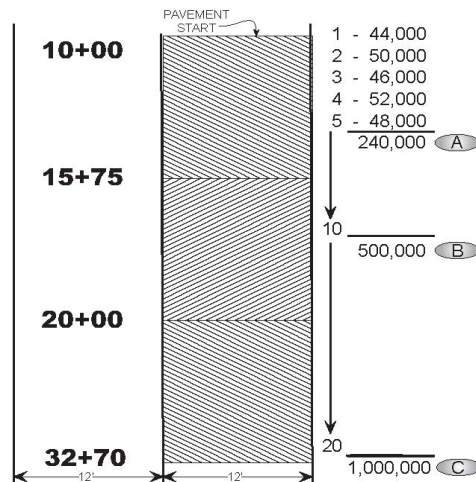

Figure 6-2 Example Paving Diagram

**METHOD 1 – POUNDS PER SQUARE YARD**

Question #1: Determine the quantity placed at the end of the first 5 loads and determine if the course is on track with planned quantity lay rate or not, given:

Plan Qty lay rate	=	330 lb/yd <sup>2</sup>	Cumulative weight	=	240,000 lb
Start Station	=	10+00	End Station	=	15+75

Solution:

1. Loads 1 through 5 began at Station 10+00 and end at Station 15+75. Determine the total length paved in linear feet:

$$1575 - 1000 = 575 \text{ lft}$$

2. Determine the area paved in square yards:

$$\frac{\text{Length} \times \text{Width}}{9 \text{ ft}^2/\text{yd}^2} = \frac{575 \text{ ft} \times 12 \text{ ft}}{9 \text{ ft}^2/\text{yd}^2} = 767 \text{ yd}^2$$

3. Calculate the actual rate of spread in lb/yd<sup>2</sup>:

$$\frac{\text{Mix Placed (lb)}}{\text{Area Paved (yd}^2)} = \frac{240,000 \text{ lb}}{767 \text{ yd}^2} = 313 \text{ lb/yd}^2$$

4. Compare the placed quantity lay rate and planned quantity lay rate:

If placed quantity is close to planned quantity lay rate, course rate is correct.  
 If placed quantity is greater than planned quantity lay rate, there is an overrun.  
 If placed quantity is less than planned quantity lay rate, there is an underrun.

The placed quantity lay rate of 312.9 lb/yd<sup>2</sup> is less than the Plan Qty lay rate of 330 lb/yd<sup>2</sup>, indicating an **underrun** and a course that is too thin.

Question #2: Determine the Placed Qty lay rate at the end of load 10 and determine if the course is on track with planned quantity lay rate or not, given:

Plan Qty lay rate	=	330 lb/yd <sup>2</sup>	Cumulative weight	=	500,000 lb
Start Station	=	10+00	End Station	=	20+00

Solution:

1. Loads 1 through 10 began at Station 10+00 and end at Station 20+00. Determine the total length paved in linear feet.

$$2000 - 1000 = \mathbf{1000\ lft}$$

2. Determine the area paved in square yards.

$$\frac{\text{Length} \times \text{Width}}{9\ \text{ft}^2/\text{yd}^2} = \frac{1000\ \text{ft} \times 12\ \text{ft}}{9\ \text{ft}^2/\text{yd}^2} = \mathbf{1333\ \text{yd}^2}$$

3. Calculate the actual rate of spread in lb/yd<sup>2</sup>

$$\frac{\text{Mix Placed (lb)}}{\text{Area Paved (yd}^2)} = \frac{500,000\ \text{lb}}{1333\ \text{yd}^2} = \mathbf{375\ \text{lb/yd}^2}$$

4. Compare the placed quantity lay rate and planned quantity lay rate:

The placed quantity lay rate of 375 lb/yd<sup>2</sup> is greater than Plan Qty lay rate of 330 lb/yd<sup>2</sup>, indicating an **overrun** and a course that is too thick.

Question #3: Determine the Placed Qty lay rate at the end of load 20 and determine if the course is on track with planned quantity lay rate or not, given:

Plan Qty lay rate	=	330 lb/yd <sup>2</sup>	Cumulative weight	=	1,000,000 lb
Start Station	=	10+00	End Station	=	32+70

Solution:

1. Loads 1 through 20 began at Station 10+00 and end at Station 32+70. Determine the total length paved in linear feet.

$$3270 - 1000 = \mathbf{2270\ lft}$$

2. Determine the area paved in square yards.

$$\frac{\text{Length} \times \text{Width}}{9\ \text{ft}^2/\text{yd}^2} = \frac{2270\ \text{ft} \times 12\ \text{ft}}{9\ \text{ft}^2/\text{yd}^2} = \mathbf{3027\ \text{yd}^2}$$

3. Calculate the actual rate of spread in lb/yd<sup>2</sup>

$$\frac{\text{Mix Placed (lb)}}{\text{Area Paved (yd}^2)} = \frac{1,000,000\ \text{lb}}{3027\ \text{yd}^2} = \mathbf{330.4\ \text{lb/yd}^2}$$

4. Compare the placed quantity lay rate and planned quantity lay rate:

The placed quantity lay rate of 330.4 lb/yd<sup>2</sup> approximately equals Plan Qty lay rate of 330 lb/yd<sup>2</sup>, indicating the spread rate is correct – no adjustment required.

### **METHOD 2 – POUNDS PER LINEAR FOOT**

**Question:** Determine the quantity placed lay rate at the end of the first 5 loads and determine if the course is on track with planned quantity lay rate or not, given:

$$\begin{array}{ll} \text{Plan Qty lay rate} & = 330 \text{ lb/yd}^2 & \text{Cumulative weight} & = 240,000 \text{ lb} \\ \text{Start Station} & = 10+00 & \text{Length Paved} & = 575 \text{ lft} \end{array}$$

**Solution:**

1. Convert the planned quantity lay rate from lb/yd<sup>2</sup> to lb/lft

$$\frac{1 \text{ ft} \times \text{Width}}{9 \text{ ft}^2/\text{yd}^2} = \frac{1 \text{ ft} \times 12 \text{ ft}}{9 \text{ ft}^2/\text{yd}^2} = 1.33 \text{ yd}^2/\text{lft}$$

$$\text{Plan lay rate} \times \text{yd}^2/\text{lft} = 330 \text{ yd}^2/\text{lft} \times 1.33 \text{ yd}^2/\text{lft} = \mathbf{440 \text{ lb/lft}}$$

2. Calculate the actual rate of spread in lb/lft

$$\frac{\text{Mix Placed (lb)}}{\text{Length Paved (lft)}} = \frac{240,000 \text{ lb}}{575 \text{ lft}} = \mathbf{417.4 \text{ lb/lft}}$$

3. Compare the placed quantity lay rate and planned quantity lay rate:

The placed quantity lay rate of 417 lb/lft is less than the planned quantity lay rate of 440 lb/lft, indicating an **underrun** and a course that is too thin.

Now use Figure 6-2 quantities to determine the rate of spread after both 10 and 20 trucks.

### **METHOD 3 – TONS PER LINEAR FOOT**

**Question:** Determine the quantity placed lay rate at the end of the first 5 loads and determine if the course is on track with planned quantity lay rate or not, given:

$$\begin{array}{ll} \text{Plan Qty lay rate} & = 330 \text{ lb/yd}^2 & \text{Cumulative weight} & = 240,000 \text{ lb} \\ \text{Start Station} & = 10+00 & \text{End Station} & = 15+75 \end{array}$$

**Solution:**

1. Convert the planned quantity lay rate from lb/yd<sup>2</sup> to ton/lft

$$\frac{\text{Plan Qty lay rate} \times \text{Width paved}}{9 \text{ ft}^2/\text{yd}^2 \times 2000 \text{ lb/ton}} = \frac{330 \times 12}{18,000} = \mathbf{0.22 \text{ ton/lft}}$$

2. Loads 1 through 5 began at Station 10+00 and end at Station 15+75. Determine the total length paved in linear feet.

$$1575 - 1000 = \mathbf{575 \text{ lft}}$$

3. Convert cumulative weight from lbs to tons

$$\frac{\text{Mix Placed (lb)}}{2,000 \text{ lb/ton}} = \frac{240,000}{2,000} = \mathbf{120 \text{ tons}}$$

4. Calculate the Theoretical Quantity in tons for the total length paved.

$$\begin{aligned} \text{Plan Qty (ton/lft)} \times \text{Length paved (lft)} & = \\ 0.22 \text{ t/lft} \times 575 \text{ lft} & = \mathbf{126.5 \text{ tons}} \end{aligned}$$

- Calculate the net over/under by comparing Placed Qty to Theoretical Qty:

If the difference is close to zero, course rate is correct

If more tons were placed than the theoretical quantity, there is an overrun

If fewer tons were placed than the theoretical quantity, there is an underrun

$$\text{Placed Qty} - \text{Theoretical Qty} = 120 \text{ t} - 126.5 \text{ t} = -6.5 \text{ tons}$$

The placed quantity of 120 tons is less than the theoretical quantity of 126.5 tons, indicating an **underrun** and a course that is too thin.

- Calculate the percent over- or underrun using the following formula:

$$\frac{\text{net over/under (tons)} \times 100}{\text{Theoretical Qty (tons)}} = \frac{-6.5 \text{ t} \times 100}{126.5 \text{ t}} = -5.14\%$$

The percent over/underrun of -5.14% indicates an **underrun of 5.14%**.

Repeat Method 3 using Figure 6-2 quantities after both 10 and 20 trucks.

#### **METHOD 4 – LINEAR FEET COVERED PER TRUCK LOAD**

Question: Determine the theoretical length of HMA paving per truck, given:

$$\text{Plan Qty lay rate} = 330 \text{ lb/yd}^2 \quad \text{Width Paved} = 12 \text{ ft}$$

Assume a typical tri-axle truck contains a net weight of approximately 20 tons of HMA.

Solution:

- Convert a truckload from tons to pounds.

$$20 \text{ tons} \times 2000 \text{ lb/ton} = 40,000 \text{ lb}$$

- Divide that by the Plan Qty lay rate to find the yd<sup>2</sup> a truckload will cover.

$$\frac{\text{lbs per truck}}{\text{Plan Qty lay rate}} = \frac{40,000 \text{ lb}}{330 \text{ lb/yd}^2} = 121 \text{ yd}^2 \text{ per truck}$$

- Convert the square yards to square feet.

$$121.2 \text{ yd}^2 \times \frac{9 \text{ ft}^2}{1 \text{ yd}^2} = 1090.9 \text{ ft}^2 \text{ per truck}$$

- Divide by Width paved to find the length covered in feet.

$$\frac{\text{ft}^2 \text{ per truck}}{\text{Width paved}} = \frac{1090.9 \text{ ft}^2}{12 \text{ ft}} = 90.9 \text{ lft per truck}$$

- Compare the placed length and theoretical length over any number of trucks:

If placed length equals theoretical length, course rate is correct

If placed length is less than theoretical length, there is an overrun

If placed length is greater than theoretical length, there is an underrun

---

---

# CHAPTER SEVEN: *QUALITY ASSURANCE*

## *PROCEDURES AND SAMPLING*

---

---

The acceptance criteria for QC/QA HMA set out in the Quality Assurance Specifications are based on binder content, air voids @  $N_{des}$ ,  $V_{be}$  @  $N_{des}$ , density and smoothness. The Specifications establish controls for temperature of the mixture and testing of aggregates and binder. The acceptance criteria for HMA mixtures are based on binder content ( $V_{be}$ ) and air voids. The acceptance criteria for SMA mixtures are binder content and gradation.

This section includes the procedures for obtaining acceptance samples and minimum requirements for mixture properties in accordance with Section **401** for QC/QA HMA and Section **410** for SMA.

---

### DESIGN MIX FORMULA

The HMA Producer must have an approved Design Mix Formula (DMF) for each mixture expected to be used on a project. The District Testing Engineer's (DTE) approves DMFs based on how the Producer and Contractor intend to use the mix. DMFs must be submitted, approved, and assigned to a Contract/CLN in *DMF Entry* prior to being allowed for use by the Contractor on a specific contract item. The DMF must be approved by the DTE for the given use-case prior to paving, and should match the contract item's information (i.e. mix type, category, size, and PG Binder grade). HMA and SMA mix design are available for review in *DMF Entry*, in addition to some specialty mix types not covered in this manual.

---

### LOTS AND SUBLOTS

QC/QA HMA and SMA are broken into lots and sublots for testing, acceptance, and payment.

#### ***QC/QA HMA***

For QC/QA HMA, a lot is 5,000 tons of base or intermediate or 3,000 tons of surface. Each lot of QC/QA HMA consists of 5 sublots, with exceptions noted below. Each base or intermediate subplot is 1,000 tons, and each surface subplot is 600 tons.

When paving is complete, partial sublots of 100 tons or less are added to the previous subplot, making an extended subplot, while partial sublots of more than 100 tons constitute a full subplot. Additionally, when paving is complete, partial lots of 4 or fewer sublots are added into the previous lot, making an extended lot of up to 9 sublots. A lot of QC/QA HMA may not have fewer than 5 sublots unless it is the only lot to be paved.

#### ***QC/QA SMA***

For QC/QA SMA, a lot is 4,000 tons of intermediate or 2,400 tons of surface. Each lot of QC/QA SMA consists of 4 sublots, with exceptions noted below. Each intermediate subplot is 1,000 tons, and each surface subplot is 600 tons.

When paving is complete, partial sublots of 100 tons or less are added to the previous subplot, making an extended subplot, while partial sublots of more than 100 tons constitute a full subplot. A lot of QC/QA may have fewer than, but will never have more than, 4 sublots.

---

## QC/QA SAMPLE TYPES

Sampling QC/QA HMA and SMA is required to determine the pay adjustment factor for placed material. Samples are required by the Department, and our sampling procedures allow for corresponding samples to be taken and tested by the producer.

### **PLATE SAMPLES**

The Department requires plate samples to be obtained at the point-of-placement. Plate samples are obtained from the paving course via metal plates and are used to determine binder content and gradation. A number of metal plates are positioned on the paving surface before the mixture is placed in accordance with the appropriate test method for either QC/QA HMA or QC/QA SMA. Once the paver passes the plates, they are located and removed from the paving course, and the void left in the mat is re-filled and smoothed manually before compaction. The mixture retained on each plate is placed in its own sample container (Figure 7-1). The sample containers will be labeled and the producer's own samples will be differentiated from the Department samples. The Department representative on site will take immediate possession of the Department samples, which will be shipped for testing.

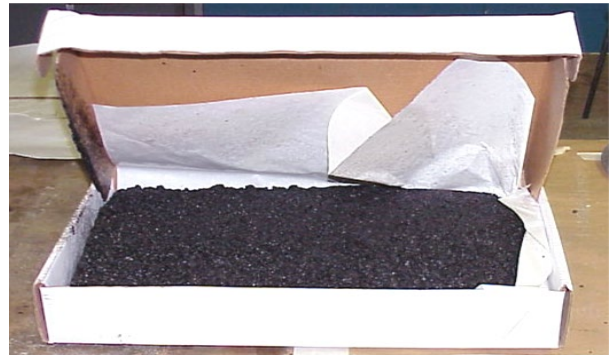

*Figure 7-1 HMA Sample Container*

### **CORE SAMPLES**

Core samples (Figure 7-2) are taken from compacted pavement to determine the density of the QC/QA HMA and SMA mixtures. The Contractor is required to obtain these samples in the presence of a Department representative, who will take immediate possession of the Department samples, which will be shipped for testing.



*Figure 7-2 Core Sample*

### **APPEAL SAMPLES**

Appeal samples are samples obtained for testing when the Contractor does not agree with the Department's acceptance test results. The Contractor is required to submit QC data prior to receiving QA results. If the QC test results do not agree with the acceptance test results per Section **401.20**, the Contractor may appeal the Department's results. Additional appeal cores may need to be taken, and/or the stored appeal plate sample will be sent in for testing. The appealed samples' test results are final.



## TRUCK SAMPLES

Truck samples (Figure 7-3) are HMA samples taken directly from the truck before placement on a contract. This type of sampling is often done by the Contractor at the plant to obtain information about the HMA quickly, but may also be done by INDOT for non-QC/QA HMA to verify the acceptance Certification. Truck sampling is conducted in accordance with **ITM 580** and is rarely seen on-site.



Figure 7-3 Truck Sampling

## ACCEPTANCE SAMPLING PROCEDURES

The first step in acceptance sampling is determining when and where to take the sample. This process is done randomly so that all of the mixture has a chance of being sampled and to ensure the Contractor that there is no bias in obtaining the sample. The first 300 tons of a DMF are exempt from sampling, although they do count toward the first subplot's quantity. The following examples use intermediate rounding for clarity, although field use wouldn't.

### RANDOM NUMBERS

Sampling for acceptance is done using **ITM 802**. Included with the test method is a table of random numbers used to determine the random quantity or location (Figure 7-4). The numbers in this table can be thought of as percentages and occur in no particular order. Therefore, samples obtained by the use of this table are truly random, eliminating bias. **ITM 802** also allows the use of a Department-approved random number generator software in the form of the Field Assistant HMA Tracker template. The randomly-generated numbers must not be made available to the Contractor.

To use the random number table for testing, select, without looking, one block in the table. After selecting the block, the top left number in the block is the first random number used.

0.576	0.730	0.430	0.754	0.271	0.870	0.732	0.721	0.998	0.239
0.892	0.948	0.858	0.025	0.935	0.114	0.153	0.508	0.749	0.291
0.669	0.726	0.501	0.402	0.231	0.505	0.009	0.420	0.517	0.858
0.609	0.482	0.809	0.140	0.396	0.025	0.937	0.310	0.253	0.761
0.971	0.824	0.902	0.470	0.997	0.392	0.892	0.957	0.040	0.463
0.053	0.899	0.554	0.627	0.427	0.760	0.470	0.040	0.904	0.993
0.810	0.159	0.225	0.163	0.549	0.405	0.285	0.542	0.231	0.919
0.081	0.277	0.035	0.039	0.860	0.507	0.081	0.538	0.986	0.501
0.982	0.468	0.334	0.921	0.690	0.806	0.879	0.414	0.106	0.031
0.095	0.801	0.576	0.417	0.251	0.884	0.522	0.235	0.389	0.222
0.509	0.025	0.794	0.850	0.917	0.887	0.751	0.608	0.698	0.683
0.371	0.059	0.164	0.838	0.289	0.169	0.569	0.977	0.796	0.996
0.165	0.996	0.356	0.375	0.654	0.979	0.815	0.592	0.348	0.743
0.477	0.535	0.137	0.155	0.767	0.187	0.579	0.787	0.358	0.595
0.788	0.101	0.434	0.638	0.021	0.894	0.324	0.871	0.698	0.539
0.566	0.815	0.622	0.548	0.947	0.169	0.817	0.472	0.864	0.466
0.901	0.342	0.873	0.964	0.942	0.985	0.123	0.086	0.335	0.212
0.470	0.682	0.412	0.064	0.150	0.962	0.925	0.355	0.909	0.019
0.068	0.242	0.777	0.356	0.195	0.313	0.396	0.460	0.740	0.247
0.874	0.420	0.127	0.284	0.448	0.215	0.833	0.652	0.701	0.326
0.897	0.877	0.209	0.862	0.428	0.117	0.100	0.259	0.425	0.284
0.876	0.969	0.109	0.843	0.759	0.239	0.890	0.317	0.428	0.802
0.190	0.696	0.757	0.283	0.777	0.491	0.523	0.665	0.919	0.246
0.341	0.688	0.587	0.908	0.865	0.333	0.928	0.404	0.892	0.696
0.846	0.355	0.831	0.218	0.945	0.364	0.673	0.305	0.195	0.887
0.882	0.227	0.552	0.077	0.454	0.731	0.716	0.265	0.058	0.075
0.464	0.658	0.629	0.269	0.069	0.998	0.917	0.217	0.220	0.659
0.123	0.791	0.503	0.447	0.659	0.463	0.994	0.307	0.631	0.422
0.116	0.120	0.721	0.137	0.263	0.176	0.798	0.879	0.432	0.391
0.836	0.206	0.914	0.574	0.870	0.390	0.104	0.755	0.082	0.939
0.636	0.195	0.614	0.486	0.629	0.663	0.619	0.007	0.296	0.456
0.630	0.673	0.665	0.666	0.399	0.592	0.441	0.649	0.270	0.612
0.804	0.112	0.331	0.606	0.551	0.928	0.830	0.841	0.702	0.183
0.360	0.193	0.181	0.399	0.564	0.772	0.890	0.062	0.919	0.875
0.183	0.651	0.157	0.150	0.800	0.875	0.205	0.446	0.648	0.685

Figure 7-4 Random Number Table

Proceed down the column for additional numbers and proceed to the top of the next column on the right when the bottom of the column is reached. When the bottom of the last column on the right is reached, proceed to the top of the column at the left. If all numbers in the table are used, use one of the other provided sheets of random numbers, or select a new starting number and proceed in the same manner as before.

By using the random numbers in this manner, the first three numbers could be used to determine the random ton and coordinate for a plate sample, the next two to determine the first core location, and the two after that to determine the second core location. However you apply the random numbers to your testing, be sure to apply them consistently to avoid Contractor complaint and **DO NOT** override the random number selection process to use a predictable numbering sequence simply for convenience.

## PLATE SAMPLES

### Determining Location

The random location of a plate sample is determined by selecting three random numbers from the Random Number Table. The first will be used to generate a random ton within a subplot, and the next two to determine a sampling location, as follows:

1. To determine where to take a random sample within a subplot, take your first random number and multiply it by the maximum subplot size (either 1,000 or 600 tons). The resulting number will determine which individual truck contains your random ton
2. Once the truck containing the sample ton is identified, the sample station is determined by multiplying the second random number by the theoretical length of pavement to be placed by that truck based on its weight (see Method 4 on page 6-8). To find the sample station, add that length to the station at which the random truck begins unloading into the paver
3. Finally, multiply the third number by the paving width and round to the nearest whole foot to determine a transverse location within the lane. This distance is measured from the right edge of the pavement when looking in the direction of increasing station numbers
4. If, while testing the very first subplot of a DMF on a CLN, the random ton is 300 or less, simply add 300 to it to move it outside of the testing restricted area. Similar adjustments may be made if a transverse location is less than 1 ft from either edge of the pavement, if the course thickness at a location is less than 2 times the maximum particle size, if the random station places a test within the exemption area (50 ft) on either side of a structure or other cold joint, or if your random transverse location falls within the wheelpath of the paver or transfer machine

Instruct the Contractor to take a plate sample at the random coordinates as determined above. Both the Contractor and Department representative who respectively obtained and witnessed the sample will be identified on the sample paperwork.

### EXAMPLE

Determine the station at which a test sample should be taken, given:

Mixture Course	= Intermediate	Random # 1	= 0.552
Width of Pavement	= 12 ft	Random # 2	= 0.629
End of previous load	= 158+00	Random # 3	= 0.503
Truck load size	= 20.18 tons	Running total	= 535.88 tons
Planned Qty	= 275 lb/yd <sup>2</sup>	Paving depth	= 2.5 in

### Solution:

1. Determine the random sample ton. An Intermediate course's sublots are 1,000 tons.

$$\text{Sublot size } (t) \times \text{Random \# 1} = 1000 \times 0.552 = \mathbf{552 \text{ tons}}$$

2. Determine remaining tons to random tonnage.

$$\text{Random sample ton} - \text{Running total} = 552 - 535.88 = \mathbf{16.12 \text{ tons}}$$

The next truck's ticket shows 20.18 tons, so it contains the random ton.

3. Determine the Length of Load for the truck being sampled.

a. Determine weight of the truck in lbs:

$$20.18 \text{ t} \times 2000 \text{ lb/t} = \mathbf{40360 \text{ lb}}$$

b. Determine the theoretical Paving area of the truck in  $\text{yd}^2$ :

$$\frac{40360 \text{ lb}}{275 \text{ lb/yd}^2} = \mathbf{146.8 \text{ yd}^2}$$

c. Convert theoretical Paving area to  $\text{ft}^2$ :

$$146.8 \text{ yd}^2 \times 9 \text{ ft}^2/\text{yd}^2 = \mathbf{1321.2 \text{ ft}^2}$$

d. Determine Length of Load in  $\text{ft}$ :

$$\frac{1321.2 \text{ ft}^2}{12 \text{ ft}} = \mathbf{110 \text{ ft}}$$

4. Find the longitudinal distance and sample Station.

$$\text{Length of Load} \times \text{Random \# 2} = 110 \times 0.629 = 69 \text{ ft}$$

$$\text{End of Previous Load} + \text{distance} = (158+00) + 69 \text{ ft} = 158+69$$

5. Find the transverse distance.

$$\text{Paving width} \times \text{Random \# 3} = 12 \text{ ft} \times 0.503 = 6 \text{ ft}$$

The random location for this plate sample is 158+69 with a 6 ft offset.

For QC/QA HMA mixes accepted by Volumetric Acceptance (Section **401**), several samples are required. The first plate (A1) sample location is determined by the random sampling procedure and this material is used for the maximum specific gravity and binder content samples. A second plate (A2) sample location is placed longitudinally 2 ft upstation from the first plate at the same transverse offset. This sample is used for the gyratory specimens. The A3 plate is used for aggregate Gsb testing.

If the Producer appeals the Department test results, the backup samples are tested. These samples are obtained at the same time as the acceptance samples. The backup sample plate (B1) for the maximum specific gravity and binder content is placed transversely 2 ft from the first plate towards the center of the mat. The backup sample plate (B2) for the gyratory specimens is placed transversely 2 ft from the second plate towards the center of the mat.

Figure 7-5 shows an example arrangement of plate samples when additional samples are required and backup samples are taken transversely from the first and second sample locations. This is the standard procedure seen on INDOT contracts. An example for determining the sample locations follows.

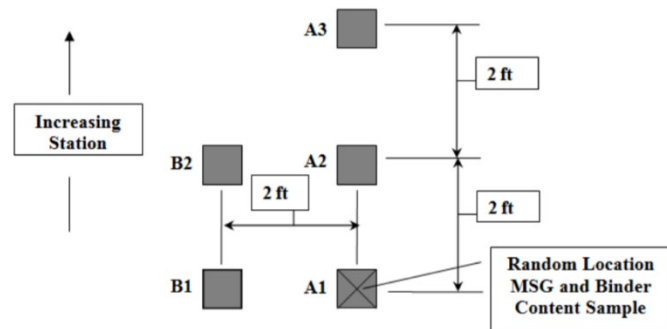

Figure 7-5 All plate samples in relation to A1 sample

### **EXAMPLE**

Determine all of the plate sample locations, given the location of the A1 plate sample from the previous example:

$$\text{Random Station} = 158+69 \qquad \text{Offset} = 6 \text{ ft}$$

#### **Solution:**

1. Find the Gyratory plate location, A2.

$$\begin{array}{ll} \text{Longitudinal} & (158+69) + 2 = \mathbf{158+71} \\ \text{Transverse} & \mathbf{6 \text{ ft}} \end{array}$$

2. Find the GSB plate location, A3.

$$\begin{array}{ll} \text{Longitudinal} & (158+69) + 4 = \mathbf{158+73} \\ \text{Transverse} & \mathbf{6 \text{ ft}} \end{array}$$

3. Find the backup plate location, B1.

$$\begin{array}{ll} \text{Longitudinal} & \mathbf{158+69} \\ \text{Transverse} & \mathbf{6 + 2 = 8 \text{ ft}} \end{array}$$

4. Find the backup plate location, B2.

$$\begin{array}{ll} \text{Longitudinal} & (158+69) + 2 = \mathbf{158+71} \\ \text{Transverse} & \mathbf{6 + 2 = 8 \text{ ft}} \end{array}$$

### ***Testing Procedures***

The procedure for obtaining plate samples (Figure 7-6) once the random location is determined is as follows:

1. A clean metal plate with attached wire is placed on the pavement. Should conditions on the contract require stabilizing movement to avoid slipping of the plate, a nail is driven into the pavement, and the plate hole placed onto the nail. A No. 18 gage mechanics wire and masonry nail has been proven to be effective for this purpose.
2. The wire is extended beyond the edge of the paving width. The wire should not pass under a grade leveler attached to the paver. Trucks, pavers, or material transfer devices are allowed to cross the plate and/or wire. If a transfer machine is used, the paving operation is stopped so that the plate may be placed between the transfer machine and the paver.
3. After the mixture is placed and before any compaction from the rollers occurs, the wire is used to locate the plate.
4. The plate is lifted with the wire, a narrow shovel or pitchfork is inserted under the plate, and the plate is lifted from the pavement.
5. The sample is then placed in a container for transport to the testing facility. Enter sample information (location w/sample number) on container and verify that the minimum sample weight is met. The material remaining on the plate is required to be removed and replaced into the sample container.



Figure 7-6 Plate Sampling: 1) Setting plates; 2) Final plate arrangement; 3) Locating plates after paving; 4) Collecting loose HMA material for testing

If the depth of the mixture is such that the material may fall off the sides of the plate when lifted from the pavement, a mold may be used with the plate – only plate or plate-and-mold procedures are allowed when collecting samples. Placement and location use the same procedure but additional requirements for the plate-and-mold method include:

1. A clean round mold, with a height greater than the mixture thickness and diameter less than the width of the plate, is pushed by means of a circular motion into the mixture directly over the plate
2. The mold and plate are raised together and a pitchfork or narrow shovel is inserted under the plate
3. The mold and plate are lifted from the pavement and any excess mixture on top of the plate and outside of the mold is discarded
4. The sample inside the mold is placed into the sample container. Material remaining on the plate is removed and placed into the sample container
5. Verify that the minimum sample weight is met

When the pavement width is 4 ft or less, the samples are obtained from the center of the course and at least 1 ft from the edge of the course.

Plate samples will not be taken at the following location:

1. Less than 1 ft from the edge of the course
2. A course thickness less than 2.0 times the maximum particle size
3. Original pay item quantity is less than 300 tons. (Does not apply to SMA)

4. Areas placed by wideners, or specialty equipment approved by the Engineer. If the random location falls within an area placed by this equipment, another randomly selected location is determined. If the entire subplot falls within an area placed by this equipment, the previous is used for acceptance. If the previous subplot is not available, the subsequent subplot will be used

Figure 7-7 indicates the approximate weight needed for various plate sizes and lift thicknesses, while Figure 7-8 indicates the same but when a mold is used with the plate to obtain the sample.

Approximate Sample Yield for Various Lift Thickness and Plate Sizes								
Lift Thickness (inches)	Lay Rate (lb/yd <sup>2</sup> )	Plate Size, inches						
		8	9	10	11	12	14	16
		Sample Weight (g)						
1.25	137.5	3100	3900	4800	5900	7000	9500	12400
1.5	165	3700	4700	5800	7000	8400	11400	14900
1.75	192.5	4300	5500	6800	8200	9800	13300	17300
2.0	220	5000	6300	7700	9400	11100	15200	19800
2.25	247.5	5600	7100	8700	10500	12500	17100	22300
2.5	275	6200	7800	9700	11700	13900	19000	27800
2.75	302.5	6800	8600	10600	12900	15300	20900	27300
3.0	330	7400	9400	11600	14100	16700	22800	29700
3.25	357.5	8100	10200	12600	15200	18100	24700	32200
3.5	385	8700	11000	13500	16400	19500	26600	34700
3.75	412.5	9300	11800	14500	17600	20900	28500	37200
4.0	440	9900	12500	15500	18700	22300	30300	39600
4.25	467.5	10500	13300	16400	19800	23600	32100	41900
4.5	495	11100	14000	17300	21000	25000	34000	44400
4.75	522.5	11700	14800	18300	22100	26400	35900	46900
5.0	550	12300	15600	19300	23300	27700	37800	49300
5.25	577.5	12900	16400	20200	24500	29100	39700	51800
5.5	605	13600	17200	21200	25600	30500	41500	54300
5.75	632.5	14200	17900	22200	26800	31900	43400	56700
6.0	660	14800	18700	23100	28000	33300	45300	59200

Figure 7-7 Approximate Sample Yield for Various Lift Thickness and Plate Sizes

Approximate Sample Yield for Various Lift Thicknesses and Mold Sizes						
Lift Thickness (inches)	Lay Rate (lb/yd <sup>2</sup> )	Mold Size, inches				
		8	10	12	14	16
		Sample Weight (g)				
1.25	137.5	2400	3800	5400	7400	9700
1.5	165	2900	4500	6500	8900	11600
1.75	192.5	3400	5300	7600	10400	13600
2.0	220	3900	6100	8700	11900	15500
2.25	247.5	4400	6800	9800	13300	17400
2.5	275	4800	7600	10900	14800	19400
2.75	302.5	5300	8300	12000	16300	21300
3.0	330	5800	9100	13100	17800	23200
3.25	357.5	6300	9800	14200	19300	25200
3.5	385	6800	10600	15300	20800	27100
3.75	412.5	7300	11300	16300	22200	29100
4.0	440	7700	12100	17400	23700	31000
4.25	467.5	8200	12900	18500	25200	32900
4.5	495	8700	13600	19600	26700	34900
4.75	522.5	9200	14400	20700	28200	36800
5.0	550	9700	15100	21800	29700	38700
5.25	577.5	10200	15900	22900	31100	40700
5.5	605	10700	16600	24000	32600	42600
5.75	632.5	11100	17400	25100	34100	44500
6.0	660	11600	18200	26100	35600	46500

Figure 7-8 Approximate Sample Yield for Various Lift Thicknesses and Mold Sizes

### CORE SAMPLING

Core sampling (Figure 7-9) is done by the Contractor under the supervision of a Department representative. For QC/QA HMA, two cores are obtained in each subplot for density of the mixture. The core locations are determined by **ITM 802** with each core located independently within the subplot. All core sampling is performed in accordance with **ITM 580**.

A 6.0 ± 0.25" diameter core is obtained from the pavement. The sample is removed from the pavement with a device that does not damage the layer to be tested. The layer to be tested is marked with a lumber crayon or permanent marker.



Figure 7-9 Taking an HMA Core Sample

To determine a random location for coring within a subplot, take a pair of random numbers selected via the procedure noted in the section *Random Numbers*, multiplying one by the theoretical length of the subplot and the other by the paving width. The resulting numbers will determine coordinates for your core sample. Of note, while cores are labeled A and B there is no order in which these must be pulled or calculated – core B will randomly occur before core A, and vice versa. Additionally, these cores may be pulled before or after the plate sample, as again, there is no specified order so long as all required samples are taken.

The random station is determined by adding the random longitudinal distance to the start station of the subplot. The transverse distance is determined using the width of the course being placed, and is measured from the right edge of the pavement when looking in the direction of increasing station numbers. Computations for the longitudinal distance are made to the nearest 1 ft and computations for the transverse distance are made to the nearest 0.1 ft. The following equation includes the conversion factor of 18,000 to account for the different units of measure, and is used to determine the length of the subplot:

$$\text{Length of Sublot} = \frac{\text{Sublot Size (tons)} \times 18000}{\text{Planned Lay Rate (lb/yd}^2\text{)} \times \text{Paving Width (ft)}}$$

Cores will not be taken in the following circumstances:

1. Less than 3" from a confined edge of the course being placed
2. Less than 6" from a non-confined edge of the course being placed
3. A course thickness less than 2.0 times the maximum particle size
4. Areas placed with wideners, or specialty equipment approved by the Engineer. If the random location falls within an area placed by this equipment, another randomly selected location is determined. If the entire subplot falls within an area placed by this equipment, the previous subplot is used for acceptance. If the previous subplot is not available, the subsequent subplot will be used for acceptance
5. Original pay item quantities less than 300 tons
6. The first lift of material placed at less than 385 lb/yd<sup>2</sup> over an existing shoulder

Use Figure 7-10 to determine core locations within each subplot of a lot and complete the example on the next page.



**EXAMPLE**

Find the station where a test sample should be taken for a single core, given:

Mixture Course	=	Surface	Random # 1	=	0.256
Width of Pavement	=	12 ft	Random # 2	=	0.561
Starting Station	=	158+00	Planned Qty	=	165 lb/yd <sup>2</sup>

Solution:

- Determine the Length of Sublot.

$$\frac{600 \times 18000}{165 \times 12} = \mathbf{5456 \text{ ft}}$$

- Find the longitudinal distance and Station.

$$\text{Length of Sublot} \times \text{Random \# 1} = 5456 \times 0.256 = 1397 \text{ ft}$$

$$\text{Starting Station} + \text{distance} = (158+00) + 1397 \text{ ft} = 171+97$$

- Find the transverse distance.

$$\text{Paving width} \times \text{Random \# 2} = 12 \text{ ft} \times 0.561 = 7 \text{ ft}$$

The random station for this core sample is 171+97 with a 7 ft offset.

Sublot No.	Longitudinal Location					Transverse Location		
	Length of Sublot (ft.)	Random Number	Random Distance (ft.)	Starting Station	Random Station	Paving Width (ft.)	Random Number	Transverse Location (ft.)
	A	B	A x B = C	D	C + D	E	F	E x F
1-A								
1-B								
2-A								
2-B								
3-A								
3-B								
4-A								
4-B								
5-A								
5-B								

Figure 7-10 Random Core Location Determination per Sublot

## THE FIELD ASSISTANT HMA TRACKER

The HMA Tracker was developed primarily to organize material ticketing and subplot tracking and to simplify the random number calculations. This is one of the many utilities found within the Field Assistant application. HMA Tracker is a built-in tracking utility that provides many time-saving features in what can be thought of as a template for HMA entry, testing, and weigh ticket recording. To utilize the HMA Tracker, your contract needs to have an HMA item with approved DMFs.

Central to the functionality of the HMA Tracker is recording your asphalt tickets as they come to the worksite. As you enter individual weigh tickets, the HMA Tracker will track your total tons for the day, the paving width as you go, the quantity placed versus the theoretical quantity, as well as track multiple lifts and notify you of upcoming plate and core samples.

Figure 7-11 shows an example from the Field Assistant user manual and how the sampled lots are displayed in the HMA Tracker application. The Field Assistant manual can be accessed from the SiteManager Manuals page on ERMS here:

<https://erms12c.indot.in.gov/sitemanagermanuals/?startkeywords=Field%20Assistant>

### 2. Sampled Lot/Sublot Tab

The *Sampled Lot/Sublot* tab will track your random samples day-by-day. The random numbers generated for Sampled Ton and Offset for today's HMA on this DWR will be saved and used for future sublots until new random numbers for additional sublots need to be generated.



The screenshot shows the 'Sampled Lot/Sublot' tab for 'Project 1006581 Tickets'. It features a search bar and a table with columns for Lot, Sublot, Sample Desc, Start Ton, Random Ton, Sampled Lot Ton, Daily Tons To Sample, Offset Loc, Sample Station, and Override. The table contains four rows of data, each with 'Add Stationing' and 'Override' buttons.

Lot	Sublot	Sample Desc	Start Ton	Random Ton	Sampled Lot Ton	Daily Tons To Sample	Offset Loc	Sample Station	Override
1	3	Plate	2000	631	2631	441	8.99	Add Stationing	Override
1	3	Core B	2000	758	2758	568	6.85	Add Stationing	Override
1	3	Core A	2000	896	2896	706	3.05	Add Stationing	Override
1	4	Core A	3000	25	3025	835	8.41	Add Stationing	Override

Figure 7-11 Field Assistant's HMA Tracker module

---

---

## **CHAPTER EIGHT: *HMA PAVING CHECKLISTS***

---

---

To summarize the many physical inspection check points that need to be reviewed on a daily basis during the placement of HMA, the following checklists were developed to help technicians quickly find and address any deficiencies. Any deficiencies should be brought to the attention of the Contractor and the Department's PEMS for discussion and remediation.

It should also be mentioned that reviewing and becoming familiar to the Contractor's quality control paving plans at the beginning of the paving season is beneficial for the technicians. The QCP will provide insight to the Contractor's means and methods of constructing the road and should reflect the requirements of **ITM 803**.

---

### **HAUL TRUCK CHECKLIST**

When a haul truck arrives to the site with HMA mix, inspect for the following:

1. Watch for material segregation during dumps
2. Watch for foreign or old/clumped material in the mix which would indicate that the beds were not clean when loaded
3. Be sure the trucks are equipped with tarps and are in place when needed to keep the material from cooling or becoming contaminated in route
4. Inspect for evidence of the excess use of approved anti-adhesive agent(s)

---

### **SURFACE PREPARATION CHECKLIST**

Before paving begins, either the day before or the day of, inspect the paving surfaces and the following inspection points have been reviewed:

1. Check for upcoming weather and that surface temperature limitations will not be exceeded
2. Any localized failures are removed and replaced
3. If paving on subbase, that all surfaces are uniform and seated
4. If milled, that the surface is smooth and to desired grade without scabs
5. All surfaces are clean and free of loose debris, dust, or standing water
6. Paint removed prior to overlay
7. Joint adhesive was properly applied to joint surfaces
8. Prime or tack coats properly applied
  - a. Uniform and adequate coverage without streaking or puddling
  - b. Minimal haul truck or paving equipment tracking of the coat
  - c. Prime or tack coat broke/matured enough for paving

---

### **HMA PLACEMENT CHECKLIST**

During the paving activity, inspect the following points:

1. Weather limitations have not been exceeded
2. When applicable, the paver is equipped to construct a safety edge
3. Continuous paving with minimal starts and stops

4. Uniform surface and texture placed behind the paver
  - a. No segregation of the mixture is visible
  - b. No excess or deficiency of binder within the mixture visible
  - c. No foreign or clumped material visible in the paving course
  - d. No pulling or tearing of the paving course
  - e. No bleeding of the mixture is visible
5. Smooth transverse transition joints with minimal tapering
6. Longitudinal joints are constructed with approximately a 6" offset from previous course
7. Plate sample locations are identified along the course of the paver
8. Where applicable, asphalt joint sealant is properly applied
9. Paving equipment and tools should be cleaned away from pavement and shoulder areas

---

## COMPACTION CHECKLIST

Things to look for during compaction:

- a. Rollers in good shape
- b. Sufficient size and number of rollers
- c. Use proper release agent on the rubber tires. No diesel fuel should be used
- d. Good rolling pattern
- e. Air temperature satisfactory
- f. Mix temperature satisfactory
- g. Mix should support rollers without lateral movement
- h. Layer thickness satisfactory
- i. Rollers keep up close behind paver
- j. Good procedures with longitudinal and transverse joints